

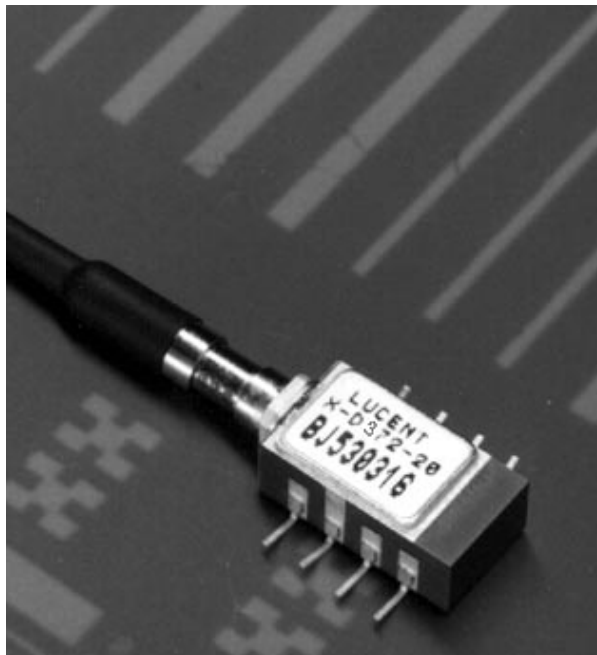

D372-Type Digital Uncooled DFB *FastLight*™ Laser Module for 2.5 Gbits/s Applications



The low-profile D372-Type Laser Module is ideally suited for OC-48 SONET and other high-speed digital applications.

Features

- 8-pin package suitable for SONET applications
- Narrow linewidth distributed feedback multiquantum-well (DFB-MQW) 1.3 μm laser with single-mode fiber pigtail
- Wide operating temperature range: $-40\text{ }^{\circ}\text{C}$ to $+85\text{ }^{\circ}\text{C}$
- No TEC required
- High output power: typical 2.0 mW peak power coupled into single-mode fiber
- Hermetically sealed active components
- Internal back-facet monitor
- Built-in thermistor and bias T
- 25 Ω input impedance
- Internal isolator
- Qualification program: Bellcore TA-983

Applications

- SONET OC-48/STM-16 systems
- Telecommunications
- Secure digital data systems

Benefits

- Easily board mounted
- Gull wing leads
- No additional heat sinks required
- Low-cost alternative to industry-standard, 14-pin isolated laser module (ILM)
- Highly efficient DFB-MQW laser structure allows for lower threshold and drive currents, and reduced power consumption

Description

The D372-Type Uncooled Laser Module consists of a laser diode coupled to a single-mode fiber pigtail. The device is available in a standard, 8-pin configuration (see Figure 1 and/or Table 1) and is ideal for long-reach (SONET) and other high-speed digital applications.

The module includes a narrow linewidth ($<1\text{ nm}$) DFB-MQW single-mode laser and an InGaAs PIN photodiode back-facet monitor in a hermetically sealed package.

This package is optimized for a 25 Ω input impedance and allows for dc biasing through an internal bias T. A thermistor has been included for feedback to board-level bias circuitry, if needed.

Description (continued)

The device characteristics listed in this document are met at 2.0 mW output power. Higher- or lower-power operation is possible. Under conditions of a fixed photodiode current, the change in optical output is typically ± 0.5 dB over an operating temperature range of -40 °C to $+85$ °C.

This device incorporates the new Laser 2000 manufacturing process from the Optoelectronic Products unit of Lucent Technologies Microelectronics Group. Laser 2000 is a low-cost platform that targets high-volume manufacturing and tighter product distributions on all optical subassemblies. This platform incorporates an advanced optical design that is produced on one of the highly automated production lines at the Optoelectronic manufacturing facility. The Laser 2000 platform is qualified for the central office and uncontrolled environments, and can be used for applications requiring high performance and low cost.

Table 1. Pin Descriptions

Pin Number	Connection
1	Thermistor
2	Thermistor, package GND
3	Laser dc bias cathode (-) choke
4	Photodiode cathode
5	Photodiode anode
6	Laser diode anode (+)
7	Laser RF input cathode (-) 25 Ω
8	Laser diode anode (+)

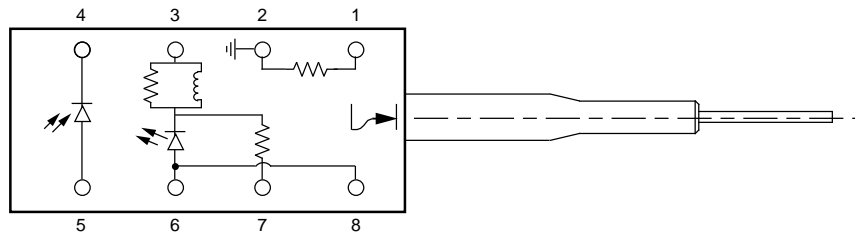

1-900.b

Figure 1. D372-Type Digital Uncooled DFB Mini 8-Pin Laser Module Schematic, Top View

Absolute Maximum Ratings

Stresses in excess of the absolute maximum ratings can cause permanent damage to the device. These are absolute stress ratings only. Functional operation of the device is not implied at these or any other conditions in excess of those given in the operations sections of the data sheet. Exposure to absolute maximum ratings for extended periods can adversely affect device reliability.

Parameter	Symbol	Min	Max	Unit
Maximum Peak Laser Drive Current or Maximum Fiber Power*	I_{OP} P_{MAX}	—	150 10	mA mW
Peak Reverse Laser Voltage:				
Laser	V_{RL}	—	2	V
Monitor	V_{RD}	—	20	V
Monitor Forward Current	I_{FD}	—	2	mA
Operating Case Temperature Range	T_C	-40	85	°C
Storage Case Temperature Range	T_{stg}	-40	85	°C
Lead Soldering Temperature/Time	—	—	260/10	°C/s
Relative Humidity (noncondensing)	RH	—	85	%

* Rating varies with temperature.

Handling Precautions

Caution: This device is susceptible to damage as a result of electrostatic discharge (ESD). Take proper precautions during both handling and testing. Follow guidelines such as JEDEC Publication No. 108-A (Dec. 1988).

Although protection circuitry is designed into the device, take proper precautions to avoid exposure to ESD.

Electro/Optical Characteristics

Table 2. Electro/Optical Characteristics (over operating temperature range unless otherwise noted)

Parameter	Symbol	Test Conditions	Min	Typ	Max	Unit
Operating Temperature Range	T	—	-40	—	85	°C
Optical Output Power	P _F	CW, peak	—	2	—	mW
Threshold Current	I _{TH}	T = 25 °C T = full range	5 2	11 —	15 50	mA mA
Modulation Current	I _{MOD}	CW, P _F = 2.0 mW, T = 25 °C CW, I _{MON} = const., T = full range	13 7.5	20 —	33 55	mA
Slope Efficiency*	SE	CW, P _F = 2.0 mW, T = 25 °C	61	—	154	μW/mA
Center Wavelength	λ _C	P _F = 2.0 mW, CW	1280	—	1335	nm
Spectral Width (-20 dB)	Δλ	P _F = 2.0 mW	—	—	1	nm
Side-mode Suppression Ratio	SMSR	CW, P _F = 2.0 mW	30	40	—	dB
Tracking Error	TE	I _{MON} = constant, CW	—	0.5	1.25	dB
Spontaneous Emission	P _{TH}	I = (0.9) I _{TH}	—	—	50	μW
Rise/Fall Times	t _R , t _F	10%—90% pulse†, T = 25 °C	—	0.125	0.150	ns
Dispersion Penalty	D _P	<60 km, 256 ps/nm	—	—	1.0	dB
Optical Return Loss	ORL	CW	18	—	—	dB
Forward Voltage	V _F	At bias coil	—	1.1	1.6	V
Input Impedance	R	—	—	25	—	Ω
Monitor Current	I _{MON}	V _R ‡ = 5 V	100	—	1000	μA
Monitor Dark Current	I _D	V _R ‡ = 5 V	—	10	200	nA
Wavelength Temperature Coefficient	—	—	—	0.09	0.1	nm/°C

* The slope efficiency is used to calculate the modulation current for a desired output power. This modulation current plus the threshold current comprise the total operating current for the device.

† Corrected for electrical pulse fall time.

‡ V_R = reverse voltage.

Qualification Information

The D372-Type Laser Module is scheduled to complete the following qualification tests and meets the intent of Bellcore TR-NWT-000468 for interoffice environments and TA-TSY-000983 for outside plant environments.

Table 3. D372-Type Laser Module Qualification Test Plan

Qualification Test	Conditions	Sample Size	Reference
Mechanical Shock	500 G	11	MIL-STD-883 Method 2002
Vibration	20 g, 20 Hz—2,000 Hz	11	MIL-STD-883 Method 2007
Solderability	—	11	MIL-STD-883 Method 2007
Thermal Shock	Delta T = 100 °C	11	MIL-STD-883 Method 2003
Fiber Pull	1 kg; 3 times	11	Bellcore 983
Accelerated (Biased) Aging	85 °C, 5,000 hrs.	25	Bellcore 983 Section 5.18
High-temperature Storage	85 °C, 2,000 hrs.	11	Bellcore 983
Temperature Cycling	500 cycles	11	Bellcore 983 Section 5.20
Cyclic Moisture Resistance	10 cycles	11	Bellcore 983 Section 5.23
Damp Heat	40 °C, 95% RH, 1344 hrs.	11	MIL-STD-202 Method 103
Internal Moisture	<5,000 ppm water vapor	11	MIL-STD-883 Method 1018
Flammability	—	—	TR357 Section 4.4.2.5
ESD Threshold	—	6	Bellcore 983 Section 5.22

Outline Diagram

Dimensions are in inches and (millimeters).

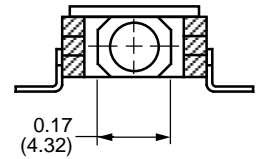
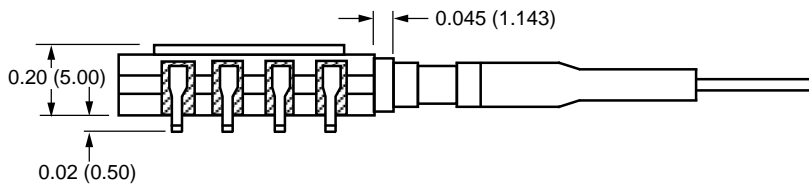
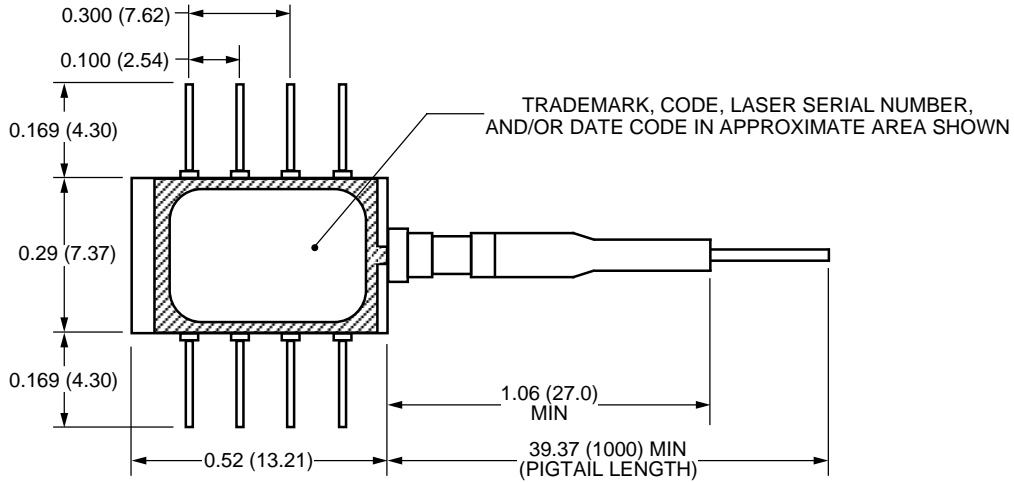

1.925.e

Laser Safety Information

Class IIIb Laser Product

This product complies with 21 CFR 1040.10 and 1040.11.

8.3 μm single-mode pigtail or connector

Wavelength = 1.3 μm

Maximum power = 10 mW

Because of size constraints, laser safety labeling is not affixed to the module but attached to the outside of the shipping carton.

Product is not shipped with power supply.

Caution: Use of controls, adjustments, and procedures other than those specified herein may result in hazardous laser radiation exposure.

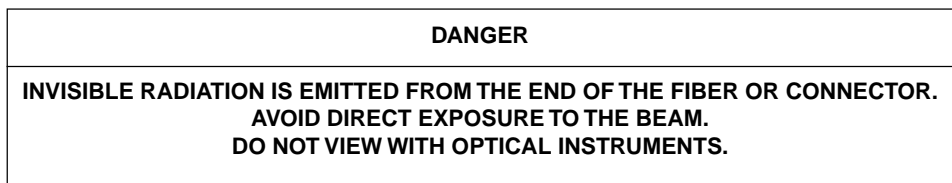
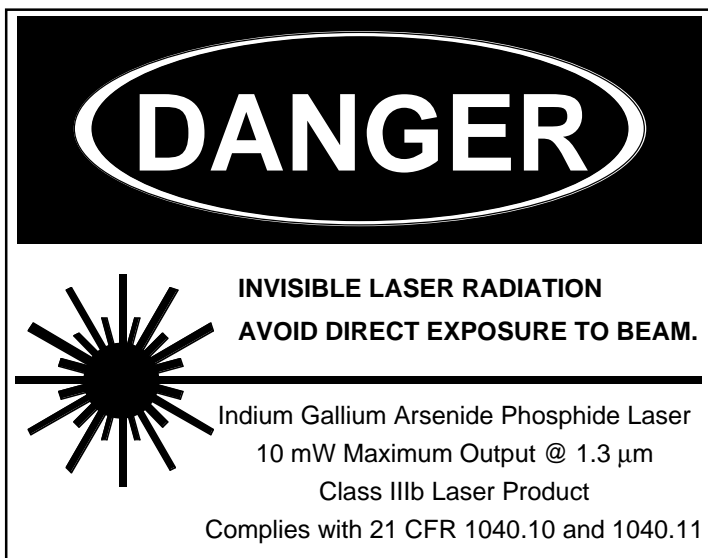

Ordering Information

Table 4. Ordering Information

Device Code*	Comcode	Pfiber	Connector
D372-20AS	108088048	2.0 mW	SC-PC
D372-20BS	108224973	2.0 mW	SC-APC
D372-20FS	108130469	2.0 mW	FC-PC
D372-20GS	108332032	2.0 mW	FC-APC

* Trailing S in code indicates that module contains an isolator.

For additional information, contact your Microelectronics Group Account Manager or the following:

INTERNET: <http://www.lucent.com/micro>, or for Optoelectronics information, <http://www.lucent.com/micro/opto>

E-MAIL: docmaster@micro.lucent.com

N. AMERICA: Microelectronics Group, Lucent Technologies Inc., 555 Union Boulevard, Room 30L-15P-BA, Allentown, PA 18103
1-800-372-2447, FAX 610-712-4106 (In CANADA: **1-800-553-2448**, FAX 610-712-4106)

ASIA PACIFIC: Microelectronics Group, Lucent Technologies Singapore Pte. Ltd., 77 Science Park Drive, #03-18 Cintech III, Singapore 118256
Tel. (65) 778 8833, FAX (65) 777 7495

CHINA: Microelectronics Group, Lucent Technologies (China) Co., Ltd., A-F2, 23/F, Zao Fong Universe Building, 1800 Zhong Shan Xi Road, Shanghai 200233 P. R. China **Tel. (86) 21 6440 0468, ext. 316**, FAX (86) 21 6440 0652

JAPAN: Microelectronics Group, Lucent Technologies Japan Ltd., 7-18, Higashi-Gotanda 2-chome, Shinagawa-ku, Tokyo 141, Japan
Tel. (81) 3 5421 1600, FAX (81) 3 5421 1700

EUROPE: Data Requests: MICROELECTRONICS GROUP DATALINE: **Tel. (44) 1189 324 299**, FAX (44) 1189 328 148
Technical Inquiries: OPTOELECTRONICS MARKETING: **(44) 1344 865 900** (Ascot UK)

Lucent Technologies Inc. reserves the right to make changes to the product(s) or information contained herein without notice. No liability is assumed as a result of their use or application. No rights under any patent accompany the sale of any such product(s) or information. *FastLight* is a trademark of Lucent Technologies Inc.

Copyright © 1999 Lucent Technologies Inc.
All Rights Reserved

January 1999
DS99-023LWP (Replaces DS98-350LWP)

microelectronics group

Lucent Technologies
Bell Labs Innovations

