

# MI204

## PIN DIODE

### DESCRIPTION

The MI204 PIN diode is employing a high reliability glass construction designed for RF small signal attenuator in VHF UHF.

### FEATURES

- Long carrier lifetime
- Low distortion
- Large dynamic range

### APPLICATION

RF attenuator RF switching

### OUTLINE DRAWING

Dimension: mm

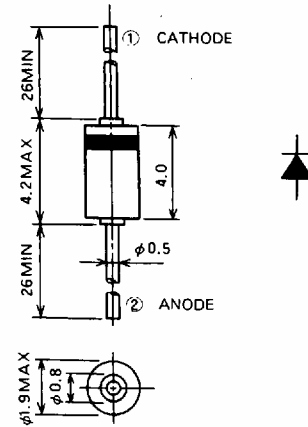

### ABSOLUTE MAXIMUM RATINGS ( $T_a = 25^\circ\text{C}$ )

Symbol	Parameter	Rating	Unit
$V_{RM}$	Repetitive peak reverse voltage	30	V
$V_R$	Reverse voltage	28	V
P	Power dissipation	200	mW
$T_j$	Junction temperature	175	$^\circ\text{C}$
$T_{stg}$	Storage temperature	-55 to 175	$^\circ\text{C}$

### ELECTRICAL CHARACTERISTICS ( $T_a = 25^\circ\text{C}$ )

Symbol	Parameter	Test conditions	Limits			Unit
			Min	Typ	Max	
$I_{R1}$	Reverse current	$V_R = 30\text{V}$			10	$\mu\text{A}$
$I_{R2}$	Reverse current	$V_R = 28\text{V}$			0.5	$\mu\text{A}$
$V_F$	Forward voltage	$I_F = 100\text{mA}$			1.0	V
$r_{fs1}$	Forward series resistance	$I_F = 10\text{mA}, f = 50\text{MHz}$		5.5	10	$\Omega$
$r_{fs2}$		$I_F = 10\mu\text{A}, f = 50\text{MHz}$	1.0	1.5		k $\Omega$
$C_t$	Diode capacitance	$V_R = 15\text{V}, f = 1.0\text{MHz}$		0.7	1.2	pF
$\tau$	Life time	$I_F = 10\text{mA}$		2.1		$\mu\text{s}$
$*t_s$	Storage time	$I_F = 10\text{mA}, I_R = 10\text{mA}$	0.6	1.5		$\mu\text{s}$

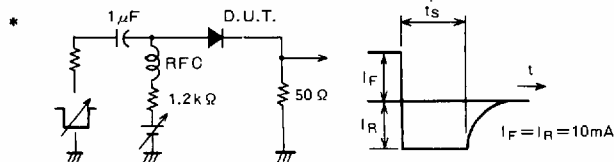

TYPICAL PERFORMANCE DATA

FORWARD SERIES RESISTANCE VS. FORWARD CURRENT CHARACTERISTICS

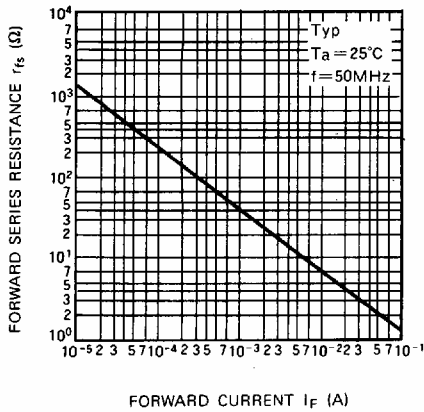

TOTAL CAPACITANCE VS. REVERSE VOLTAGE CHARACTERISTICS

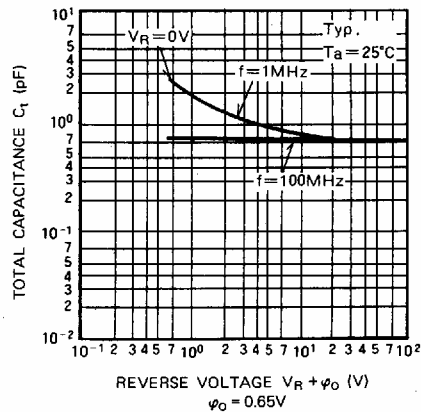

FORWARD CURRENT VS. FORWARD VOLTAGE CHARACTERISTICS

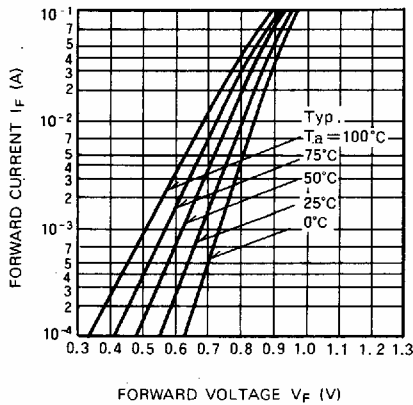

REVERSE CURRENT VS. REVERSE VOLTAGE CHARACTERISTICS

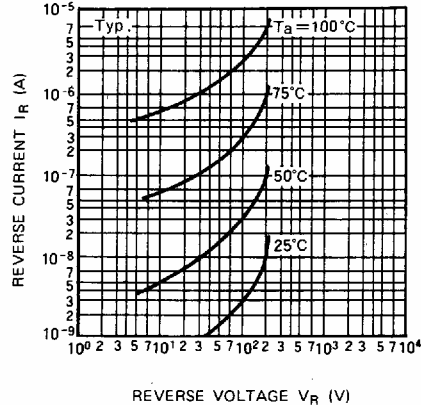

PARALLEL RESISTANCE VS. REVERSE VOLTAGE CHARACTERISTICS

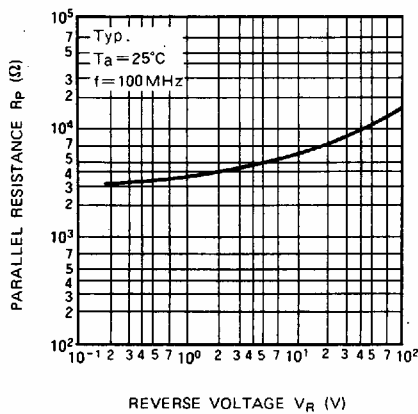

INTER MODULATION DISTORTION

