

T-1^{3/4} (5 mm), T-1 (3 mm), Ultra-Bright LED Lamps

Technical Data

HLMP-3750, -3850, -3950
HLMP-3390, -3490, -3590
HLMP-1340, -1440, -1540
HLMP-D640
HLMP-K640

Features

- Improved Brightness
- Improved Color Performance
- Available in Popular T-1 and T-1^{3/4} Packages
- New Sturdy Leads
- IC Compatible/Low Current Capability
- Reliable and Rugged
- Choice of 3 Bright Colors
High Efficiency Red
High Brightness Yellow
High Performance Green

Applications

- Lighted Switches
- Backlighting Front Panels
- Light Pipe Sources
- Keyboard Indicators

Description

These clear, non-diffused lamps out-perform conventional LED lamps. By utilizing new higher intensity material, we achieve superior product performance.

The HLMP-3750/-3390/-1340 Series Lamps are Gallium Arsenide Phosphide on Gallium Phosphide red light emitting diodes. The HLMP-3850/



-3490/-1440 Series are Gallium Arsenide Phosphide on Gallium Phosphide yellow light emitting diodes. The HLMP-3950/-3590/-1540/-D640/-K640 Series Lamps are Gallium Phosphide green light emitting diodes.

Axial Luminous Intensity and Viewing Angle @ 25°C

Part Number HLMP-	Package Description	Color	I _v (mcd) @ 20 mA DC		2θ ^{1/2} [1]	Package Outline
			Min.	Typ.		
3750	T-1 ^{3/4}	HER	90	125	24°	A
3850		Yellow	96	140	24°	A
3950		Green	111	265	24°	A
D640 ^[2]		Emerald Green	6.7	21	24°	D
3390	T-1 ^{3/4} Low Profile	HER	35	55	32°	B
3490		Yellow	37	55	32°	B
3590		Green	40	55	32°	B
1340	T-1	HER	22	45	45°	C
1440		Yellow	23	45	45°	C
1540		Green	27	45	45°	C
K640 ^[2]		Emerald Green	4.2	21	45°	C

Note:

1. θ^{1/2} is the typical off-axis angle at which the luminous intensity is half the axial luminous intensity.
2. Please refer to Application Note 1061 for information comparing standard green and emerald green light output degradation.

Package Dimensions

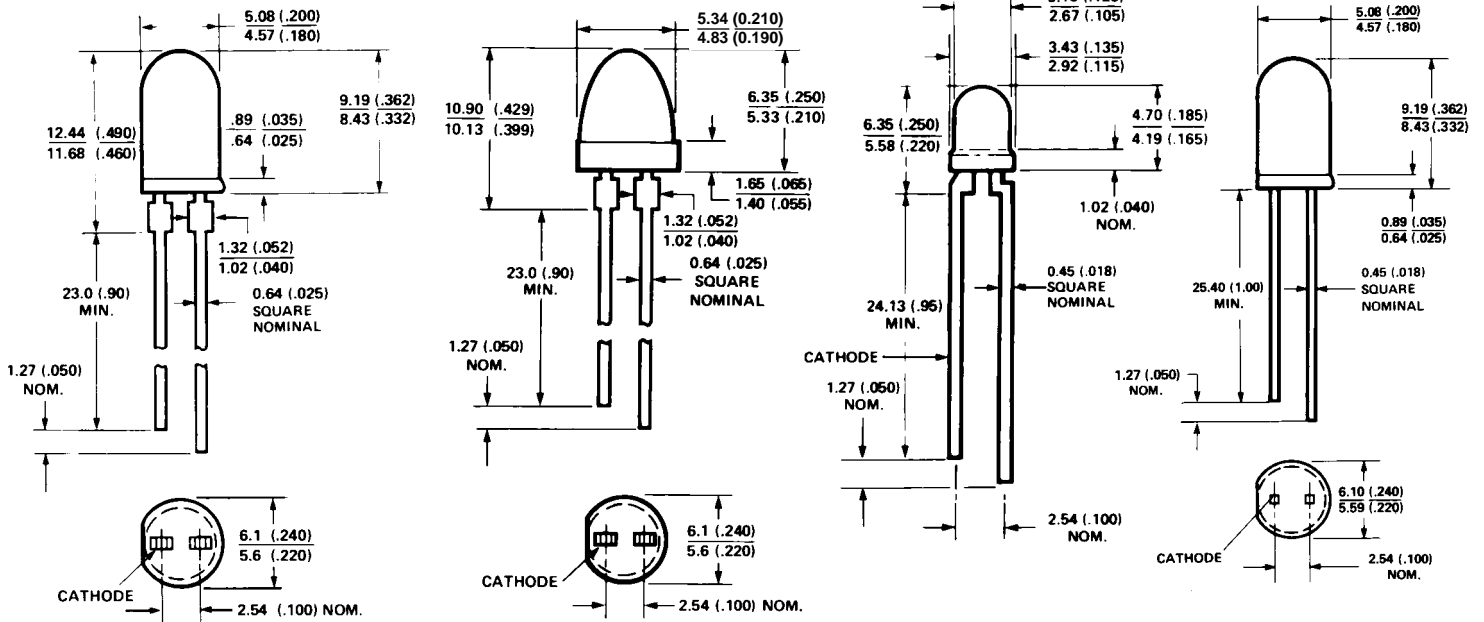

PACKAGE OUTLINE "A"
HLMP-3750, -3850, -3950

PACKAGE OUTLINE "B"
HLMP-3390, -3490, -3590

PACKAGE OUTLINE "C"
HLMP-1340, -1440, -1540, -K640

PACKAGE OUTLINE "D"
HLMP-D640

NOTES:

1. ALL DIMENSIONS ARE IN MILLIMETERS (INCHES).
2. AN EPOXY MENISCUS MAY EXTEND ABOUT 1 mm (0.40") DOWN THE LEADS.

Absolute Maximum Ratings at $T_A = 25^\circ\text{C}$

Parameter	Red	Yellow	Green/Emerald Green	Units
Peak Forward Current	90	60	90	mA
Average Forward Current ^[1]	25	20	25	mA
DC Current ^[2]	30	20	30	mA
Transient Forward Current ^[3] (10 μs Pulse)	500	500	500	mA
Reverse Voltage ($I_R = 100 \mu\text{A}$)	5	5	5	V
LED Junction Temperature	110	110	110	$^\circ\text{C}$
Operating Temperature Range	-55 to +100	-55 to +100	-20 to +100	$^\circ\text{C}$
Storage Temperature Range			-55 to +100	
Lead Soldering Temperature [1.6 mm (0.063 in.) from body]	260 $^\circ\text{C}$ for 5 seconds			

Notes:

1. See Figure 2 to establish pulsed operating conditions.
2. For Red and Green series derate linearly from 50 $^\circ\text{C}$ at 0.5 mA/ $^\circ\text{C}$. For Yellow series derate linearly from 50 $^\circ\text{C}$ at 0.2 mA/ $^\circ\text{C}$.
3. The transient peak current is the maximum non-recurring peak current the devices can withstand without damaging the LED die and wire bonds. It is not recommended that the device be operated at peak currents beyond the Absolute Maximum Peak Forward Current.

Electrical/Optical Characteristics at $T_A = 25^\circ\text{C}$

Symbol	Description	T-1 ^{3/4}	T-1 ^{3/4} Low Dome	T-1	Min.	Typ.	Max.	Units	Test Conditions
λ_{PEAK}	Peak Wavelength	3750 3850 3950 D640	3390 3490 3590	1340 1440 1540 K640		635 583 565 558		nm	Measurement at Peak
λ_d	Dominant Wavelength	3750 3850 3950 D640	3390 3490 3590	1340 1440 1540 K640		626 585 569 560		nm	Note 1
$\Delta\lambda^{1/2}$	Spectral Line Halfwidth	3750 3850 3950 D640	3390 3490 3590	1340 1440 1540 K640		40 36 28 24		nm	
τ_s	Speed of Response	3750 3850 3950 D640	3390 3490 3590	1340 1440 1540 K640		90 90 500 3100		ns	
C	Capacitance	3750 3850 3950 D640	3390 3490 3590	1340 1440 1540 K640		11 15 18 35		pF	$V_F = 0, f = 1 \text{ MHz}$
$R\theta_{\text{J-PIN}}$	Thermal Resistance	3750 3850 3950 D640	3390 3490 3590	1340 1440 1540 K640		210 210 210 510 290 290 290 290		$^\circ\text{C/W}$	Junction to Cathode Lead
V_F	Forward Voltage	3750 3850 3950 D640	3390 3490 3590	1340 1440 1540 K640	1.5 1.5 1.5	1.9 2.1 2.2 2.2	2.6 2.6 3.0 3.0	V	$I_F = 20 \text{ mA}$ (Figure 3)
V_R	Reverse Breakdown Voltage	3750 3850 3950 D640	3390 3490 3590	1340 1440 1540 K640	5.0			V	$I_F = 100 \mu\text{A}$
η_V	Luminous Efficacy	3750 3850 3950 D640	3390 3490 3590	1340 1440 1540 K640		145 500 595 655		$\frac{\text{lumens}}{\text{watt}}$	Note 2

Notes:

1. The dominant wavelength, λ_d , is derived from the CIE chromaticity diagram and represents the single wavelength which defines the color of the device.
2. The radiant intensity, I_e , in watts per steradian, may be found from the equation $I_e = I_v/\eta_V$, where I_v is the luminous intensity in candelas and η_V is the luminous efficacy in lumens/watt.

Red, Yellow, and Green

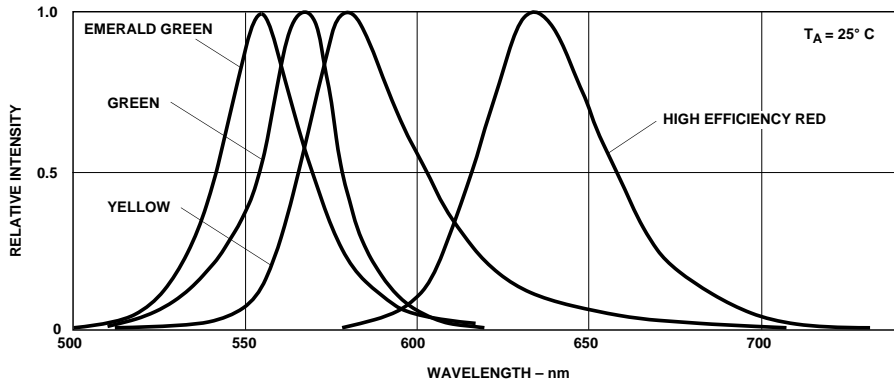

Figure 1. Relative Intensity vs. Wavelength.

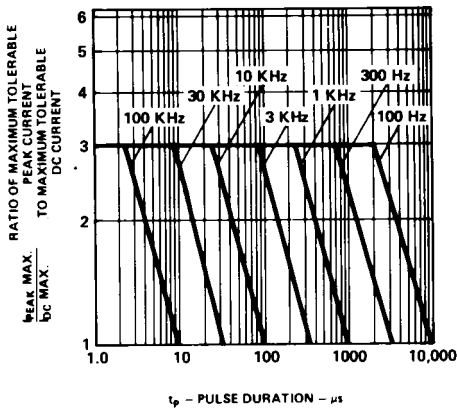

Figure 2. Maximum Tolerable Peak Current vs. Pulse Duration. (I_{DC} MAX as per MAX Ratings).

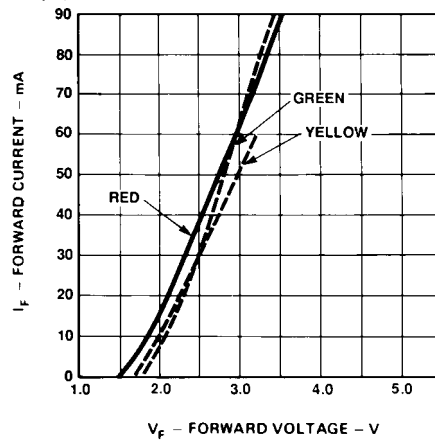

Figure 3. Forward Current vs. Forward Voltage.

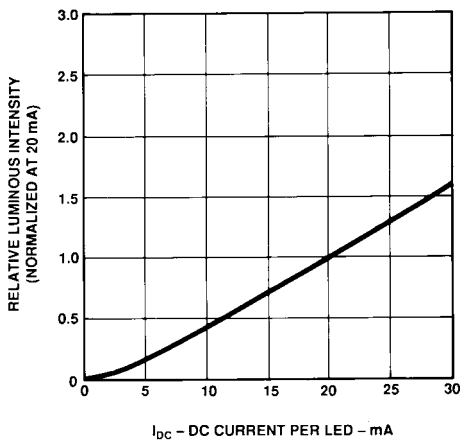

Figure 4. Relative Luminous Intensity vs. Forward Current.

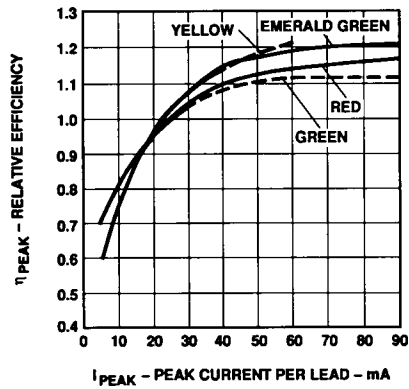

Figure 5. Relative Efficiency (Luminous Intensity per Unit Current) vs. Peak Current.

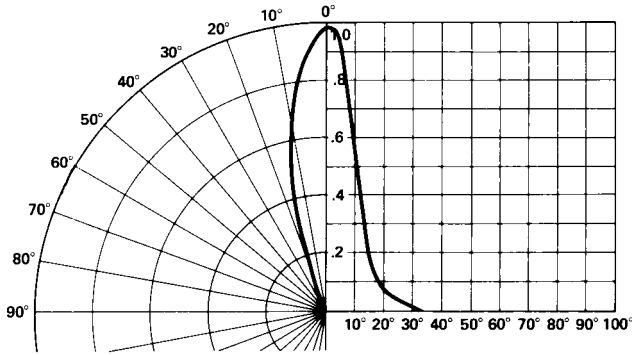

Figure 6. Relative Luminous Intensity vs. Angular Displacement. T-1^{3/4} Lamp.

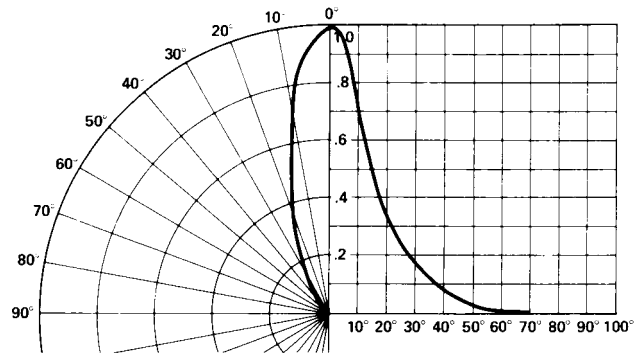

Figure 7. Relative Luminous Intensity vs. Angular Displacement. T-1^{3/4} Low Profile Lamp.

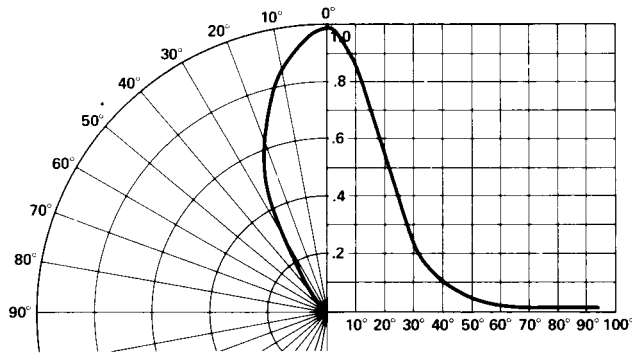
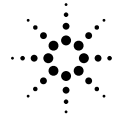

Figure 8. Relative Luminous Intensity vs. Angular Displacement. T-1 Lamp.



Agilent Technologies

Innovating the HP Way

www.semiconductor.agilent.com

Data subject to change.

Copyright © 1999 Agilent Technologies, Inc.

Obsoletes 5964-9290E

5968-3383E (11/99)