



MICROWAVE CORPORATION v01.0705



HMC332 / 332E

GaAs MMIC MIXER w/ INTEGRATED LO AMPLIFIER, 2.0 - 2.8 GHz

Typical Applications

The HMC332 / HMC332E is ideal for:

- MMDS
- PCMCIA
- WirelessLAN
- WCDMA micro-BTS

Features

- Integrated LO Amplifier w/ P_{diss}: < 20 mW
- Conversion Loss / Noise Figure: 8.0 dB
- Low LO Drive Level: 0 dBm
- Input IP3: +10 dBm
- Single Positive Supply: 3V to 5V

Functional Diagram

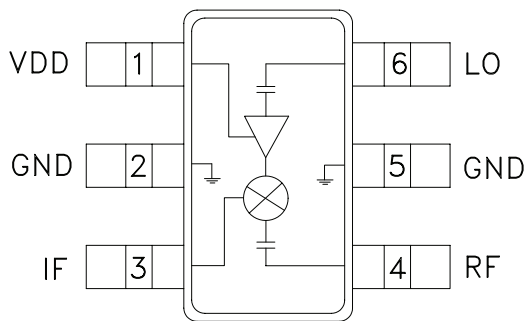

General Description

The HMC332 & HMC332E are single balanced mixer ICs with integrated LO amplifiers. This converter IC can operate as an upconverter or downconverter between 2.0 GHz and 2.8 GHz. With the integrated LO amplifier, the mixer requires an LO drive level of only 0 dBm, and requires only 6 mA from a single positive +3V rail. The mixer has 8 dB of conversion loss, an input P1dB of 0 dBm, and an input third order intercept point of +10 dBm.

Electrical Specifications, T_a = +25° C

Parameter	IF = 100 MHz LO = 0 dBm & V _{dd} = +3V			Units
	Min.	Typ.	Max.	
Frequency Range, RF & LO	2.0 - 2.8			GHz
Frequency Range, IF	DC - 1.0			GHz
Conversion Loss		8	10	dB
Noise Figure (SSB)		8	10	dB
LO to RF Isolation	11	20		dB
LO to IF Isolation	2	5		dB
RF to IF Isolation	11	17		dB
IP3 (Input)	4	10		dBm
1 dB Compression (Input)	-4	0		dBm
Supply Current (I _{dd})		6		mA

* Unless otherwise noted, all measurements performed as downconverter, IF= 100 MHz.

For price, delivery, and to place orders, please contact Hittite Microwave Corporation:
 20 Alpha Road, Chelmsford, MA 01824 Phone: 978-250-3343 Fax: 978-250-3373
 Order On-line at www.hittite.com

Conversion Gain vs. Temperature @ LO = 0 dBm

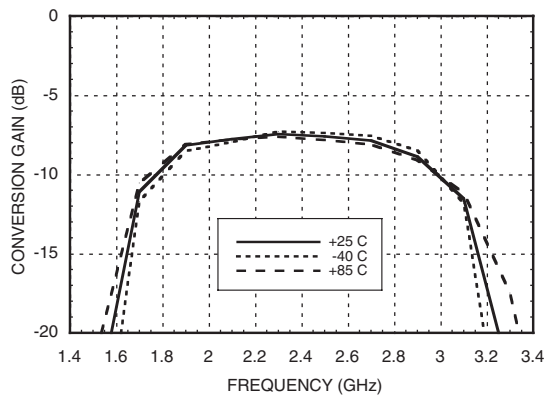

Isolation @ LO = 0 dBm

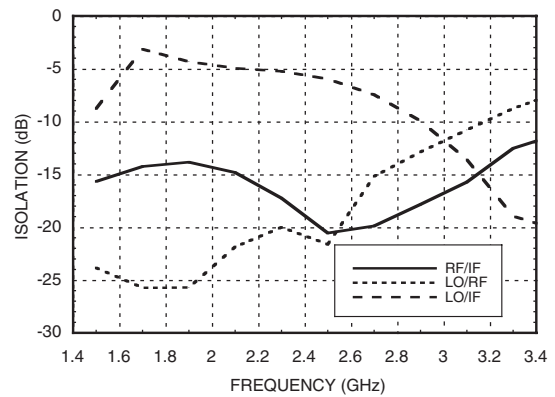

Conversion Gain vs. LO Drive

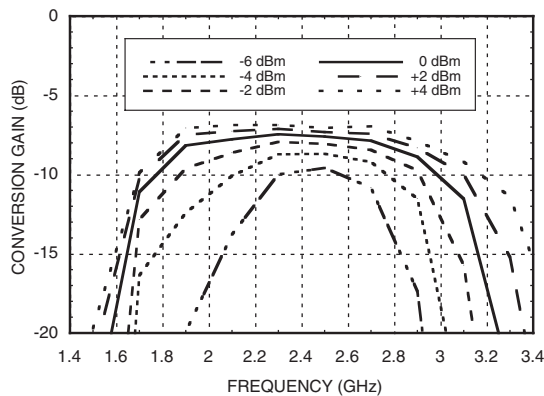

Return Loss @ LO = 0 dBm

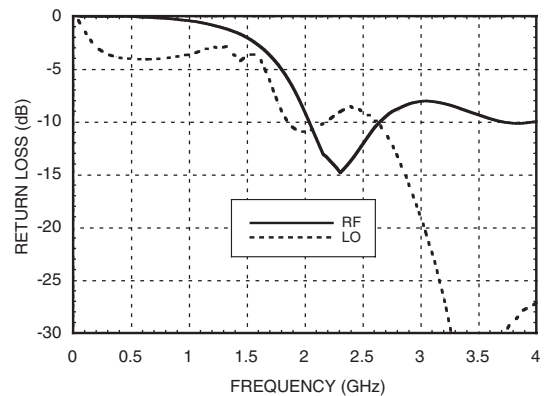

Conversion Gain vs. Vdd @ LO = 0 dBm

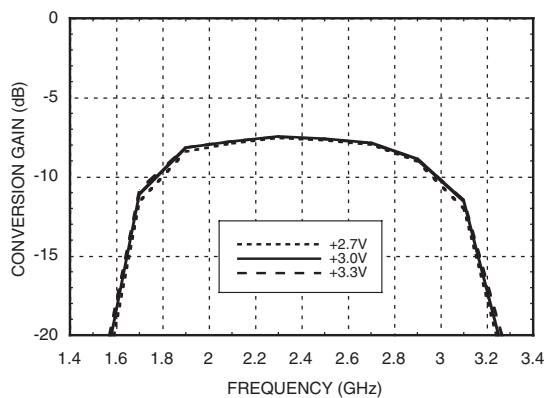

IF Bandwidth @ LO = 0 dBm

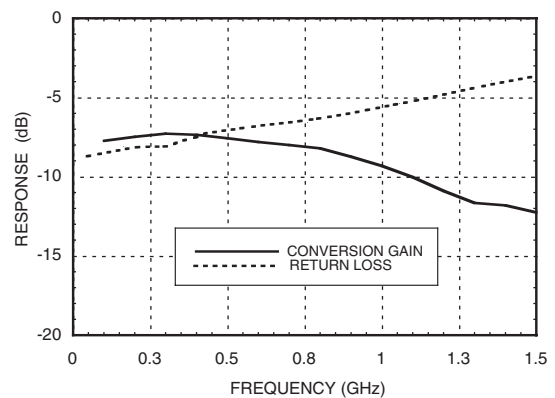



v01.0705



HMC332 / 332E

GaAs MMIC MIXER w/ INTEGRATED LO AMPLIFIER, 2.0 - 2.8 GHz

**Upconverter Performance
Conversion Gain @ LO = 0 dBm**

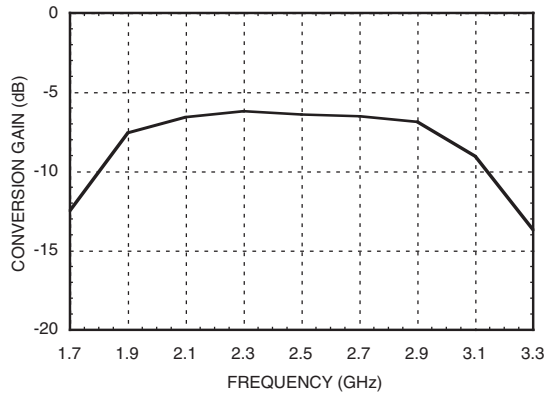

**Input P1dB vs.
Temperature @ LO = 0 dBm**

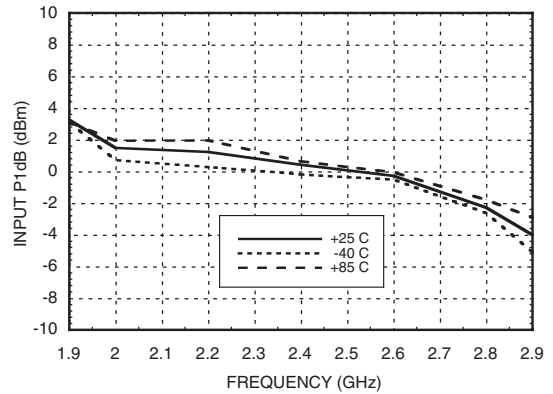

Input IP3 vs. LO Drive*

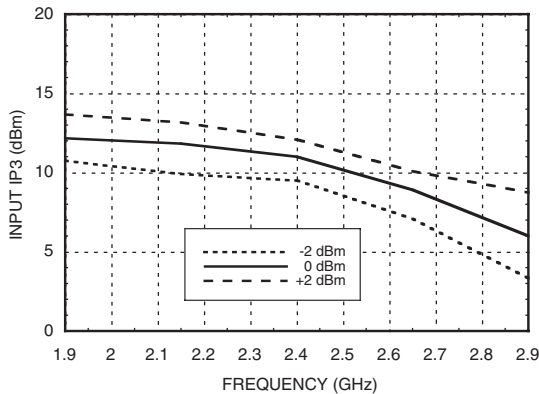

**Input IP3 vs.
Temperature @ LO = 0 dBm***

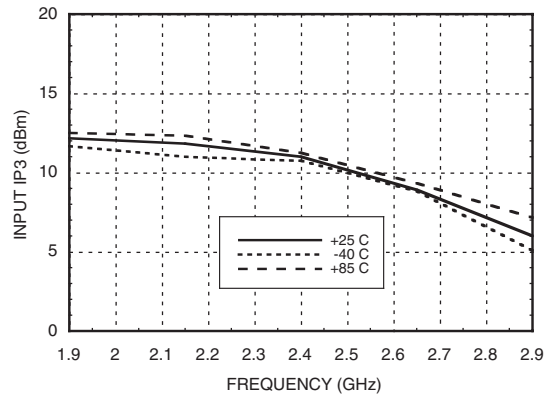

Input IP3 vs. Vdd @ LO = 0 dBm*

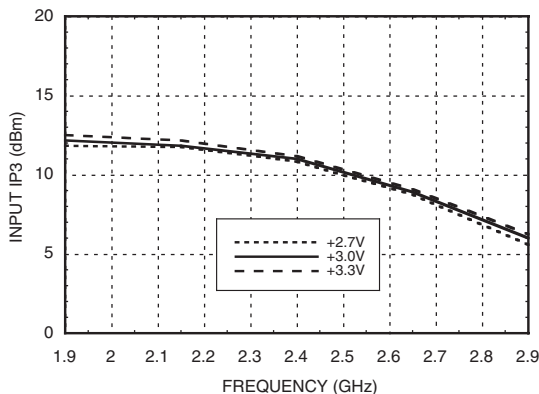

Input P1dB vs. Vdd @ LO = 0 dBm

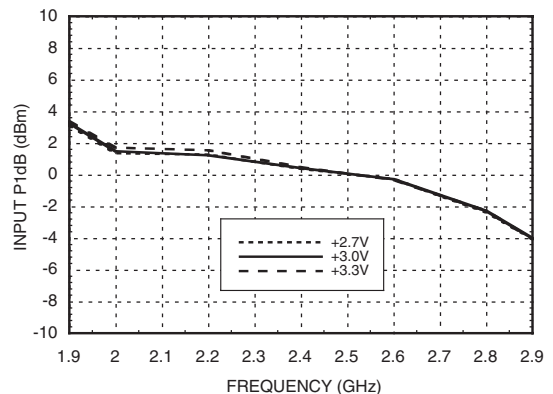

* Two-tone input power = -10 dBm each tone, 1 MHz spacing.



MICROWAVE CORPORATION v01.0705



HMC332 / 332E

GaAs MMIC MIXER w/ INTEGRATED LO AMPLIFIER, 2.0 - 2.8 GHz

MxN Spurious @ IF Port

mRF	nLO				
	0	1	2	3	4
0	xx	-11	8	8	43
1	12	0	31	34	48
2	41	35	39	32	45
3	>74	64	>74	50	67
4	>74	>74	>74	71	67

RF = 2.5 GHz @ -10 dBm
 LO = 2.4 GHz @ 0 dBm
 All values in dBc below IF power level.

Harmonics of LO

LO Freq. (GHz)	nLO Spur @ RF Port			
	1	2	3	4
2	24	6	19	32
2.2	20	7	18	44
2.4	20	9	22	43
2.6	19	13	18	40
2.8	14	18	21	38
3	11	15	24	39

LO = 0 dBm
 All values in dBc below input LO level @ RF port.

Absolute Maximum Ratings

RF / IF Input (Vdd = +3V)	+13 dBm
LO Drive (Vdd = +3V)	+13 dBm
Vdd	5.5V
Continuous P _{diss} (T _a = 85 °C) (derate 2.64 mW/°C above 85 °C)	238 mW
IF DC Current	±3 mA
Storage Temperature	-65 to +150 °C
Operating Temperature	-40 to +85 °C



ELECTROSTATIC SENSITIVE DEVICE
OBSERVE HANDLING PRECAUTIONS

Outline Drawing

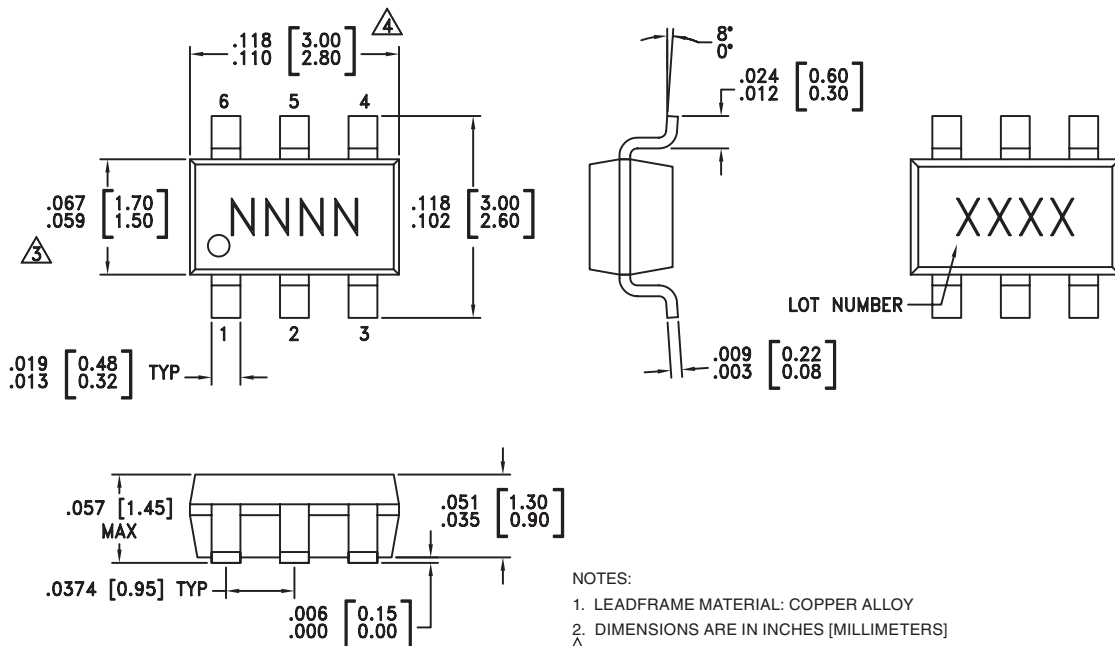

- NOTES:
- LEADFRAME MATERIAL: COPPER ALLOY
 - DIMENSIONS ARE IN INCHES [MILLIMETERS]
 - DIMENSION DOES NOT INCLUDE MOLDFLASH OF 0.15mm PER SIDE.
 - DIMENSION DOES NOT INCLUDE MOLDFLASH OF 0.25mm PER SIDE.
 - ALL GROUND LEADS MUST BE SOLDERED TO PCB RF GROUND.

Package Information

Part Number	Package Body Material	Lead Finish	MSL Rating	Package Marking ^[3]
HMC332	Low Stress Injection Molded Plastic	Sn/Pb Solder	MSL1 ^[1]	H332 XXXX
HMC332E	RoHS-compliant Low Stress Injection Molded Plastic	100% matte Sn	MSL1 ^[2]	332E XXXX

[1] Max peak reflow temperature of 235 °C

[2] Max peak reflow temperature of 260 °C

[3] 4-Digit lot number XXXX

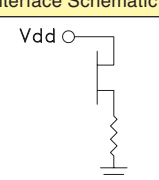
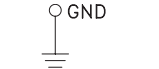
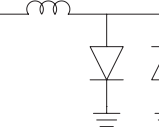
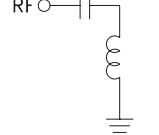
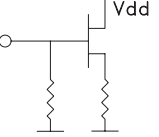

Pin Descriptions

Pin Number	Function	Description	Interface Schematic
1	Vdd	Power supply for the LO Amplifier. Two external RF bypass capacitors (10 pF & 10,000 pF) and an external inductor (4.7 nH) are required.	
2, 5	GND	Ground: Pin must connect to RF ground.	
3	IF	This pin is DC coupled. For applications not requiring operation to DC, this port should be DC blocked externally using a series capacitor whose value have been chosen to pass the necessary IF frequency range. For operation to DC, this pin must not source/sink more than 3mA of current or die non-function and possible die failure will result.	
4	RF	This pin is AC coupled and matched to 50 Ohm from 2.0 - 2.8 GHz.	
6	LO	This pin is AC coupled and matched to 50 Ohm from 2.0 - 2.8 GHz.	

Application Circuit

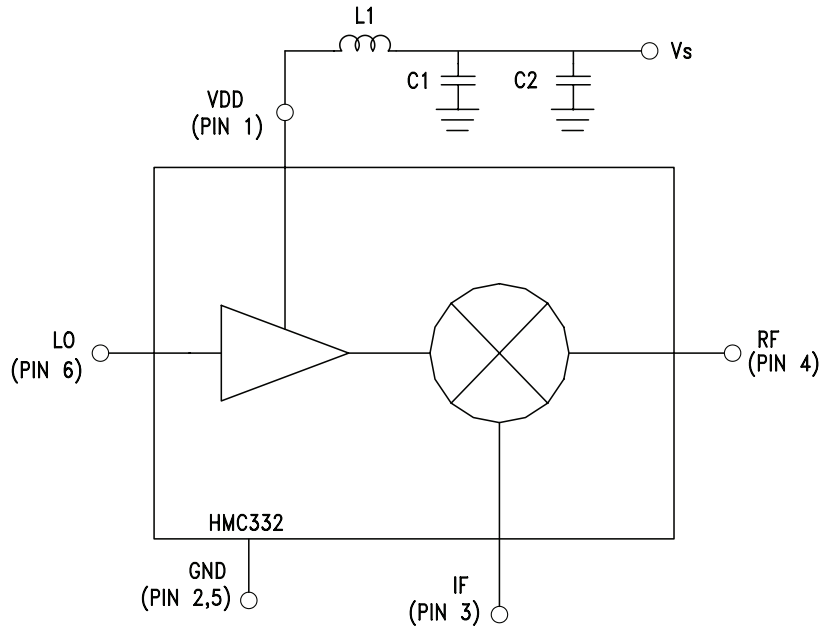

Evaluation PCB

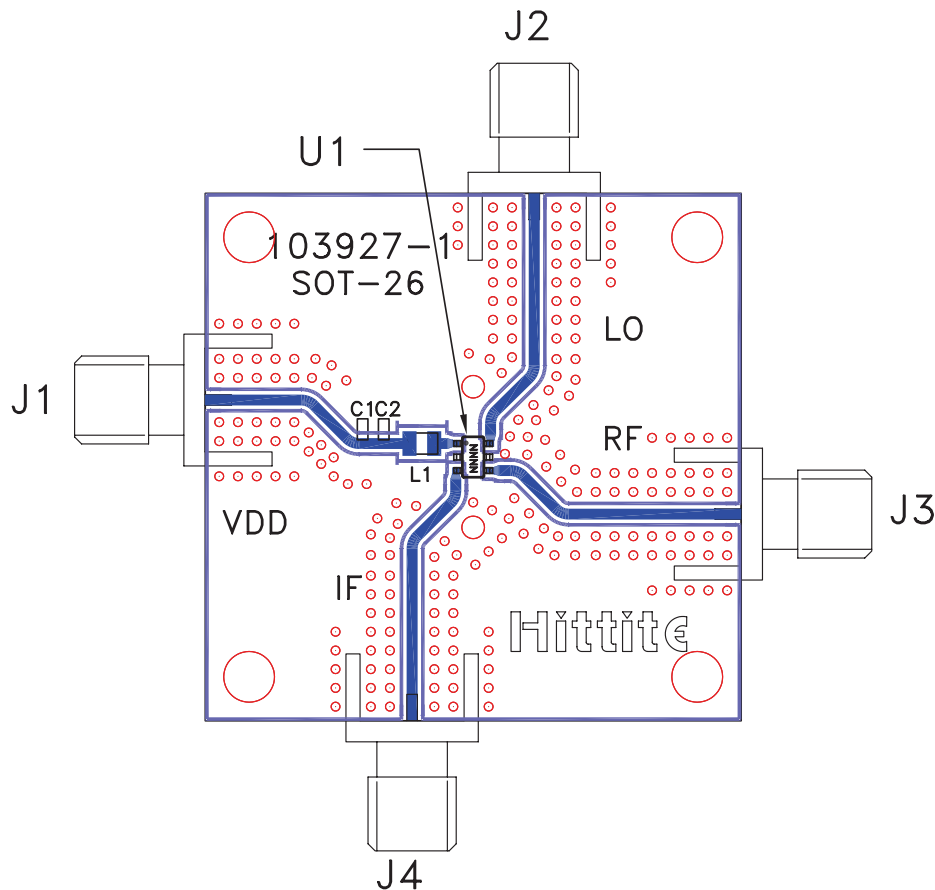

List of Materials for Evaluation PCB 105099 [1]

Item	Description
J1 - J4	PCB Mount SMA RF Connector
C1	10 pF Capacitor, 0603 Pkg.
C2	.01 μ F Capacitor, 0603 Pkg.
L1	4.7 nH Inductor, 0805 Pkg.
U1	HMC332 / HMC332E Mixer
PCB [2]	103927 Evaluation Board

[1] Reference this number when ordering complete evaluation PCB

[2] Circuit Board Material: Rogers 4350

The circuit board used in the final application should use RF circuit design techniques. Signal lines should have 50 ohm impedance while the package ground leads should be connected directly to the ground plane similar to that shown. A sufficient number of VIA holes should be used to connect the top and bottom ground planes. The evaluation circuit board shown is available from Hittite upon request.