

AVX Multilayer Ceramic Transient Voltage Suppressors

GENERAL DESCRIPTION

The AVX TransGuard® Transient Voltage Suppressors (TVS) with unique high-energy multilayer construction represents state-of-the-art overvoltage circuit protection. Monolithic multilayer construction provides protection from voltage transients caused by ESD, lightning, NEMP, inductive switching, etc. True surface mount product is provided in EIA industry standard packages. Thru-hole components are supplied as conformally coated axial devices.

TRANSQUARD® DESCRIPTION

TransGuard® products are zinc oxide (ZnO) based ceramic semiconductor devices with non-linear voltage-current characteristics (bi-directional) similar to back-to-back zener diodes. They have the added advantage of greater current and energy handling capabilities as well as EMI/RFI attenuation. Devices are fabricated by a ceramic sintering process that yields a structure of conductive ZnO grains surrounded by electrically insulating barriers, creating varistor-like behavior.

The number of grain-boundary interfaces between conducting electrodes determines "Breakdown Voltage" of the device. High voltage applications such as AC line protection require many grains between electrodes while low voltage requires few grains to establish the appropriate breakdown voltage. Single layer ceramic disc processing proved to be a viable production method for thick cross section devices with many grains, but attempts to address low voltage suppression needs by processing single layer ceramic disc formulations with huge grain sites has had limited success.

AVX, the world leader in the manufacture of multilayer ceramic capacitors, now offers the low voltage transient protection marketplace a true multilayer, monolithic surface mount varistor. Technology leadership in processing thin dielectric materials and patented processes for precise ceramic grain growth have yielded superior energy dissipation in the smallest size. Now a varistor has voltage characteristics determined by design and not just cell sorting whatever falls out of the process.

Multilayer ceramic varistors are manufactured by mixing ceramic powder in an organic binder (slurry) and casting it into thin layers of precision thickness. Metal electrodes are deposited onto the green ceramic layers which are then stacked to form a laminated structure. The metal electrodes are arranged so that their terminations alternate from one end of the varistor to the other. The device becomes a monolithic block during the sintering (firing) cycle providing uniform energy dissipation in a small volume.

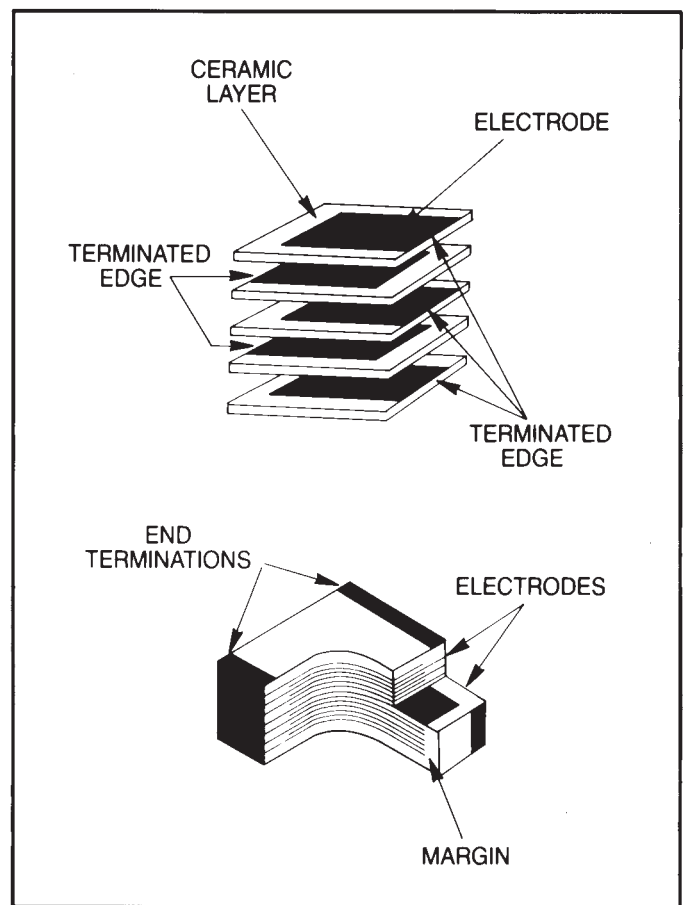
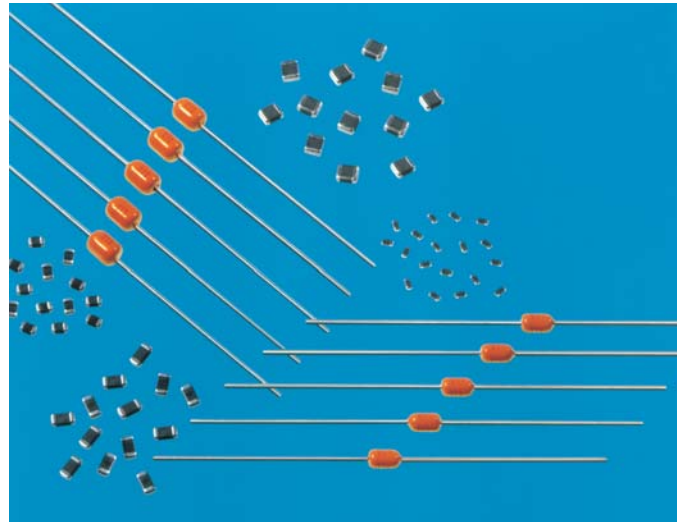

AVX Multilayer Ceramic Transient Voltage Suppressors

PART NUMBER IDENTIFICATION

Surface Mount Devices

Important: For part number identification only, not for construction of part numbers.

The information below only defines the numerical value of part number digits, and cannot be used to construct a desired set of electrical limits. Please refer to the TransGuard® part number data for the correct electrical ratings.

VC 1206 05 D 150 R P

TERMINATION FINISH:

P = Ni/Sn Alloy (Plated)
M = Ni/Sn Pb (Plated)

PACKAGING (Pcs/Reel):

STYLE	"D"	"R"	"T"	"W"
VC0402	N/A	N/A	N/A	10,000
VC0603	1,000	4,000	10,000	N/A
VC0805	1,000	4,000	10,000	N/A
VC1206	1,000	4,000	10,000	N/A
VC1210	1,000	2,000	10,000	N/A

CLAMPING VOLTAGE:

Where:	100 = 12V	500 = 50V
	150 = 18V	560 = 60V
	200 = 22V	580 = 60V
	250 = 27V	620 = 67V
	300 = 32V	650 = 67V
	390 = 42V	101 = 100V
	400 = 42V	121 = 120V

ENERGY:

Where:	A = 0.1J	J = 1.5J	S = 1.9-2.0J
	B = 0.2J <td>K = 0.6J <td>T = 0.01J</td> </td>	K = 0.6J <td>T = 0.01J</td>	T = 0.01J
	C = 0.3J <td>L = 0.8J <td>U = 4.0-5.0J</td> </td>	L = 0.8J <td>U = 4.0-5.0J</td>	U = 4.0-5.0J
	D = 0.4J <td>M = 1.0J <td>V = 0.02J</td> </td>	M = 1.0J <td>V = 0.02J</td>	V = 0.02J
	E = 0.5J <td>N = 1.1J <td>W = 6.0J</td> </td>	N = 1.1J <td>W = 6.0J</td>	W = 6.0J
	F = 0.7J <td>P = 3.0J <td>X = 0.05J</td> </td>	P = 3.0J <td>X = 0.05J</td>	X = 0.05J
	G = 0.9J <td>Q = 1.3J <td>Y = 12.0J</td> </td>	Q = 1.3J <td>Y = 12.0J</td>	Y = 12.0J
	H = 1.2J <td>R = 1.7J <td>Z = 25.0J</td> </td>	R = 1.7J <td>Z = 25.0J</td>	Z = 25.0J

WORKING VOLTAGE:

Where:	03 = 3.3 VDC	18 = 18.0 VDC
	05 = 5.6 VDC	26 = 26.0 VDC
	09 = 9.0 VDC	30 = 30.0 VDC
	12 = 12.0 VDC	48 = 48.0 VDC
	14 = 14.0 VDC	60 = 60.0 VDC

CASE SIZE DESIGNATOR:

SIZE	LENGTH	WIDTH
0402	1.00±0.10mm (0.040"±0.004")	0.5±0.10mm (0.020"±0.004")
0603	1.60±0.15mm (0.063"±0.006")	0.8±0.15mm (0.032"±0.006")
0805	2.01±0.2mm (0.079"±0.008")	1.25±0.2mm (0.049"±0.008")
1206	3.20±0.2mm (0.126"±0.008")	1.60±0.2mm (0.063"±0.008")
1210	3.20±0.2mm (0.126"±0.008")	2.49±0.2mm (0.098"±0.008")

CASE STYLE:

C = Chip

PRODUCT DESIGNATOR:

V = Varistor

MARKING:

All standard surface mount TransGuard® chips will **not** be marked.

Axial Leaded Devices

Important: For part number identification only, not for construction of part numbers.

The information below only defines the numerical value of part number digits, and cannot be used to construct a desired set of electrical limits. Please refer to the TransGuard® part number data for the correct electrical ratings.

V A 1000 05 D 150 R L

LEAD FINISH:

Copper clad steel, solder coated

PACKAGING (Pcs/Reel):

STYLE	"D"	"R"	"T"
VA1000	1,000	3,000	7,500
VA2000	1,000	2,500	5,000

CLAMPING VOLTAGE:

Where:	100 = 12V	580 = 60V
	150 = 18V	650 = 67V
	300 = 32V	101 = 100V
	400 = 42V	121 = 120V

ENERGY:

Where:	A = 0.1J
	D = 0.4J
	K = 2.0J

WORKING VOLTAGE:

Where:	03 = 3.3 VDC	26 = 26.0 VDC
	05 = 5.6 VDC	30 = 30.0 VDC
	14 = 14.0 VDC	48 = 48.0 VDC
	18 = 18.0 VDC	60 = 60.0 VDC

CASE SIZE DESIGNATOR:

SIZE	LENGTH	DIAMETER
1000	4.32mm (0.170")	2.54mm (0.100")
2000	4.83mm (0.190")	3.56mm (0.140")

CASE STYLE:

A = Axial

PRODUCT DESIGNATOR:

V = Varistor

MARKING:

All axial TransGuards® are marked with vendor identification, product identification, voltage/energy rating code and date code (see example below):

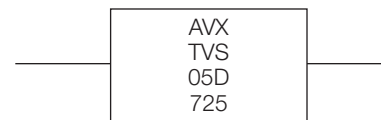

Where: AVX = Always AVX (Vendor Identification)
TVS = Always TVS (Product Identification - Transient Voltage Suppressor)
05D = Working VDC and Energy Rating (Joules)
Where: 05 = 5.6 VDC, D = 0.4J
725 = Three Digit Date Code
Where: 4 = Last digit of year (2007)
25 = Week of year

AVX Multilayer Ceramic Transient Voltage Suppressors

ELECTRICAL CHARACTERISTICS

AVX Part Number	Working Voltage (DC)	Working Voltage (AC)	Breakdown Voltage	Clamping Voltage	Test Current For V_c	Maximum Leakage Current	Transient Energy Rating	Peak Current Rating	Typical Cap	Frequency	Case Size
VC060303A100 __	3.3	2.3	5.0±20%	12	1	100	0.1	30	1450	K	0603
VC080503A100 __	3.3	2.3	5.0±20%	12	1	100	0.1	40	1400	K	0805
VC080503C100 __	3.3	2.3	5.0±20%	12	1	100	0.3	120	5000	K	0805
VC120603A100 __	3.3	2.3	5.0±20%	12	1	100	0.1	40	1250	K	1206
VC120603D100 __	3.3	2.3	5.0±20%	12	1	100	0.4	150	4700	K	1206
VA100003A100 __	3.3	2.3	5.0±20%	12	1	100	0.1	40	1500	K	1000
VA100003D100 __	3.3	2.3	5.0±20%	12	1	100	0.4	150	4700	K	1000
VC040205X150 __	5.6	4.0	8.5±20%	18	1	35	0.05	20	175	M	0402
VC060305A150 __	5.6	4.0	8.5±20%	18	1	35	0.1	30	750	K	0603
VC080505A150 __	5.6	4.0	8.5±20%	18	1	35	0.1	40	1100	K	0805
VC080505C150 __	5.6	4.0	8.5±20%	18	1	35	0.3	120	3000	K	0805
VC120605A150 __	5.6	4.0	8.5±20%	18	1	35	0.1	40	1200	K	1206
VC120605D150 __	5.6	4.0	8.5±20%	18	1	35	0.4	150	3000	K	1206
VA100005A150 __	5.6	4.0	8.5±20%	18	1	35	0.1	40	1000	K	1000
VA100005D150 __	5.6	4.0	8.5±20%	18	1	35	0.4	150	2800	K	1000
VC040209X200 __	9.0	6.4	12.7±15%	22	1	25	0.05	20	175	M	0402
VC060309A200 __	9.0	6.4	12.7±15%	22	1	25	0.1	30	550	K	0603
VC080509A200 __	9.0	6.4	12.7±15%	22	1	25	0.1	40	750	K	0805
VC080512A250 __	12.0	8.5	16±15%	27	1	25	0.1	40	525	K	0805
VC040214X300 __	14.0	10.0	18.5±12%	32	1	15	0.05	20	100	M	0402
VC060314A300 __	14.0	10.0	18.5±12%	32	1	15	0.1	30	350	K	0603
VC080514A300 __	14.0	10.0	18.5±12%	32	1	15	0.1	40	325	K	0805
VC080514C300 __	14.0	10.0	18.5±12%	32	1	15	0.3	120	900	K	0805
VC120614A300 __	14.0	10.0	18.5±12%	32	1	15	0.1	40	600	K	1206
VC120614D300 __	14.0	10.0	18.5±12%	32	1	15	0.4	150	1050	K	1206
VA100014A300 __	14.0	10.0	18.5±12%	32	1	15	0.1	40	325	K	1000
VA100014D300 __	14.0	10.0	18.5±12%	32	1	15	0.4	150	1100	K	1000
VC13MA0160KBA	16.0	14.0	24.5±10%	40	2.5	25	1.6	400	1800	K	1210
VC040218X400 __	18.0	13.0	25.5±10%	42	1	10	0.05	20	65	M	0402
VC060318A400 __	18.0	13.0	25.5±10%	42	1	10	0.1	30	150	K	0603
VC080518A400 __	18.0	13.0	25.5±10%	42	1	10	0.1	30	225	K	0805
VC080518C400 __	18.0	13.0	25.5±10%	42	1	10	0.3	100	550	K	0805
VC120618A400 __	18.0	13.0	25.5±10%	42	1	10	0.1	30	350	K	1206
VC120618D400 __	18.0	13.0	25.5±10%	42	1	10	0.4	150	900	K	1206
VC120618E380 __	18.0	13.0	22.0±10%	38	1	15	0.5	200	800	K	1206
VC121018J390 __	18.0	13.0	25.5±10%	42	5	10	1.5	500	3100	K	1210
VJ13MC0180KBA	18.0	13.0	24.0±10%	45	10	25	1.5	500	3000	K	1210
VA100018A400 __	18.0	13.0	25.5±10%	42	1	10	0.1	40	350	K	1000

└ Termination/Lead Finish Code
└ Packaging Code

AVX Multilayer Ceramic Transient Voltage Suppressors

ELECTRICAL CHARACTERISTICS

AVX Part Number	Working Voltage (DC)	Working Voltage (AC)	Breakdown Voltage	Clamping Voltage	Test Current For V_c	Maximum Leakage Current	Transient Energy Rating	Peak Current Rating	Typical Cap	Frequency	Case Size
VA100018D400 __	18.0	13.0	25.5±10%	42	1	10	0.4	150	900	K	1000
VC060326A580 __	26.0	18.0	34.5±10%	60	1	10	0.1	30	155	K	0603
VC080526A580 __	26.0	18.0	34.5±10%	60	1	10	0.1	30	120	K	0805
VC080526C580 __	26.0	18.0	34.5±10%	60	1	10	0.3	100	250	K	0805
VC120626D580 __	26.0	18.0	34.5±10%	60	1	10	0.4	120	500	K	1206
VC120626F540 __	26.0	20.0	33.0±10%	54	1	15	0.7	200	600	K	1206
VC121026H560 __	26.0	18.0	34.5±10%	60	5	10	1.2	300	2150	K	1210
VJ13MC0260KBA	26.0	18.0	33.0±10%	62	10	25	1.2	300	1120	K	1210
VC181226P540 __	26.0	20.0	33.0±10%	54	5	15	3.0	800	3000	K	1812
VA100026D580 __	26.0	18.0	34.5±10%	60	1	10	0.4	120	650	K	1000
VC060330A650 __	30.0	21.0	41.0±10%	67	1	10	0.1	30	125	K	0603
VC080530A650 __	30.0	21.0	41.0±10%	67	1	10	0.1	30	90	M	0805
VC120630D650 __	30.0	21.0	41.0±10%	67	1	10	0.4	120	400	K	1206
VC121030G620 __	30.0	21.0	41.0±10%	67	5	10	0.9	220	1750	K	1210
VC121030H620 __	30.0	21.0	41.0±10%	67	5	10	1.2	280	1850	K	1210
VJ13MC0300KBA	30.0	21.0	39.0±10%	73	10	25	0.9	220	1020	K	1210
VJ13PC0300KBA	30.0	21.0	39.0±10%	73	10	25	1.2	280	1150	K	1210
VA100030D650 __	30.0	21.0	41.0±10%	67	1	10	0.4	120	550	K	1000
VC120631M650 __	31.0	25.0	39.0±10%	65	1	15	1.0	200	500	K	1206
VC120638N770 __	38.0	30.0	47.0±10%	77	1	15	1.1	200	350	K	1206
VC121038S770 __	38.0	30.0	47.0±10%	77	2.5	15	2.0	300	750	K	1210
VC181238U770 __	38.0	30.0	47.0±10%	77	5	15	4.2	800	1700	K	1812
VC120645K900 __	45.0	35.0	56.0±10%	90	1	15	0.6	200	260	K	1206
VC181245U900 __	45.0	35.0	56.0±10%	90	5	15	4.0	500	1200	K	1812
VC120648D101 __	48.0	34.0	62.0±10%	100	1	10	0.4	100	225	K	1206
VC121048G101 __	48.0	34.0	62.0±10%	100	5	10	0.9	220	450	K	1210
VC121048H101 __	48.0	34.0	62.0±10%	100	5	10	1.2	250	500	K	1210
VJ13MC0480KBA	48.0	34.0	60.5±10%	110	10	25	0.9	220	800	K	1210
VJ13PC0480KBA	48.0	34.0	60.5±10%	110	10	25	1.2	250	840	K	1210
VA100048D101 __	48.0	34.0	62.0±10%	100	1	10	0.4	100	200	K	1000
VC120656F111 __	56.0	40.0	68.0±10%	110	1	15	0.7	100	180	K	1206
VC181256U111 __	56.0	40.0	68.0±10%	110	5	15	4.8	500	800	K	1812
VC121060J121 __	60.0	42.0	76.0±10%	120	5	10	1.5	250	400	K	1210
VJ13MC0600KBA	60.0	42.0	75.0±10%	126	10	25	1.5	250	600	K	1210
VA200060K121 __	60.0	42.0	76.0±10%	120	1	10	2.0	300	400	K	2000
VC120665L131 __	65.0	50.0	82.0±10%	135	1	15	0.8	100	120	K	1206

Termination/Lead Finish Code
Packaging Code

V_w (DC) DC Working Voltage (V)
 V_w (AC) AC Working Voltage (V)
 V_b Typical Breakdown Voltage (V @ 1mA_{DC})
 V_b Tol V_b Tolerance is ± from Typical Value
 V_c Clamping Voltage (V @ I_{c1})

I_{c1} Test Current for V_c (A, 8x20µS)
 I_l Maximum Leakage Current at the Working Voltage (µA)
 E_T Transient Energy Rating (J, 10x1000µS)
 I_p Peak Current Rating (A, 8x20µS)
Cap Typical Capacitance (pF) @ frequency specified and 0.5 V_{RMS}
Freq Frequency at which capacitance is measured (K = 1kHz, M = 1MHz)

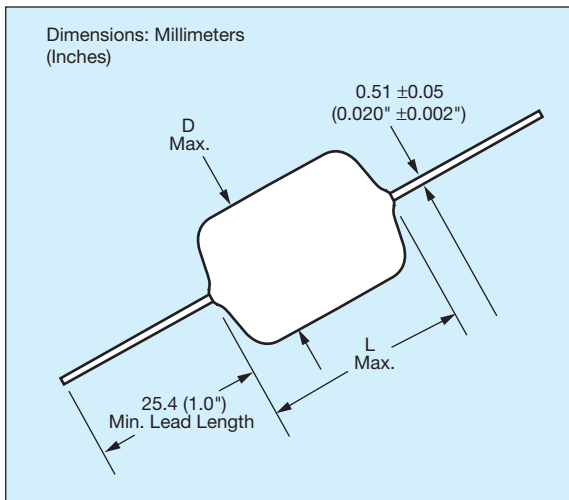

DIMENSIONS: mm (inches)

AVX Style		VA1000	VA2000
(L) Max Length	mm (in.)	4.32 (0.170)	4.83 (0.190)
(D) Max Diameter	mm (in.)	2.54 (0.100)	3.56 (0.140)

Lead Finish: Copper Clad Steel, Solder Coated

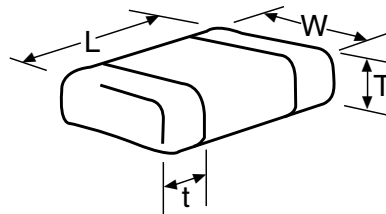

DIMENSIONS: mm (inches)

AVX Style		0402	0603	0805	1206	1210	1812	2220
(L) Length	mm (in.)	1.00±0.10 (0.040±0.004)	1.60±0.15 (0.063±0.006)	2.01±0.20 (0.079±0.008)	3.20±0.20 (0.126±0.008)	3.20±0.20 (0.126±0.008)	4.50±0.20 (0.177±0.008)	5.70±0.20 (0.224±0.008)
(W) Width	mm (in.)	0.50±0.10 (0.020±0.004)	0.80±0.15 (0.031±0.006)	1.25±0.20 (0.049±0.008)	1.60±0.20 (0.063±0.008)	2.49±0.20 (0.098±0.008)	3.20±0.20 (0.126±0.008)	5.00±0.20 (0.197±0.008)
(T) Max Thickness	mm (in.)	0.6 (0.024)	0.9 (0.035)	1.02 (0.040)	1.02 (0.040)	1.70 (0.067)	1.70 (0.067)	1.70 (0.067)
(t) Land Length	mm (in.)	0.25±0.15 (0.010±0.006)	0.35±0.15 (0.014±0.006)	0.71 max. (0.028 max.)	0.71 max. (0.028 max.)	0.71 max. (0.028 max.)	0.50±0.25 (0.020±0.010)	0.50±0.25 (0.020±0.010)

AVX Multilayer Ceramic Transient Voltage Suppressors

TYPICAL PERFORMANCE CURVES (0402 CHIP SIZE)

VOLTAGE/CURRENT CHARACTERISTICS

Multilayer construction and improved grain structure result in excellent transient clamping characteristics up to 20 amps peak current, while maintaining very low leakage currents under DC operating conditions. The VI curves below show the voltage/current characteristics for the 5.6V, 9V, 14V, 18V and low capacitance StaticGuard parts with currents ranging from parts of a micro amp to tens of amps.

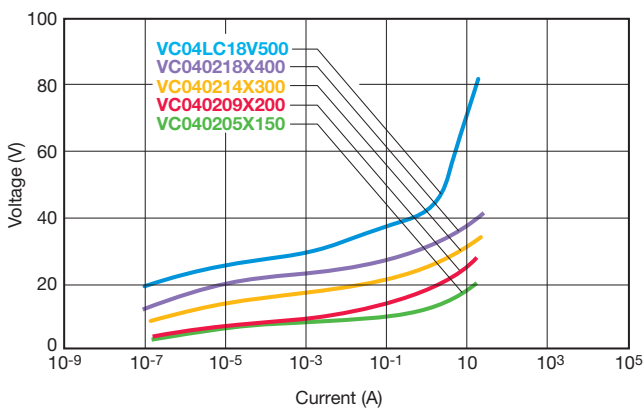

PULSE DEGRADATION

Traditionally varistors have suffered degradation of electrical performance with repeated high current pulses resulting in decreased breakdown voltage and increased leakage current. It has been suggested that irregular intergranular boundaries and bulk material result in restricted current paths and other non-Schottky barrier paralleled conduction paths in the ceramic. Repeated pulsing of TransGuard transient voltage suppressors with 150Amp peak 8 x 20µS waveforms shows negligible degradation in breakdown voltage and minimal increases in leakage current. This does not mean that TransGuard suppressors do not suffer degradation, but it occurs at much higher current.

ESD TEST OF 0402 PARTS

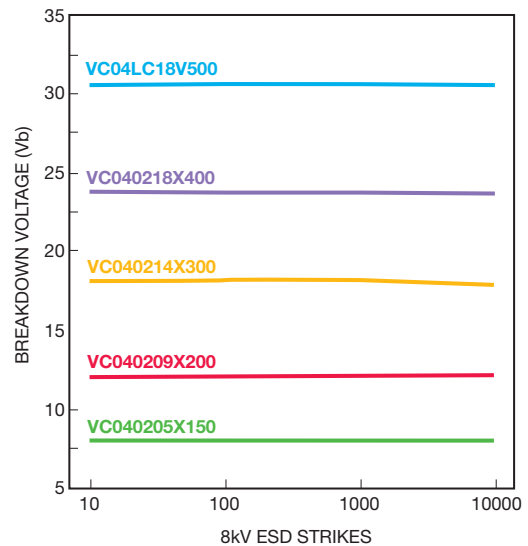

PEAK POWER VS PULSE DURATION

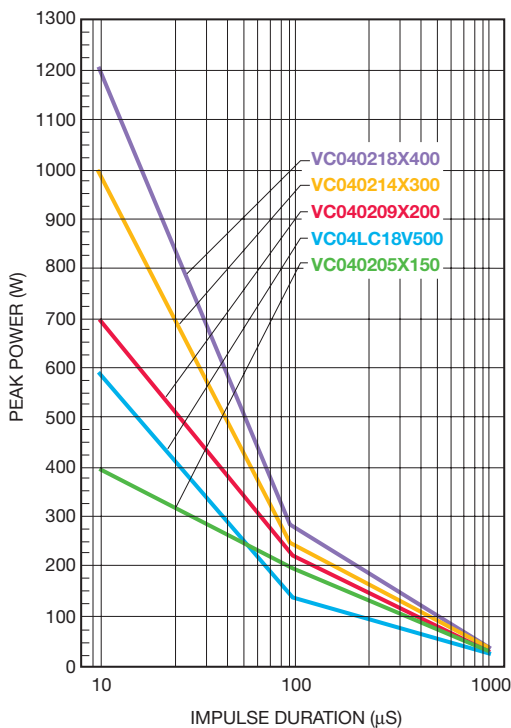

INSERTION LOSS CHARACTERISTICS

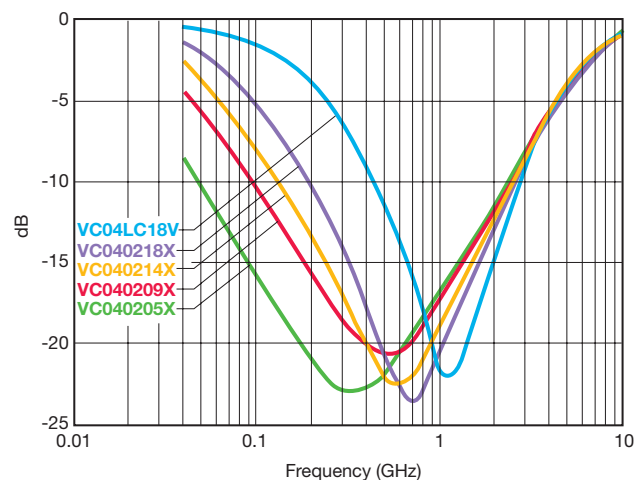

AVX Multilayer Ceramic Transient Voltage Suppressors

TYPICAL PERFORMANCE CURVES (0603, 0805, 1206 & 1210 CHIP SIZES)

VOLTAGE/CURRENT CHARACTERISTICS

Multilayer construction and improved grain structure result in excellent transient clamping characteristics up to 500 amps peak current, depending on case size and energy rating, while maintaining very low leakage currents under DC operating conditions. The VI curve below shows the voltage/current characteristics for the 3.3V, 5.6V, 12V, 14V, 18V, 26V, 30V, 48V and 60VDC parts with currents ranging from parts of a micro amp to tens of amps.

VI Curves - 3.3V and 5.6V Products

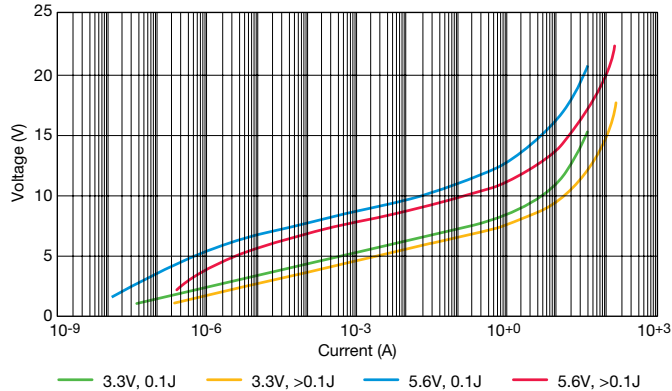

VI Curves - 9V, 12V, and 14V Products

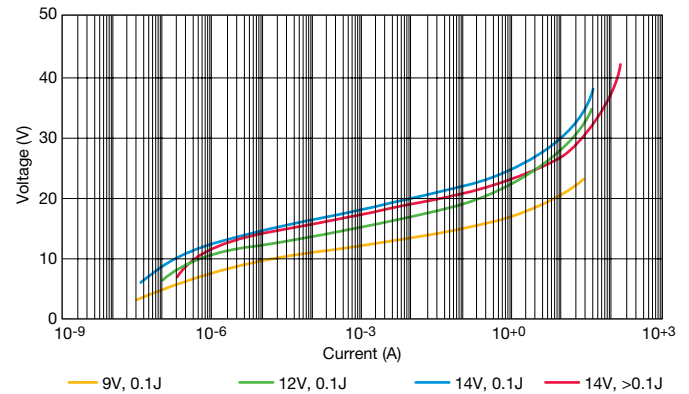

VI Curves - 18V and 26V Products

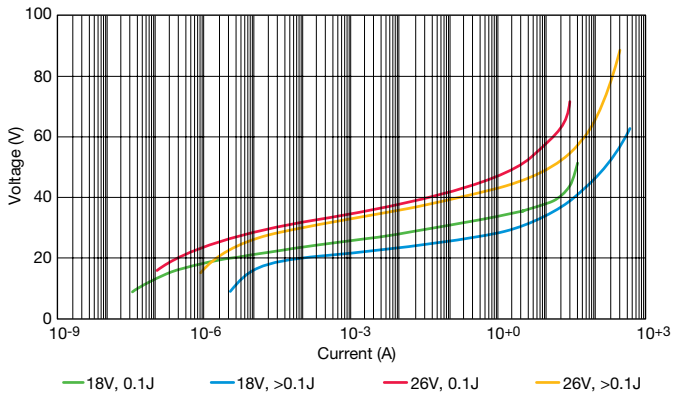

VI Curves - 30V, 48V, and 60V Products

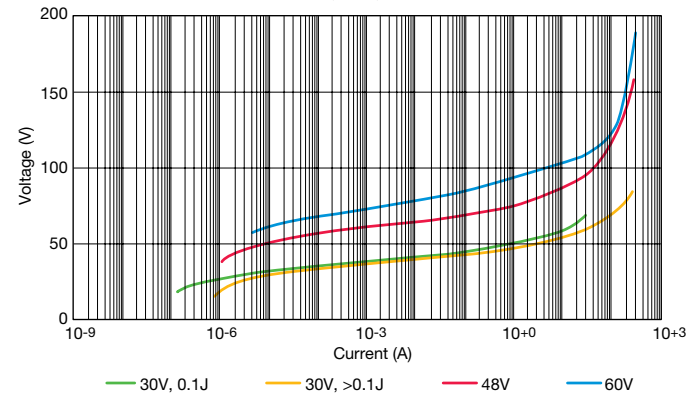

AVX Multilayer Ceramic Transient Voltage Suppressors

TYPICAL PERFORMANCE CURVES (0603, 0805, 1206 & 1210 CHIP SIZES)

TYPICAL PULSE RATING CURVE
3.3V MULTILAYER TRANSGUARD®

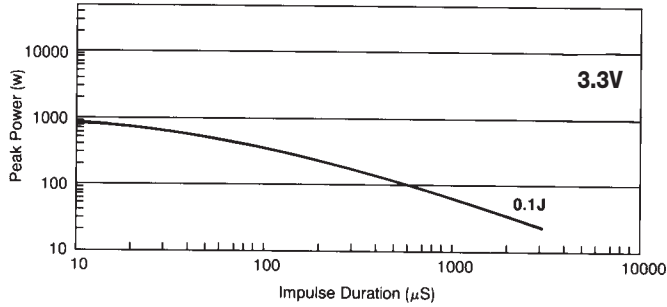

TYPICAL PULSE RATING CURVE
26V MULTILAYER TRANSGUARD®

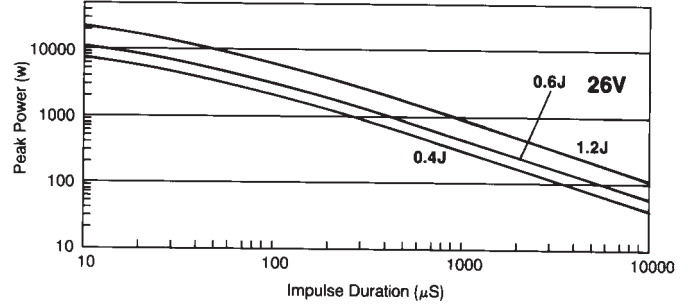

TYPICAL PULSE RATING CURVE
5.6V MULTILAYER TRANSGUARD®

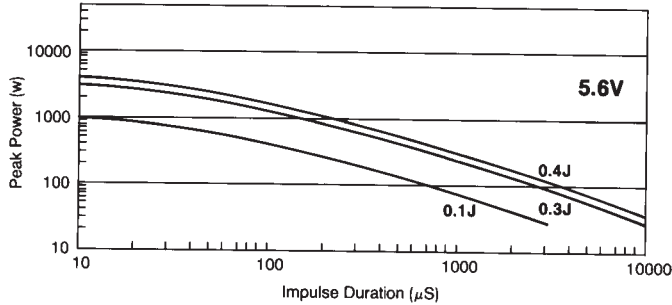

TYPICAL PULSE RATING CURVE
30V MULTILAYER TRANSGUARD®

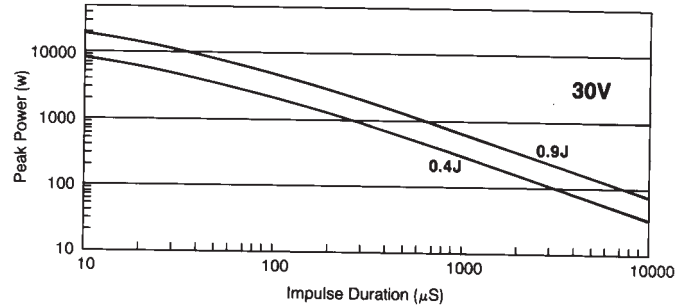

TYPICAL PULSE RATING CURVE
14V MULTILAYER TRANSGUARD®

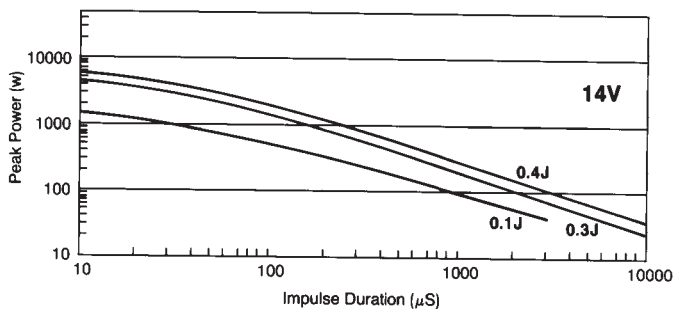

TYPICAL PULSE RATING CURVE
48V MULTILAYER TRANSGUARD®

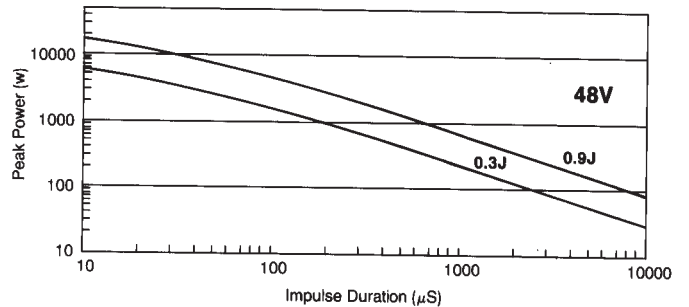

TYPICAL PULSE RATING CURVE
18V MULTILAYER TRANSGUARD®

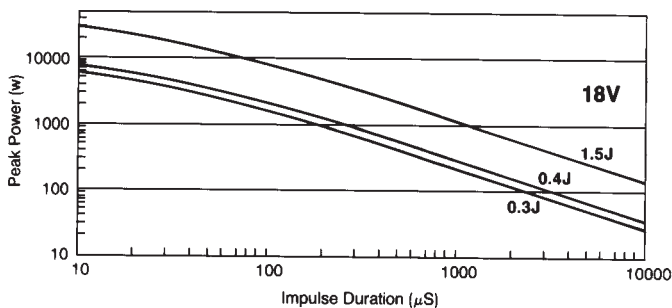

TYPICAL PULSE RATING CURVE
60V MULTILAYER TRANSGUARD®

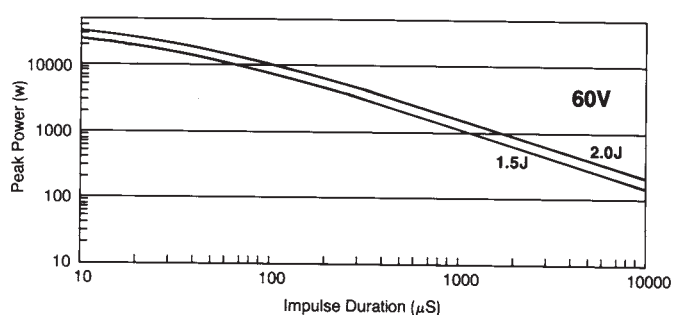

AVX Multilayer Ceramic Transient Voltage Suppressors

TYPICAL PERFORMANCE CURVES (0603, 0805, 1206 & 1210 CHIP SIZES)

TEMPERATURE CHARACTERISTICS

TransGuard® suppressors are designed to operate over the full temperature range from -55°C to +125°C. This operating temperature range is for both surface mount and axial leaded products.

Temperature Dependence of Voltage

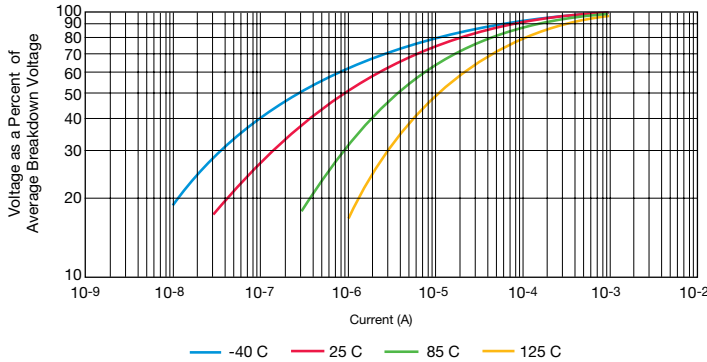

TYPICAL ENERGY DERATING VS TEMPERATURE

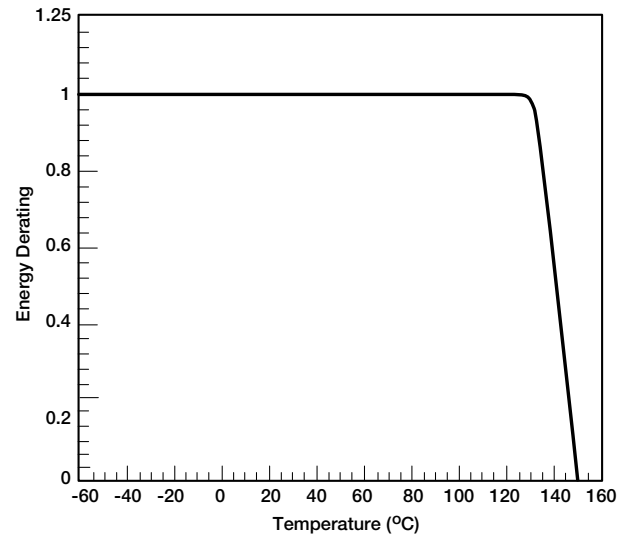

TYPICAL BREAKDOWN AND CLAMPING VOLTAGES VS TEMPERATURE - 5.6V

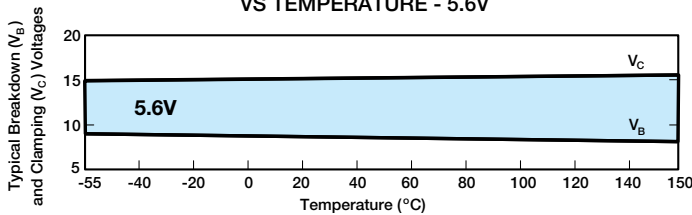

TYPICAL BREAKDOWN AND CLAMPING VOLTAGES VS TEMPERATURE - 18V

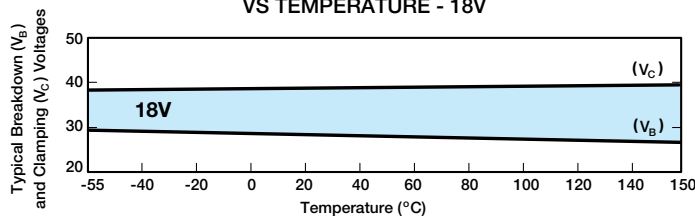

TYPICAL BREAKDOWN AND CLAMPING VOLTAGES VS TEMPERATURE - 26V

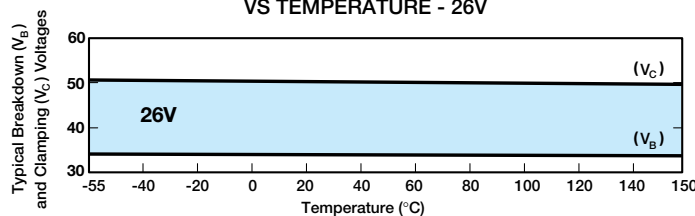

TYPICAL CAPACITANCE VS TEMPERATURE

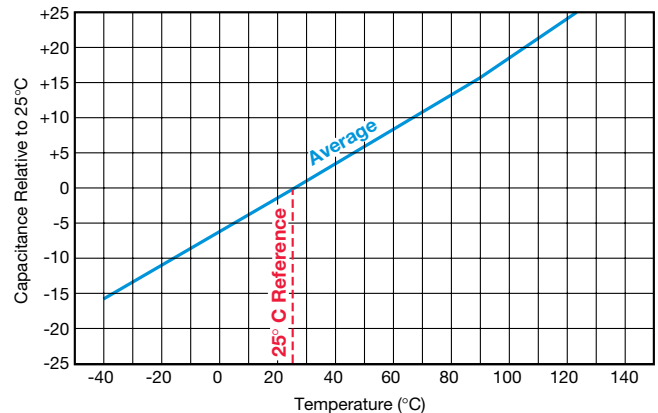

AVX Multilayer Ceramic Transient Voltage Suppressors

TYPICAL PERFORMANCE CURVES (0603, 0805, 1206 & 1210 CHIP SIZES)

PULSE DEGRADATION

Traditionally varistors have suffered degradation of electrical performance with repeated high current pulses resulting in decreased breakdown voltage and increased leakage current. It has been suggested that irregular intergranular boundaries and bulk material result in restricted current paths and other non-Schottky barrier paralleled conduction paths in the ceramic. Repeated pulsing of both 5.6 and 14V TransGuard transient voltage suppressors with

150 Amp peak 8 x 20µs waveforms shows negligible degradation in breakdown voltage and minimal increases in leakage current. This does not mean that TransGuard suppressors do not suffer degradation, but it occurs at much higher current. The plots of typical breakdown voltage vs number of 150A pulses are shown below.

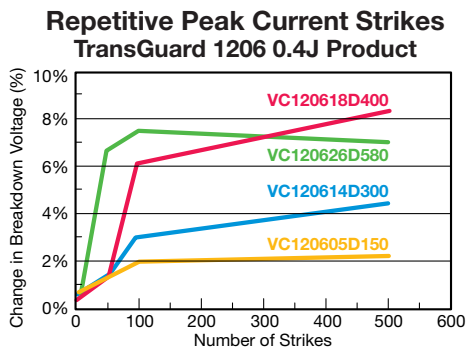

Figure 1

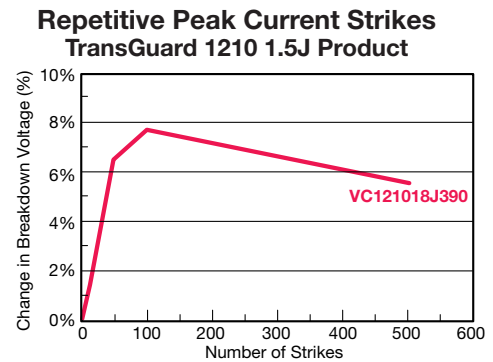

Figure 3

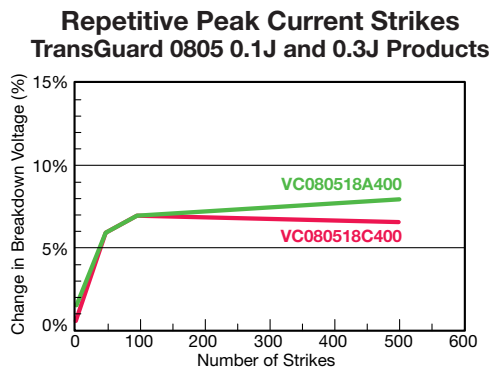

Figure 2

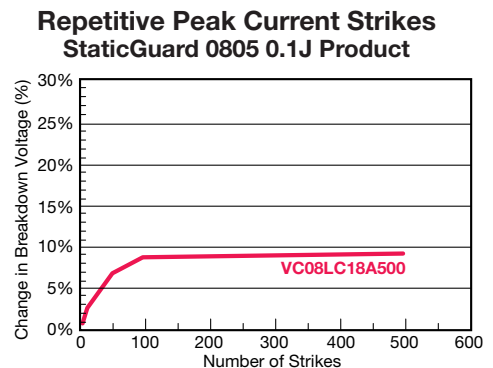
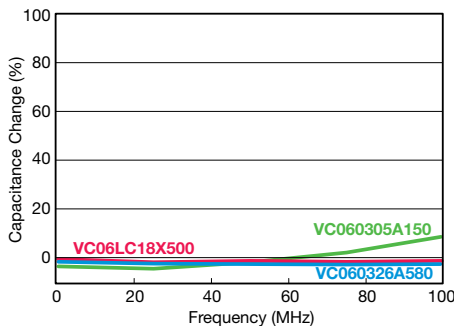

Figure 4

CAPACITANCE/FREQUENCY CHARACTERISTICS

TransGuard Capacitance vs Frequency 0603



TransGuard Capacitance vs Frequency 0805

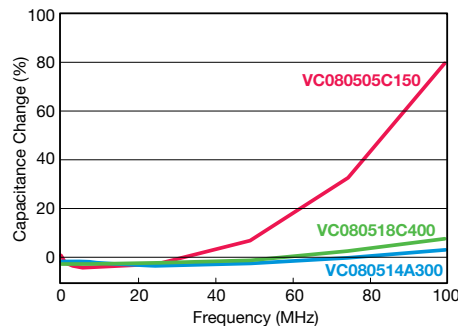

TransGuard Capacitance vs Frequency 1206

