



Parameter	Rating	Units
LED Operating Range	2-10	mA
K3, Transfer Gain	0.887-1.072	-
Isolation, Input to Output	3750	V <sub>rms</sub>

### Features

- Small 8-Pin Package
- Flatpack Package (PCMCIA Compatible)
- Couples Analog and Digital Signals
- Wide Bandwidth (>200kHz)
- High Gain Stability
- Low Input-to-Output Capacitance
- Low Power Consumption
- 0.01% Servo Linearity
- THD 87dB Typical
- Machine Insertable, Wave Solderable
- Surface Mount Tape and Reel Packaging Available
- VDE Compatible

### Applications

- Modem Transformer Replacement With No Insertion Loss
- Digital Telephone Isolation
- Power Supply Feedback Voltage/Current
- Medical Sensor Isolation
- Audio Signal Interfacing
- Isolation of Process Control Transducers

### Description

The LOC117 Linear Optocoupler features an infrared LED optically coupled to a pair of phototransistors. An input phototransistor provides the servomechanism used to generate a feedback control signal for the input LED drive current thus compensating for the LED's nonlinear time and temperature characteristics. The output phototransistor provides an isolated signal that is linear with respect to the servo LED current. LOC117 features include wide bandwidth, high input-to-output isolation, and excellent servo linearity.

### Approvals

- UL Recognized: File Number E76270
- CSA Certified: File Number LR 43639-10
- EN/IEC 60950-1:2001 Compliant

### Ordering Information

Part #	Description
LOC117	8-Pin DIP (50/tube)
LOC117P	8-Pin Flatpack (50/tube)
LOC117PTR	8-Pin Flatpack (1000/Reel)
LOC117S	8-Pin Surface Mount (50/tube)
LOC117STR	8-Pin Surface Mount (1000/Reel)

### Pin Configuration

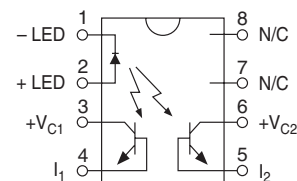

## Absolute Maximum Ratings

Parameter	Ratings	Units
Reverse Input Voltage	5	V
Input Control Current	100	mA
Peak (10ms)	1	A
Input Power Dissipation <sup>1</sup>	150	mW
Total Package Dissipation <sup>2</sup>	500	mW
Isolation Voltage Input to Output	3750	V <sub>rms</sub>
Operational Temperature	-40 to +85	°C
Storage Temperature	-40 to +125	°C

<sup>1</sup> Derate Linearly 1.33 mW/°C

<sup>2</sup> Derate Linearly 6.67 mW/°C

Electrical absolute maximum ratings are at 25°C

*Absolute Maximum Ratings are stress ratings. Stresses in excess of these ratings can cause permanent damage to the device. Functional operation of the device at conditions beyond those indicated in the operational sections of this data sheet is not implied.*

## Electrical Characteristics

Parameter	Conditions	Symbol	Min	Typ	Max	Units
<b>Input Characteristics @ 25°C</b>						
LED Voltage Drop	I <sub>F</sub> =2-10mA	V <sub>F</sub>	0.9	1.2	1.4	V
Reverse LED Current	V <sub>R</sub> =5V	I <sub>R</sub>	-	-	10	μA
<b>Coupler/Detector Characteristics @ 25°C</b>						
Dark Current	I <sub>F</sub> =0mA, V <sub>CB</sub> =15V	I <sub>CB0</sub>	-	1	25	nA
K1, Servo Gain (I <sub>1</sub> /I <sub>F</sub> )	I <sub>F</sub> =2-10mA, V <sub>CB1</sub> =15V	K1	0.008	-	0.030	-
K2, Forward Gain (I <sub>2</sub> /I <sub>F</sub> )	I <sub>F</sub> =2-10mA, V <sub>CB2</sub> =15V	K2	0.006	-	0.030	-
K3, Transfer Gain (K <sub>2</sub> /K <sub>1</sub> )	I <sub>F</sub> =2-10mA, V <sub>CB1</sub> =V <sub>CB2</sub> =15V	K3	0.887	1.0	1.072	-
ΔK3, Transfer Gain Linearity (non-servoed)	I <sub>F</sub> =2-10mA	ΔK3	-	-	1.0	%
K3 Temperature Coefficient	I <sub>F</sub> =2-10mA, V <sub>det</sub> =-5V	ΔK3/ΔT	-	0.005	-	%/°C
Common Mode Rejection Ratio	V=20V <sub>pp</sub> , R <sub>L</sub> =2KΩ, f=100Hz	CMRR	-	130	-	dB
Total Harmonic Distortion	f <sub>0</sub> =350Hz, 0dBm	THD	-96	-87	-80	dB
Frequency Response	Photoconductive Operation	f <sub>-3dB</sub>	-	200	-	kHz
	Photovoltaic Operation	f <sub>-3dB</sub>	-	40	-	kHz
<b>Common Characteristics @ 25°C</b>						
Input/Output Capacitance	-	C <sub>I/O</sub>	-	3	-	pF

**PERFORMANCE DATA\***

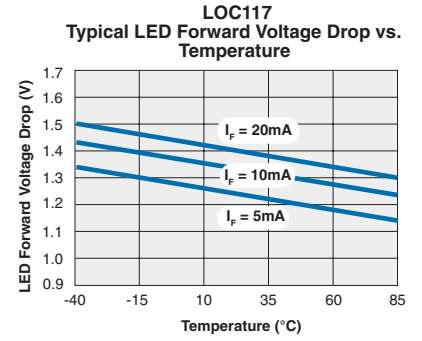
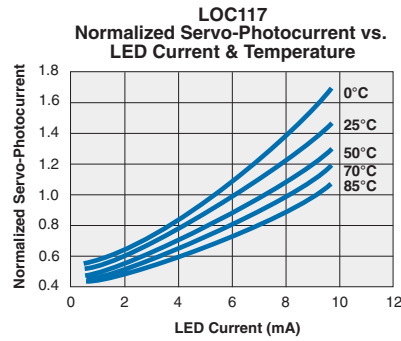
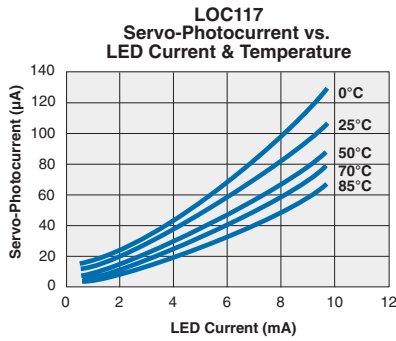
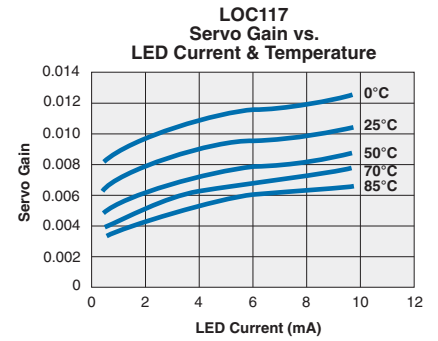
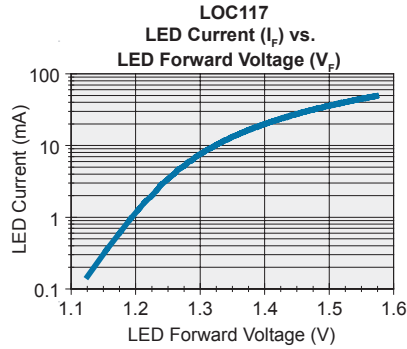
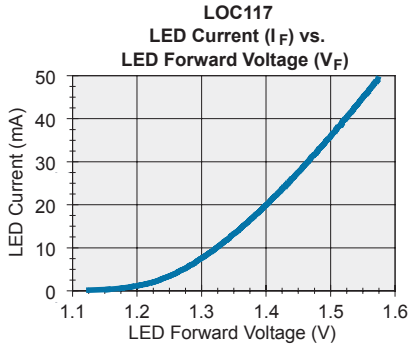

\*The Performance data shown in the graphs above is typical of device performance. For guaranteed parameters not indicated in the written specifications, please contact our application department.

**Manufacturing Information**

**Soldering**

For proper assembly, the component must be processed in accordance with the current revision of IPC/JEDEC standard J-STD-020. Failure to follow the recommended guidelines may cause permanent damage to the device resulting in impaired performance and/or a reduced lifetime expectancy.

Recommended soldering processes are limited to 260°C component body temperature for 10 seconds.

**Washing**

Clare does not recommend ultrasonic cleaning or the use of chlorinated solvents.



**MECHANICAL DIMENSIONS**

**8-Pin DIP Through Hole (Standard)**

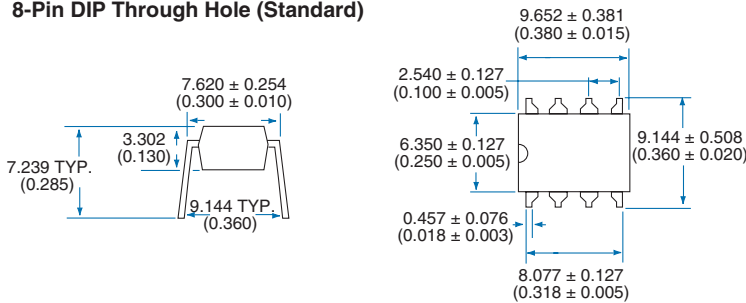

**PC Board Pattern (Top View)**

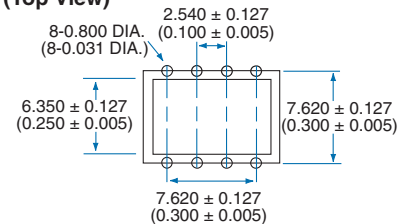

**8-Pin Surface Mount ("S" Suffix)**

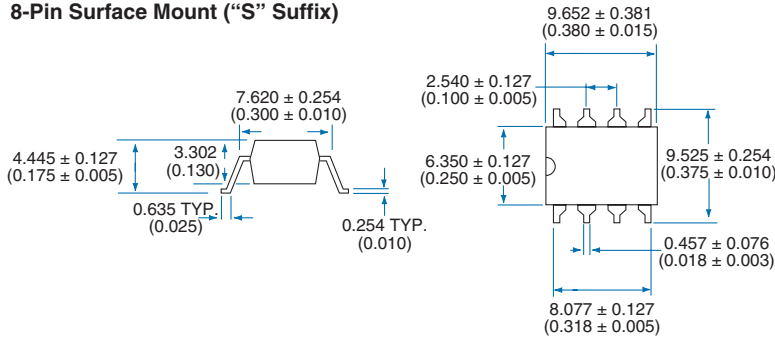

**PC Board Pattern (Top View)**

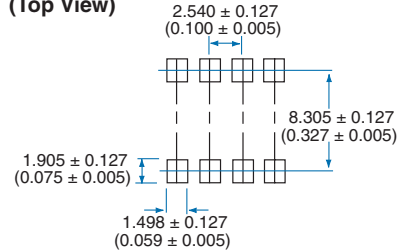

**8-Pin Flatpack ("P" Suffix)**

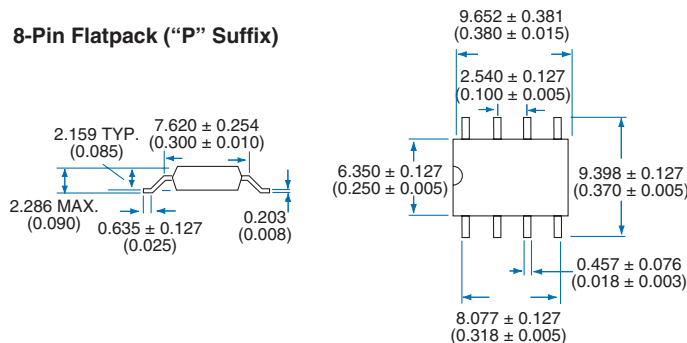

**PC Board Pattern (Top View)**

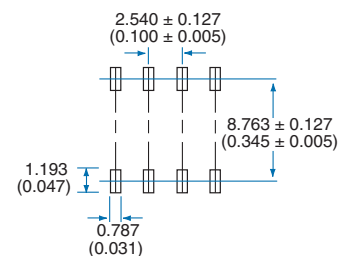

Dimensions:  
mm  
(inches)

## MECHANICAL DIMENSIONS

### Tape and Reel Packaging for 8-Pin Surface Mount Package

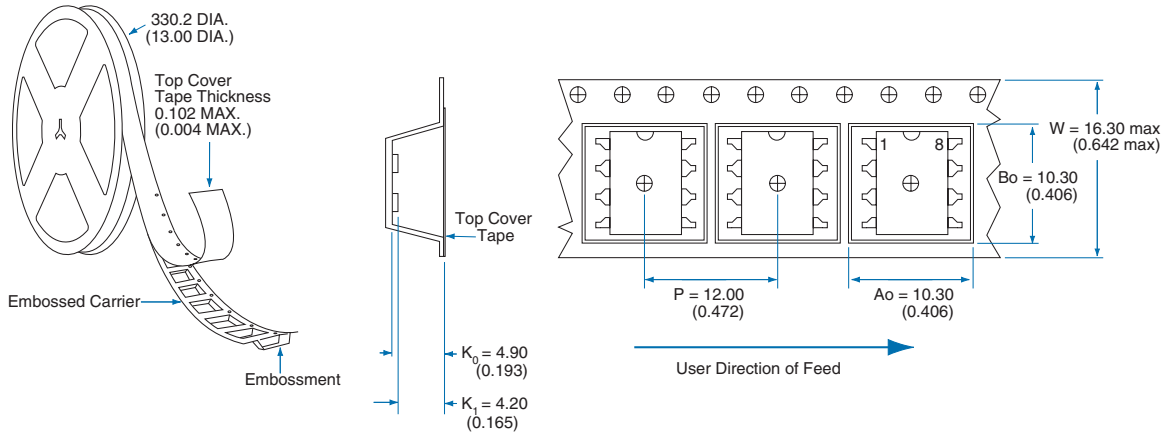

NOTE: Tape dimensions not shown, comply with JEDEC Standard EIA-481-2

### Tape and Reel Packaging for 8-Pin Flatpack Package

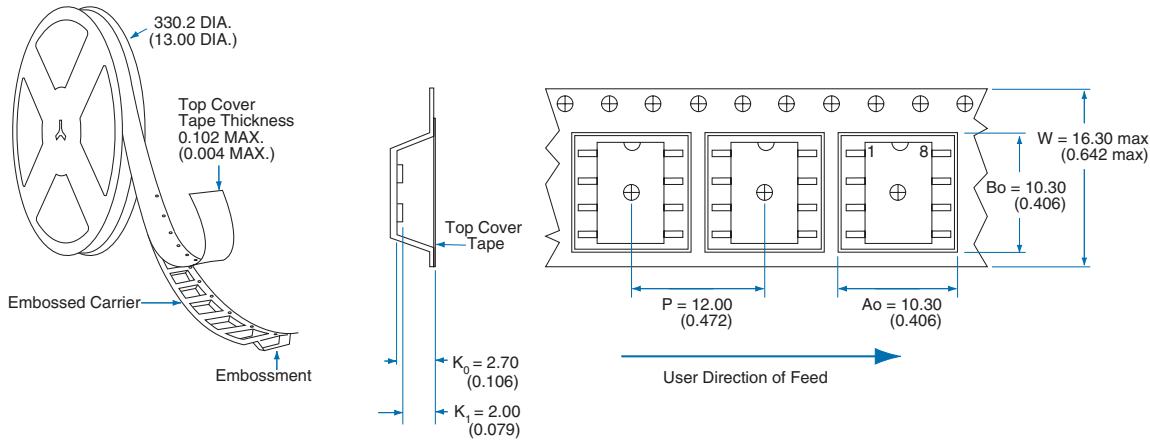

NOTE: Tape dimensions not shown, comply with JEDEC Standard EIA-481-2

Dimensions:  
mm  
(inches)

For additional information please visit our website at: [www.clare.com](http://www.clare.com)

Clare, Inc. makes no representations or warranties with respect to the accuracy or completeness of the contents of this publication and reserves the right to make changes to specifications and product descriptions at any time without notice. Neither circuit patent licenses nor indemnity are expressed or implied. Except as set forth in Clare's Standard Terms and Conditions of Sale, Clare, Inc. assumes no liability whatsoever, and disclaims any express or implied warranty, relating to its products including, but not limited to, the implied warranty of merchantability, fitness for a particular purpose, or infringement of any intellectual property right.

The products described in this document are not designed, intended, authorized or warranted for use as components in systems intended for surgical implant into the body, or in other applications intended to support or sustain life, or where malfunction of Clare's product may result in direct physical harm, injury, or death to a person or severe property or environmental damage. Clare, Inc. reserves the right to discontinue or make changes to its products at any time without notice.

Specification: DS-LOC117-R01  
©Copyright 2006, Clare, Inc.  
OptoMOS® is a registered trademark of Clare, Inc.  
All rights reserved. Printed in USA.  
10/26/06