

APPLICATIONS

- Compassing
- Navigation Systems
- Attitude Reference
- Traffic Detection
- Proximity Detection
- Medical Devices

Three-Axis Magnetic Sensor Hybrid

HMC2003

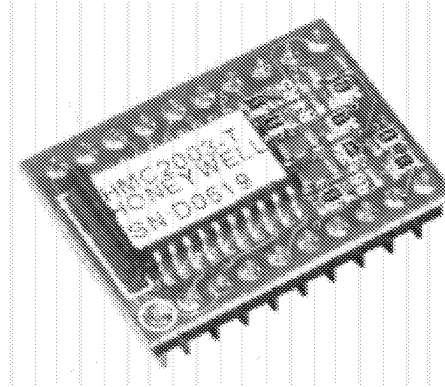

A complete 3-axis magnetometer with analog output in a 20-pin hybrid DIP package. Uses Honeywell's sensitive HMC1001 and HMC1002 MR sensors and precision instrumentation amplifiers to measure x, y and z axes. Patented integral field straps are accessible for applying offset fields or closed loop operation.

FEATURES AND BENEFITS

Small Cost Effective Package	DIP-20 footprint (1 in. x .75 in.) allows easy insertion into system-level boards, reducing development costs.
Solid State	All components are solid state, improving reliability and ruggedness compared to mechanical fluxgates.
Wide Dynamic Range	Accurately measures fields from 40 micro-gauss to ± 2 gauss at 1V/gauss. Low noise instrumentation amplifiers with 1kHz low pass filters, reject unwanted noise. There are no flux concentrators used in this design that can lead to hysteresis and non-repeatability.
Internal Reference	An externally accessible +2.5V reference improves measurement accuracy and stability. An on-board excitation current source reduces temperature errors and regulates the power supply input.
Offset and Set/Reset Straps	Magnetic field offsets or closed loop circuits can be applied using the built-in straps. Output signal accuracy may be enhanced by using the integral set/reset straps.
Non-Magnetic Material	All components are especially selected and packaged in nonmagnetic material to reduce magnetic distortion and offsets.

HMC2003

GENERAL DESCRIPTION

Honeywell's three-axis magnetic sensor hybrid uses three permalloy magnetoresistive transducers and custom interface electronics to measure the strength and direction of a magnetic field. These transducers are sensitive to magnetic fields along the length, width, and height (x, y, z axis) of the 20-pin dual-in-line hybrid. Fields can be detected less than 40 microgauss and up to ± 2 gauss. Analog outputs are available for each x, y, z, axis from the hybrid. With the sensitivity and linearity of this hybrid, changes can be detected in the earth's magnetic field to provide compass headings or attitude sensing. The high bandwidth of this hybrid allows anomaly detection of vehicles, planes and other ferrous objects at high speeds.

The hybrid is packaged on a small board (1 in. x 0.75 in.) and has an on-chip voltage reference that operates from a single 6 to 15 V supply. The hybrid is ideal for applications that require two- or three-axis magnetic sensing and have a very tight size constraint and/or have their own electronics and only need a magnetic transducer front-end.

Integrated with the transducer bridge circuit is a magnetically coupled strap that replaces the need for external coils and provides various modes of operation. The Honeywell patented field offset straps (Xoff+ and Xoff-, etc.) can be used to electrically apply a magnetic field to the bridge to buck, or offset an applied field. This technique can be used to cancel unwanted ambient magnetic fields or in a closed loop field nulling measurement circuit. The offset straps

nominally provide a 1 gauss field along the sensitive axis per 48 mA of offset current through it.

Magnetic transducers can be affected by high momentary magnetic fields that may lead to output signal degradation. In order to eliminate this effect, and maximize the signal output, a magnetic switching technique can be applied to the bridge using the SR+ and SR- pins that eliminates the effect of past magnetic history. Refer to AN-201 for applications information on Set/Reset operation.

CIRCUIT DIAGRAM

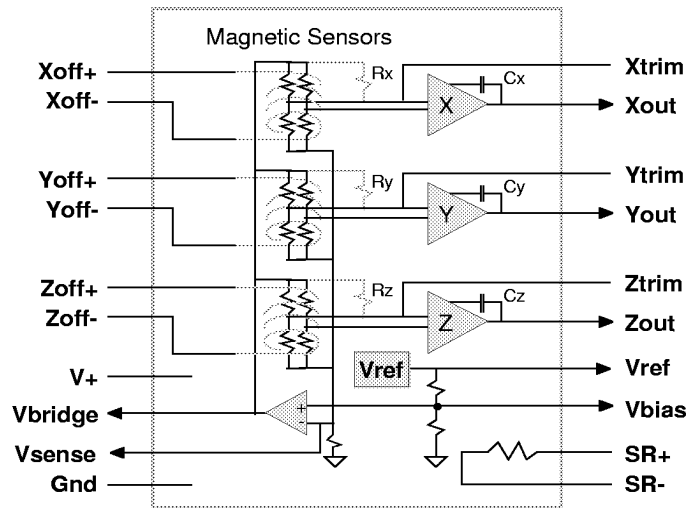

PINOUT DIAGRAM

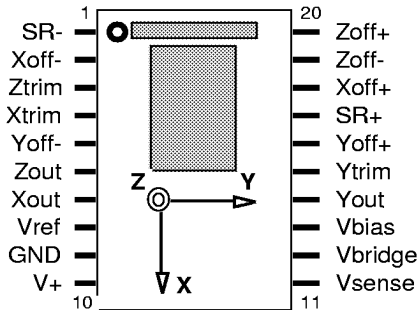

PACKAGE DRAWING

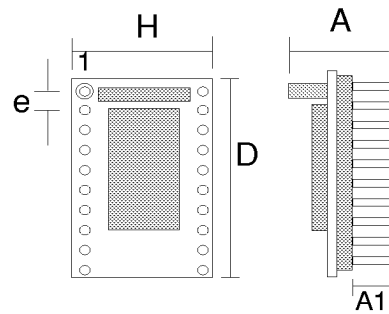

Symbol	Millimeters		Inches	
	Min	Max	Min	Max
A	11.43	12.45	0.45	0.49
A1	4.06	5.08	0.16	0.20
D	25.91	26.92	1.02	1.06
e	2.41	2.67	0.095	0.105
H	18.03	19.05	0.71	0.75

KEY PERFORMANCE DATA

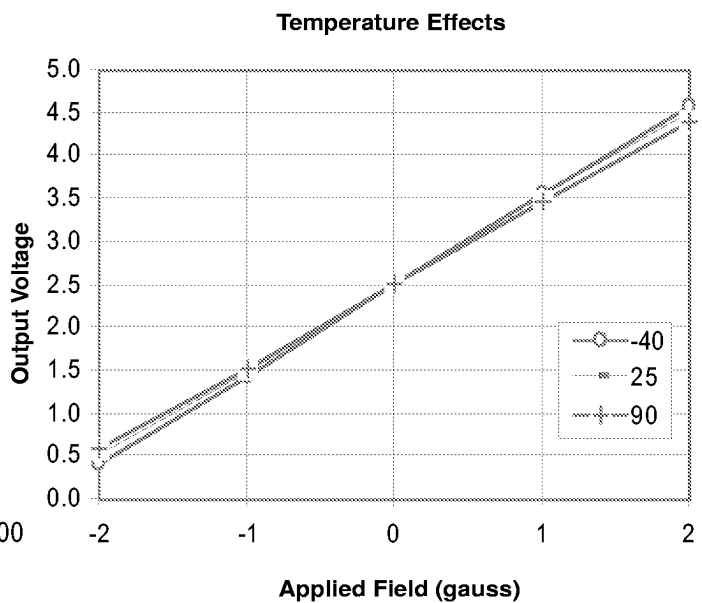
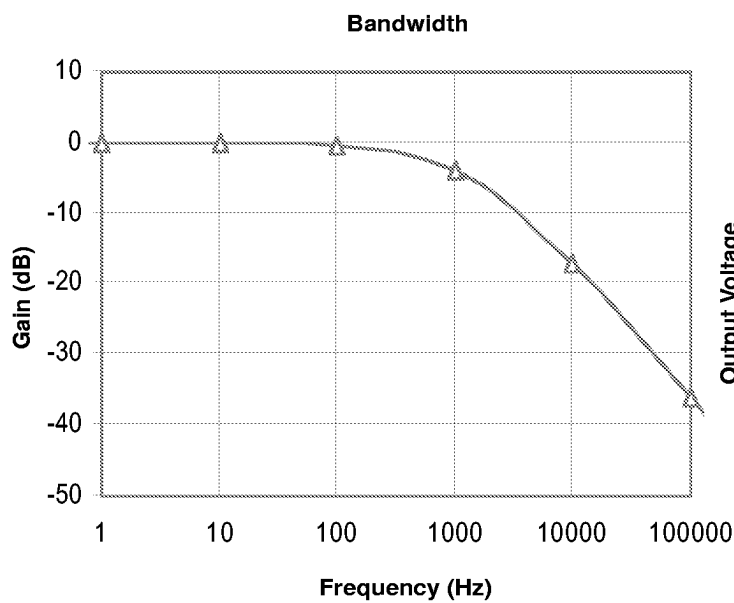
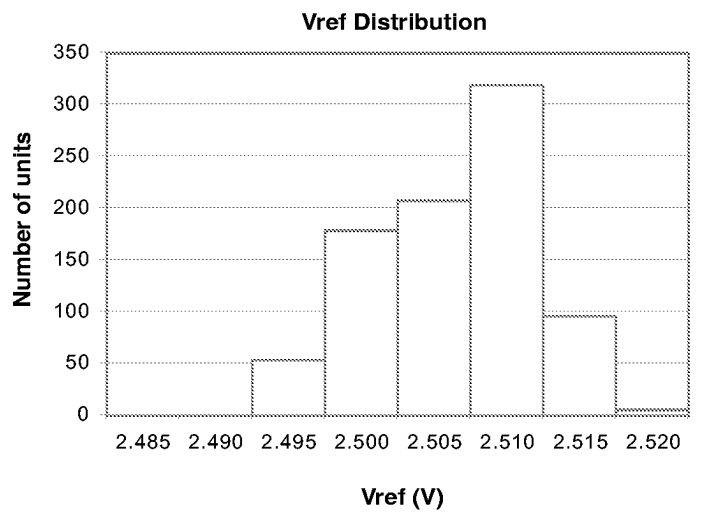
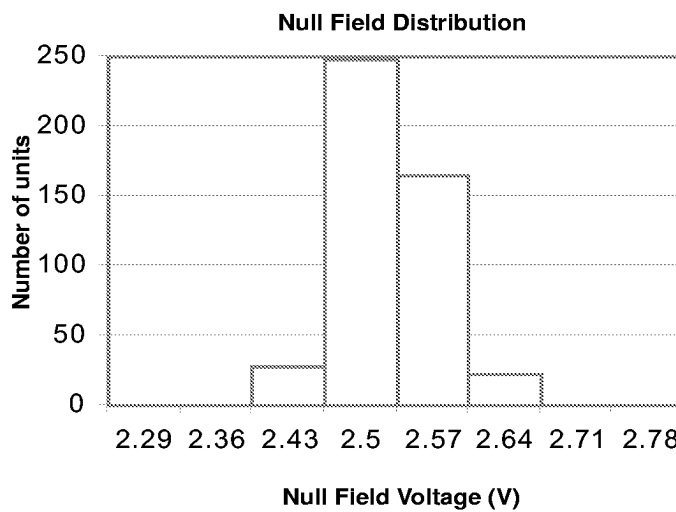
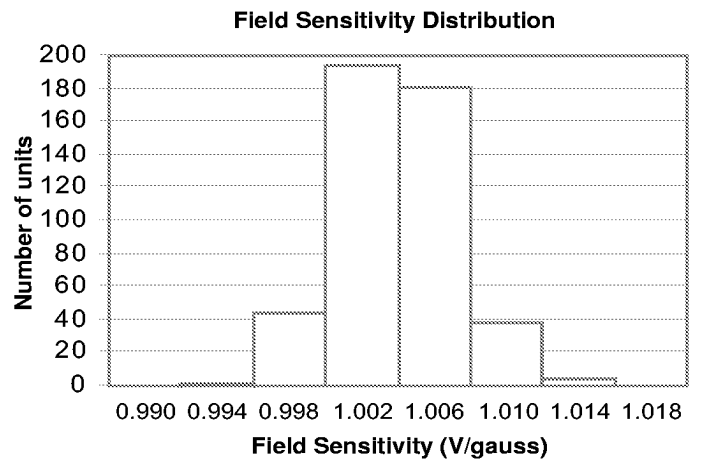
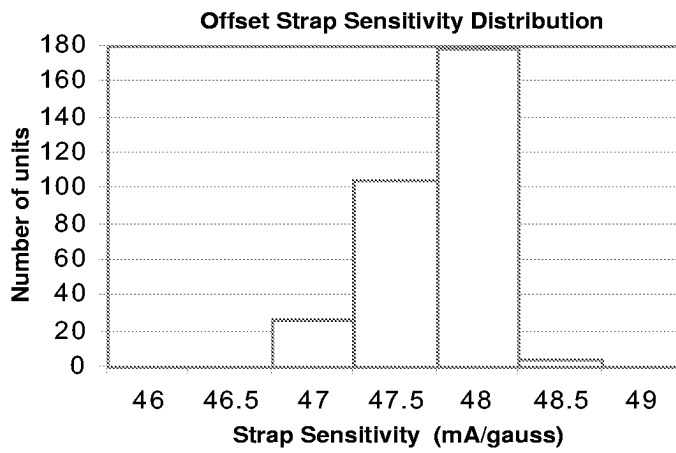

SPECIFICATIONS

Characteristic	Conditions ⁽¹⁾	Min	Typ	Max	Units ⁽²⁾
Supply Voltage ⁽³⁾		6		15	VDC
Supply Current				20	mA
Field Range		-2		2	gauss
Output Voltage		0.5		4.5	V
Resolution			40		μgauss
Bandwidth			1		KHz
Field Sensitivity		0.98	1	1.02	V/gauss
Null Field Output		2.3	2.5	2.7	V
Linearity Error	±1 gauss Applied Field Sweep		0.5	2	%FS
Linearity Error	±2 gauss Applied Field Sweep		1	2	%FS
Hysteresis Error	3 sweeps across ±2 gauss		0.05	.1	%FS
Repeatability Error	3 sweeps across ±2 gauss		0.05	.1	%FS
Offset Strap Resistance				10.5	Ω
Offset Strap Sensitivity		46.5	47.5	48.5	mA/gauss
Offset Strap Current				200	mA
Set/Reset Strap Resistance				6	Ω
Field Sensitivity Tempco			-600		ppm/° C
Null Field Tempco	Set/Reset not used		±400		ppm/° C
Null Field Tempco	Set/Reset used		±100		ppm/° C
Storage Temperature		-55		125	° C
Operating Temperature		-40		85	° C
Shock			100		g
Vibration			2.2		g rms
Power Supply Effect (shifts in Null Field Offset or Sensitivity)	Power Supply varied from 6 to 15VDC with ±1 gauss Applied Field sweep			0.1	%FS

(1). Unless otherwise stated, test conditions are as follows: power supply = +12VDC, ambient temp = 25°C, Set/Reset switching is active.

(2). Units: 1 gauss (G) = 1 Oersted (in air), 1G = 79.58 A/m, 1G = 10E-4 Tesla, 1G = 10E5 gamma.

(3). Transient protection circuitry should be added across V+ and Gnd if an unregulated power supply is used.

Honeywell reserves the right to make changes to any products or technology herein to improve reliability, function or design. Honeywell does not assume any liability arising out of the application or use of any product or circuit described herein; neither does it convey any license under its patent rights nor the rights of others.

Honeywell

Solid State Electronics Center
12001 State Highway 55
Plymouth, MN 55441
1-800-323-8295
E-Mail: clr@mn14.ssec.honeywell.com • <http://www.ssec.honeywell.com>
900151 Rev. C 10-97

Helping You Control Your World