

7000h at 85°C

- Larger Size Components
- Long Useful Life
- High Ripple Current
- Industrial Power Supplies

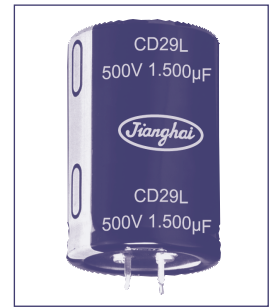
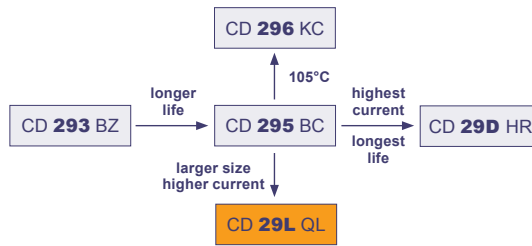

Item	Characteristics	
Operating Temperature Range (°C)	-40 ~ +85	-25 ~ +85
Voltage Range (V)	16 ~ 400	450 ~ 500
Capacitance Range (µF)	390 ~ 120 000	
Capacitance Tolerance (20°C, 120Hz)	± 20%	
Leakage Current (µA)	After 5 minutes at 20°C application of rated voltage, leakage current is not more than 0,01CV or 1,5mA, whichever is smaller C: Nominal Capacitance (µF) V: Rated Voltage (V)	
Dissipation Factor (20°C, 120Hz)	Rated Voltage (V)	16 25 35 50 63~100 160~250 350~450 500
	Tan δ (max)	0,60 0,50 0,40 0,30 0,20 0,15 0,15
Stability at Low Temperature (Impedance Ratio at 120Hz)	Rated Voltage (V)	16~35 50~100 160~200 250~400 450 500
	$Z_{-25°C} / Z_{+20°C}$	4 3 3 4
	$Z_{-40°C} / Z_{+20°C}$	15 10 6 8 -

	Useful Life		Load Life	Endurance Test	Shelf Life
Lifetime	7000h	>100 000h	5000h	5000h	1000h
Leakage Current	Not more than specified value		Not more than specified value	Not more than specified value	Not more than specified value
Capacity Change	Within ± 30% of initial value		Within ± 20% of initial value	Within ± 20% of initial value	Within ± 20% of initial value
Dissipation Factor	Not more than 300% of specified value		Not more than 200% of specified value	Not more than 130% of specified value	Not more than 200% of specified value
Condition: Applied Voltage Applied Current Applied Temperature Failure Rate Level	U_R I_R 85°C ≤ 1% Failure Rate	U_R $1,2 \times I_R$ 40°C ≤ 1% Failure Rate	U_R I_R 85°C guaranteed	U_R $I_R = 0$ 85°C	$U_R = 0$ $I_R = 0$ 85°C <div style="border: 1px solid black; padding: 2px;">After test: U_R to be applied for 30min >24h before measurement</div>

Multiplier for Ripple Current

Frequency Coefficient

Rated Voltage (V)	Frequency				
	50Hz	120Hz	1kHz	10kHz	100kHz
≤ 50	0,95	1,00	1,10	1,15	1,15
63 ~ 100	0,90	1,00	1,16	1,30	1,33
≥ 160	0,85	1,00	1,20	1,35	1,40

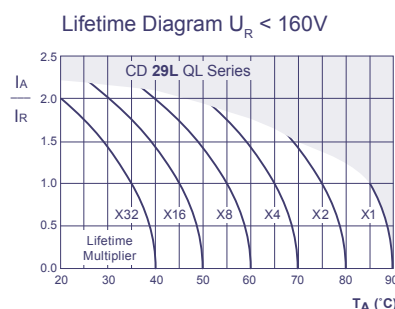

I_A = actual ripple current at 120Hz,
 I_R = rated ripple current at 120Hz, 85°C
Multiplier of Useful Life as a function of ambient temperature and ripple current load

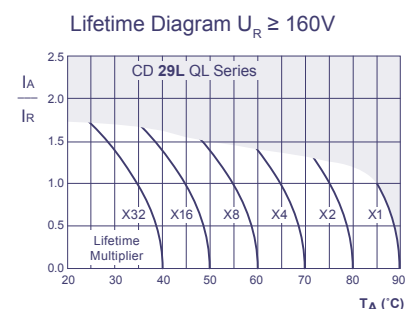

I_A = actual ripple current at 120Hz,
 I_R = rated ripple current at 120Hz, 85°C
Multiplier of Useful Life as a function of ambient temperature and ripple current load

Ratings for CD 29L QL Series

V _{DC} (Surge Voltage) Code	Rated Capacitance	Max ESR 20°C, 120Hz	Typ ESR 20°C, 120Hz	Max Ripple Current 85°C, 120Hz	Size Ø D x L
(V)	(µF)	(mΩ)	(mΩ)	(Arms)	(mm)
16 (20) 1C	56 000	14,3	10,0	10,4	35 x 45
		14,3	10,0	9,8	40 x 40
	68 000	11,8	8,2	10,8	35 x 50
		11,8	8,2	11,5	40 x 50
	82 000	9,8	6,8	11,8	35 x 60
		9,8	6,8	11,8	40 x 50
	100 000	8,0	5,6	13,2	35 x 80
		8,0	5,6	13,5	40 x 60
	120 000	6,7	4,7	15,3	35 x 105
		6,7	4,7	14,8	40 x 80
25 (32) 1E	33 000	20,1	14,1	8,1	35 x 40
		20,1	14,1	8,7	40 x 40
	39 000	17,1	12,0	9,0	35 x 45
		17,1	12,0	9,6	40 x 40
	47 000	14,2	9,9	9,6	35 x 50
		11,9	8,3	10,3	35 x 60
	56 000	11,9	8,3	10,8	40 x 50
		9,8	6,9	11,3	35 x 80
68 000	9,8	6,9	11,8	40 x 60	
	8,1	5,7	13,5	40 x 80	
35 (44) 1V	27 000	19,7	13,8	8,2	35 x 45
		19,7	13,8	8,0	40 x 40
	33 000	16,1	11,3	8,7	35 x 50
		13,7	9,6	10,3	35 x 60
	39 000	13,7	9,6	9,6	40 x 50
		11,3	8,0	11,4	35 x 80
	47 000	11,3	8,0	10,8	40 x 60
		9,5	6,7	12,1	40 x 70
56 000	9,5	6,7	12,1	40 x 70	
	7,9	5,5	14,2	40 x 80	
50 (63) 1H	15 000	27,0	18,6	7,7	35 x 40
		27,0	18,6	8,1	40 x 40
	18 000	23,0	15,5	8,3	35 x 45
		23,0	15,5	8,3	40 x 40
	22 000	18,1	12,7	9,1	35 x 50
		18,1	12,7	9,4	40 x 50
	27 000	14,8	10,4	11,2	35 x 80
		14,8	10,4	10,8	40 x 60
33 000	12,1	8,5	11,0	35 x 80	
	12,1	8,5	14,4	40 x 70	
39 000	10,3	7,2	12,8	40 x 80	
	23,0	15,5	8,7	35 x 50	
63 (79) 1J	12 000	23,0	15,5	8,6	40 x 40
		17,7	12,4	10,2	35 x 70
	15 000	17,7	12,4	9,5	40 x 50
		14,8	10,4	11,2	35 x 80
80 (100) 1K	18 000	14,8	10,4	10,7	40 x 60
		9,9	6,9	12,7	40 x 80
	8 200	33,0	22,7	6,9	35 x 50
		27,0	18,6	8,7	35 x 60
100 (125) 2A	10 000	23,0	15,5	9,7	35 x 70
		23,0	15,5	9,0	40 x 50
	12 000	17,7	12,4	10,5	35 x 80
		17,7	12,4	10,2	40 x 60
	15 000	14,8	10,4	12,3	40 x 80
		48	34	7,0	35 x 45
160 (200) 2C	5 600	48	34	7,4	40 x 40
		40	28	8,0	35 x 50
	6 800	40	28	8,9	40 x 50
		33	23	9,6	35 x 70
	8 200	33	23	9,6	40 x 60
		27	19	10,4	35 x 80
	10 000	27	19	10,2	40 x 60
		23	16	12,3	40 x 80
200 (250) 2D	2 200	91	64	4,9	35 x 45
		74	52	5,3	35 x 50
	2 700	61	43	5,5	35 x 70
		61	43	5,5	40 x 60
	3 900	52	35	5,9	35 x 80
		43	30	7,3	40 x 80
250 (300) 2E	1 500	133	93	4,3	35 x 40
		180	111	4,7	35 x 45
	2 200	91	64	5,4	35 x 50
		91	64	5,4	40 x 40
350 (400) 2V	680	293	205	3,6	35 x 45
		293	205	3,6	40 x 40
	820	243	170	4,5	35 x 60
		243	170	4,3	40 x 50
400 (450) 2G	1 000	199	140	5,2	35 x 70
		199	140	4,9	35 x 70
	1 200	199	140	4,9	40 x 60
		166	117	5,6	35 x 80
	1 500	166	117	5,5	40 x 70
		133	93	6,2	45 x 70
	1 800	133	93	6,5	40 x 80
		111	78	7,1	45 x 70
450 (500) 2W	2 200	91	64	8,7	40 x 100
		111	78	7,9	40 x 100
	560	356	249	3,2	35 x 50
		356	249	2,8	40 x 40
	680	293	205	3,7	35 x 60
		293	205	3,8	40 x 50
	820	243	170	4,2	35 x 60
		243	170	4,1	40 x 50
1 000	199	140	4,9	35 x 70	
	199	140	4,8	40 x 60	
500 (550) 2H	1 200	166	117	5,8	35 x 80
		166	117	5,5	40 x 60
	1 500	133	93	6,6	40 x 80
		133	93	6,9	40 x 90
	1 800	133	93	6,8	45 x 80
		111	78	7,9	40 x 100
	2 200	111	78	7,3	45 x 80
		424	297	3,0	35 x 50
550 (550) 2H	470	424	297	3,0	40 x 40
		356	249	3,0	35 x 50
	560	356	249	3,3	35 x 60
		356	249	3,4	40 x 50
	680	293	205	3,8	35 x 60
		293	205	4,1	35 x 70
	820	293	205	3,8	40 x 50
		243	170	4,6	35 x 80
	1 000	243	170	4,4	40 x 60
		199	140	5,7	35 x 80
	1 200	199	140	5,2	40 x 60
		166	117	5,9	40 x 70
1 500	166	117	5,9	45 x 70	
	133	93	7,3	40 x 100	
550 (550) 2H	390	133	93	7,0	45 x 70
		111	78	7,9	45 x 100
	470	511	358	1,9	35 x 50
		424	297	2,3	35 x 60
	560	356	249	2,5	35 x 60
		356	249	2,4	40 x 60
	680	293	205	3,1	35 x 80
		293	205	2,8	40 x 70
820	243	170	3,4	35 x 90	
	243	170	3,3	40 x 70	
1 000	199	140	3,9	40 x 80	
	199	140	3,3	45 x 70	
1 200	166	117	4,3	40 x 90	
	133	93	4,8	40 x 100	

Snap-In

Custom products are available on request.

Order Code **SMD, Radial, Snap-In**

EC	R	1C	PT	101	M	FF	25	0611	JExxxxx
Technology	Terminal Type	Rated Voltage Code	Series Code	Capacitance Code (in μF)	Capacitance Tolerance	Lead Form	Terminal/Pitch Size	Dimension	for Specials only
EC = Electrolytic Capacitor	SMD = V Radial = R	For coding please refer to the pages of ratings	CD VS = BS	0,47 = R47	$\pm 20\%$ = M	SMD: = FF		4x7 = 0407	
			CD VH = VH	1,0 = 010	$\pm 10\%$ = K	Terminal = T2		5x11,5 = 0511	
PC = Polymer Capacitor	Snap-In = S		CD VZ = VZ	2,2 = 2R2	+30 / -10% = Q	Radial:		6,3x11,5 = 0611	
			CD 261 = LK	100 = 101	+50 / -10% = T	Long Lead = LL	2,0mm = 20	35x80 = 3580	
			CD 261X = QX	1000 = 102		Cut 5,0mm = CB	2,5mm = 25	45x100 = 45100	
			CD 262 = QM	10000 = 103		Cut 4,5mm = CC	3,5mm = 35		
			CD 263 = BK			Cut 4,0mm = CD	5,0mm = 50		
			CD 269 = PH			Cut 3,5mm = CE	7,5mm = 75		
			CD 281 = LL			Cut 3,0mm = CF	10,0mm = 10		
			CD 284 = XY			on request: alternative lead forms (axial, 90° - angle, others)		12,5mm = 12	
			CD 287 = GC			Snap-In:			
			CD 28L = QL			4,0mm Pin Length = T4	2 Pin = P2		
			CD 293 = BZ			6,3mm Pin Length = T6	3 Pin = P3		
			CD 294 = BW			Soldering Pin = S4	4 Pin = P4		
			CD 295 = BC				5 Pin = P5		
			CD 296 = KC			preferred			
			CD 297 = BB						
			CD 299 = PG						
			CD 29D = HR						
			CD 29H = QH						
			CD 29L = QL						
			HCP = CP						
			HPM = PM						
			HVC = VC						

Technical Specification **SMD Type**

Dimensions

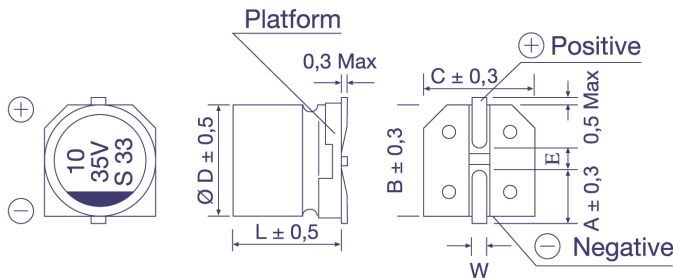

Ø D x L	4x5,4	5x5,4	6,3x5,4	6,3x7,7	8x10,5	8x11,8	10x10,5	10x12,7
A	1,8	2,1	2,4	2,5	2,9	2,9	3,2	3,2
B	4,3	5,3	6,6	6,6	8,3	8,4	10,3	10,4
C	4,3	5,3	6,6	6,6	8,3	8,4	10,3	10,4
E	1,0	1,3	2,2	2,2	3,1	3,1	4,5	4,5
L	5,4	5,4	5,4	7,7	10,5	11,8	10,5	12,7
W	0,5 - 0,8				0,7 - 1,1			

in mm

Taping Dimensions

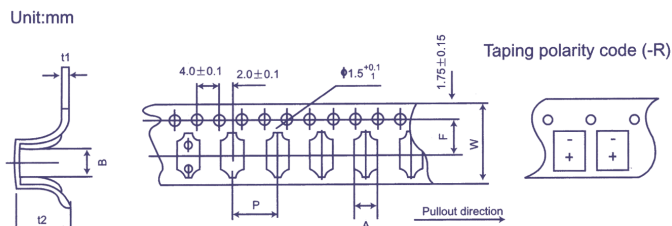

Size (DxL)	w ± 0,3	A ± 0,2	B ± 0,2	P ± 0,1	t2 ± 0,2	F ± 0,1	t1 ± 0,1
4 x 5,4	12,0	5,0	5,0	8,0	5,8	5,5	0,4
5 x 5,4	12,0	6,0	6,0	12,0	5,8	5,5	0,4
6,3 x 5,4	16,0	7,0	7,0	12,0	5,8	7,5	0,4
6,3 x 7,7	16,0	7,0	7,0	12,0	8,4	7,5	0,4
8 x 10,5	24,0	8,7	8,7	16,0	11,0	11,5	0,5
8 x 11,8	24,0	8,7	8,7	16,0	12,3	11,5	0,5
10 x 10,5	24,0	10,7	10,7	16,0	11,0	11,5	0,5
10 x 12,7	24,0	10,7	10,7	16,0	14,0	11,5	0,5

in mm

Soldering Profile (Aluminium Electrolytic Capacitors)

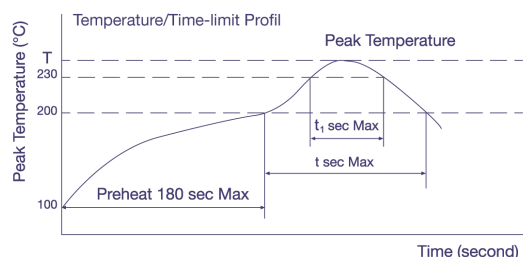

Allowable Range of Peak Temperature

Size	T (°C)	t (second)	t ₁ (second)
Ø 4 ~ 6,3	250	90	40
Ø 8 x 10,5	240	90	30
Ø 10 x 10,5	235	60	30

Diameter	w	D
4; 5	14 ± 1	50 ± 1
6,3	18 ± 1	50 ± 1
8; 10	25 ± 1	50 ± 1
Polymer	25 ± 1	80 ± 1

in mm

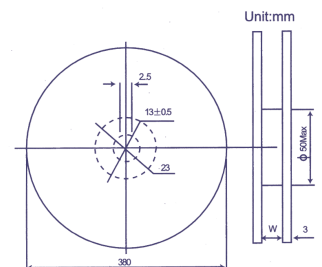

For more details or Soldering Profiles of Radials or Polymer-Capacitors please contact our local Sales Offices.

Technical Specification **Snap-In Type**

Pin Type: Snap-In
Order Code: T6, T4

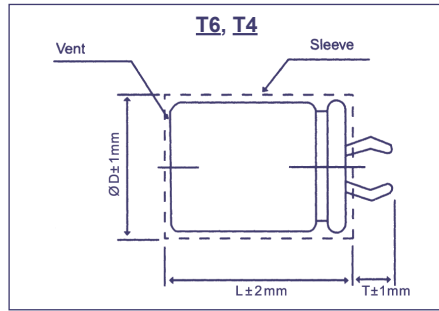

Terminal	T6	T4
Pin Length T	6,3	4,0

Pin Type: Soldering
Order Code: S4

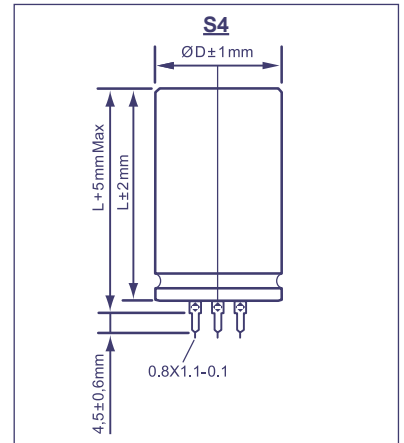

Snap-In Terminal
Order Code: P2, P3, P4

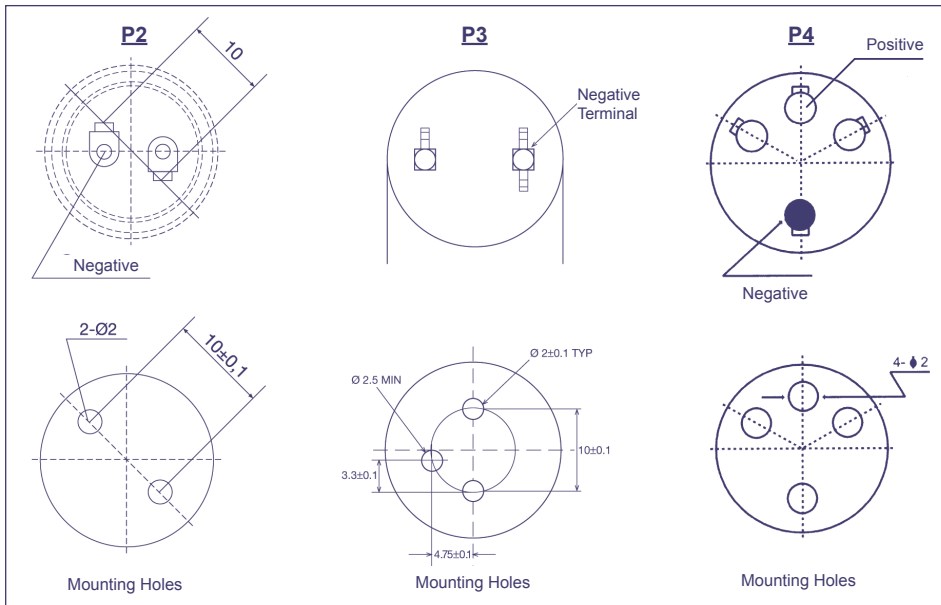

Soldering Terminal
Order Code: P5

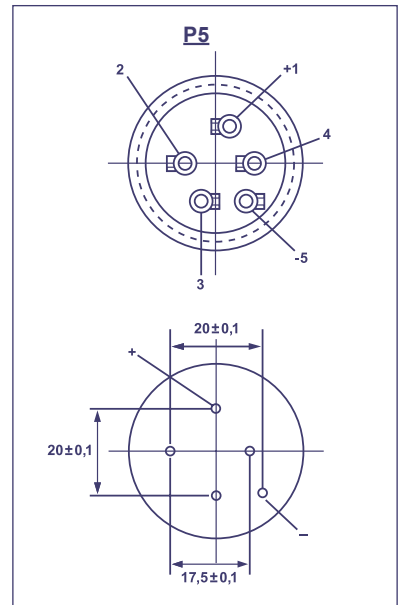

P3 only T4 Terminal

Order Code **Screw Type**

EC	G	1C	BP	101	M	B	E	160	A361	JExxxxx
Technology	Terminal Type	Rated Voltage Code	Series Code	Capacitance Code	Capacitance Tolerance	Mounting	Diameter	Length	For Terminal Code see tables below	for Specials only
EC = Electrolytic Capacitor	Screw = G	For coding please refer to the pages of ratings	CD 135 = BP	100 = 101	±20% = M	Bolt = B	36 = A	53 = 053		
			CD 136 = PK	1000 = 102	±10% = K	No double sleeve = N	40 = B	65 = 065		
			CD 137 = PX	10000 = 103	+30 / -10% = Q	2 stoppers bracket+double sleeve* = I	51 = C	96 = 096		
			CD 138 = PC		+20 / -0% = R	3 stoppers bracket+double sleeve* = Y	64 = D	100 = 100		
			CD 139 = BL		+50 / -10% = T	No bracket, but double sleeve* = D	77 = E	115 = 115		
					preferred	* Double sleeve for diameter ≥ 51 only	90 = F	236 = 236		
							101 = G			

Technical Specification **Screw Type**

Dimensions

Standard Housing
Order Code: I, Y, D, N

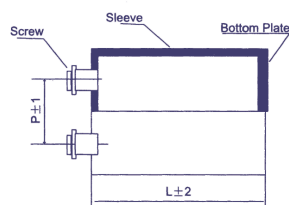
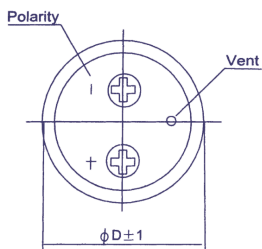

Bolt Housing
Order Code: B

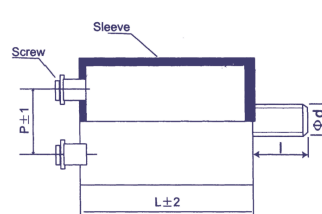

Ø D	Ø d	l
Ø 36	M8	12
≥ Ø 51	M12	16

in mm