

**2MP04-096 Series**

Type	$\Delta T_{max}$ K	$Q_{max}$ W	$I_{max}$ A	$U_{max}$ V	AC R Ohm	H mm	h mm
2MP04-096-xx (N=96+96)							
2MP04-096-10	92	2.45	1.65	4.70	2.32	3.2	1
2MP04-096-12	95	2.26	1.66	4.97	2.42	3.4	1.2
2MP04-096-15	98	1.99	1.66	5.25	2.53	3.7	1.5

Performance data are given for  $T_{hot}=300K$  vacuum

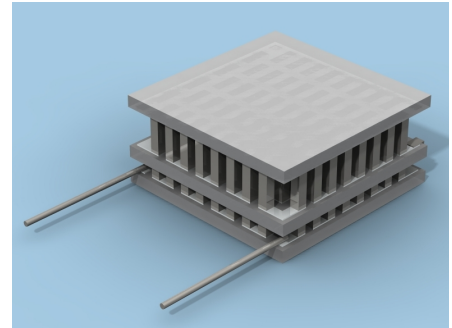

**Technical Drawing**

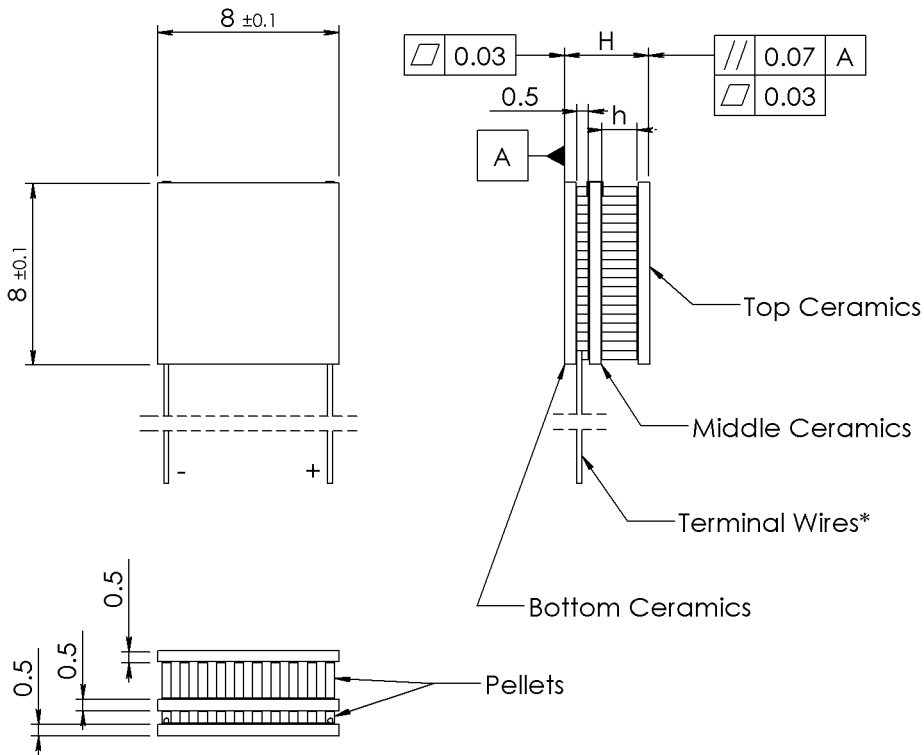

\* Terminal Wires - Copper pre-tinned, 0.27mm dia

**Ordering Options**

**A. TEC Assembly:**

1. Solder PbSn ( $T_{melt}=183^{\circ}C$ )
2. Solder SnSb ( $T_{melt}=230^{\circ}C$ )

**B. Ceramics:**

1. Pure  $Al_2O_3$  (100%)
2. Alumina ( $Al_2O_3$  - 96%)
3. Aluminum Nitride (AlN)

**C. Surface Finish (one or both):**

1. Clear ceramics
2. Metallized:
  - 2.1 Ni / Sn(Bi)
  - 2.2 Gold plating
3. Metallized and pre-tinned:
  - 3.1 Rose alloy (Pb-Sn-Bi,  $T_{melt}=94^{\circ}C$ )
  - 3.2 Solder 117 (In-Sn,  $T_{melt}=117^{\circ}C$ )
  - 3.3 Solder 138 (Sn-Bi,  $T_{melt}=138^{\circ}C$ )
  - 3.4 Solder 183 (Pb-Sn,  $T_{melt}=183^{\circ}C$ )

**D. Thermistor can be mounted on edge of cold side ceramics. Calibration is available.**

2MP04-096-10

Standard Performance Plots

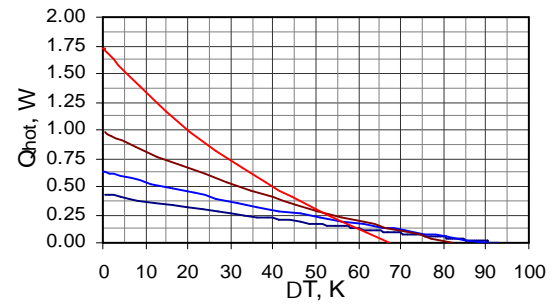
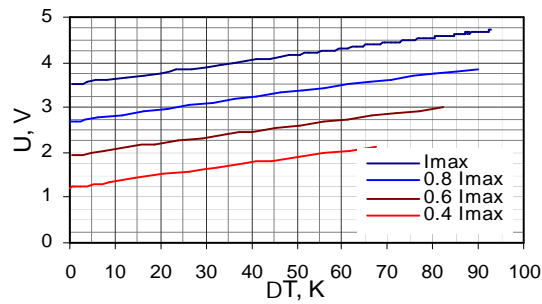
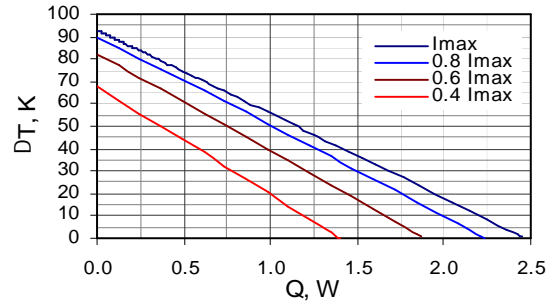
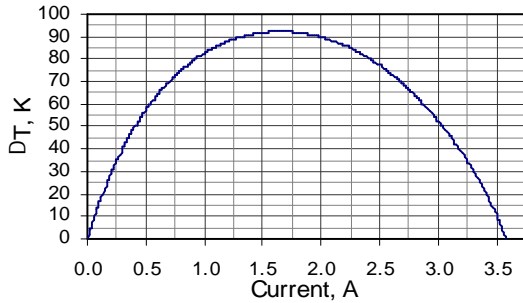

2MP04-096-12

Standard Performance Plots

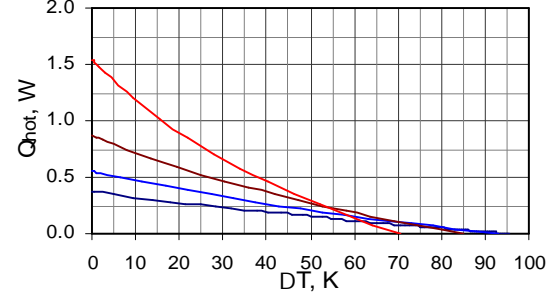
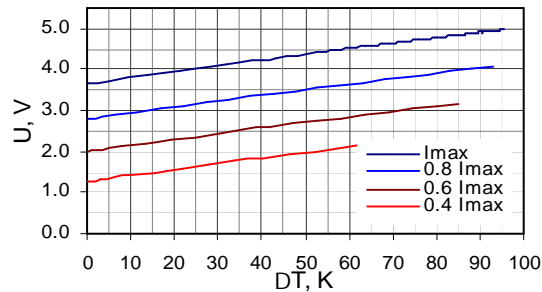
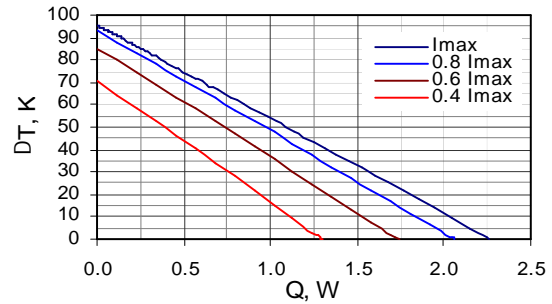
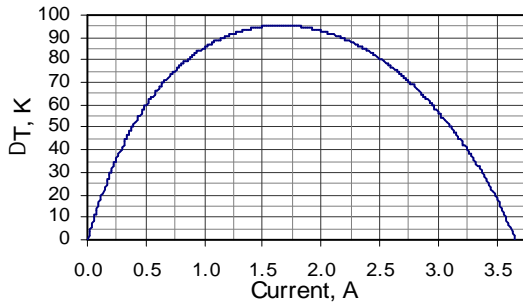

Performance plots are created with TECCAD Software. TECCAD is available for free download from RMT Ltd. website - [www.rmtltd.ru](http://www.rmtltd.ru)

53 Leninskij prosp. Moscow 119991 Russia, phones: 7-095-132-6817, 7-095-132-6685, fax: 7-095-132-5870, e-mail: [rmtcom@dol.ru](mailto:rmtcom@dol.ru)

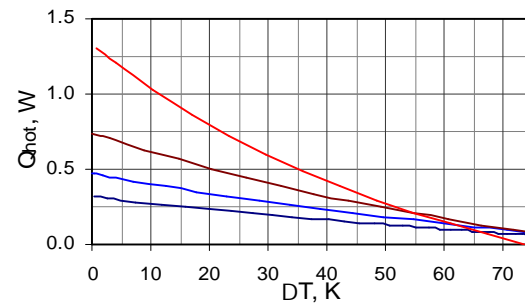
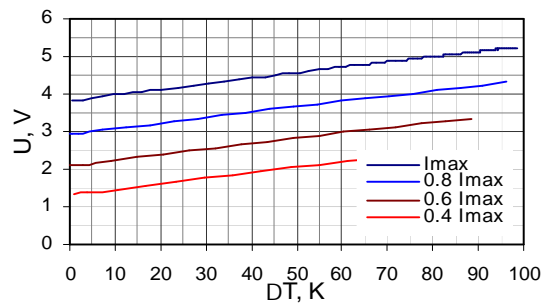
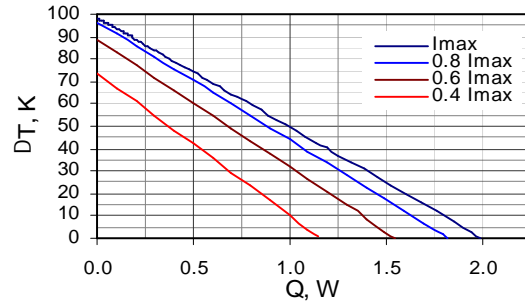
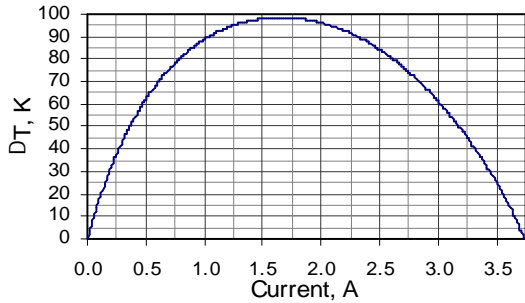

Application tips

Cautions

1. Never heat TE module more than 160°C (TEC assembled at 183°C) or 200°C (TEC assembled at 230°C).
2. Never use TE module without attached heat sink at hot (bottom) side.
3. Connect TE module to DC power supply according to polarity
4. Do not apply DC current higher than I<sub>max</sub>.

Installation

1. Mechanical Mounting

TEC is placed between two heat exchangers. This construction is fixed by screws or in another mechanical way. It is suitable for large modules (with dimensions 30mmx30mm and larger). Miniature types require other assembling methods.

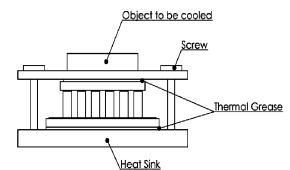

2. Soldering

This method is suitable for a TE module with metallized outside surfaces (cold and hot sides). RMT provides this option and also makes pre-tinning for TE modules. In comparison with a mechanical assembling method, soldering requires careful procedures.

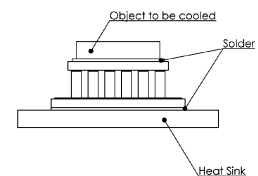

3. Glueing

It is an up-to-date method that is used by many customers due to availability of glues with good thermoconductive properties. A glue is usually based on some epoxy compound filled with some thermoconductive material such as graphite or diamond powders, silver, SiN and others. The application of a specific type depends on application features and the type of a TE module.

