

FEATURES

- **HIGH BREAKDOWN VOLTAGE SiGe TECHNOLOGY**
V_{CEO} = 5 V (Absolute Maximum)
- **HIGH OUTPUT POWER:**
P_{1dB} = 21 dBm at 2 GHz
- **LOW NOISE FIGURE:**
NF = 0.9 dB at 2 GHz
- **HIGH MAXIMUM STABLE POWER GAIN:**
MSG = 17 dB at 2 GHz
- **LOW PROFILE M05 PACKAGE:**
SOT-343 footprint, with a height of only 0.59 mm
Flat lead style for better RF performance

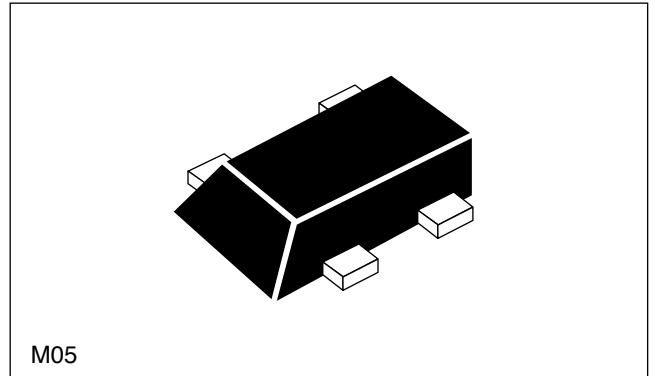

DESCRIPTION

NEC's NESG2101M05 is fabricated using NEC's high voltage Silicon Germanium process (UHS2-HV), and is designed for a wide range of applications including low noise amplifiers, medium power amplifiers, and oscillators

NEC's low profile, flat lead style M05 Package provides high frequency performance for compact wireless designs.

ELECTRICAL CHARACTERISTICS (T_A = 25°C)

PART NUMBER PACKAGE OUTLINE		NESG2101M05 M05				
SYMBOLS	PARAMETERS AND CONDITIONS	UNITS	MIN	TYP	MAX	
RF	P _{1dB}	Output Power at 1 dB Compression Point V _{CE} = 3.6 V, I _{CQ} = 10 mA, f = 2 GHz	dBm		21	
	GL	Linear Gain, V _{CE} = 3.6 V, I _{CQ} = 10 mA, f = 2 GHz	dB		15	
	NF	Noise Figure at V _{CE} = 2 V, I _C = 10 mA, f = 2 GHz, Z _S = Z _{SOPT} , Z _L = Z _{LOPT}	dB		0.9	1.2
	G _a	Associated Gain at V _{CE} = 2 V, I _C = 10 mA, f = 2 GHz, Z _S = Z _{SOPT} , Z _L = Z _{LOPT}	dB	11.0	13.0	
	NF	Noise Figure at V _{CE} = 2 V, I _C = 7 mA, f = 1 GHz, Z _S = Z _{SOPT} , Z _L = Z _{LOPT}	dB		0.6	
	G _a	Associated Gain at V _{CE} = 2 V, I _C = 7 mA, f = 1 GHz, Z _S = Z _{SOPT} , Z _L = Z _{LOPT}	dB		19.0	
	MSG	Maximum Stable Gain ¹ at V _{CE} = 3 V, I _C = 50 mA, f = 2 GHz	dB	14.5	17.0	
	IS _{21EI} ²	Insertion Power Gain at V _{CE} = 3 V, I _C = 50 mA, f = 2 GHz	dB	11.5	13.5	
	f _T	Gain Bandwidth Product at V _{CE} = 3 V, I _C = 50 mA, f = 2 GHz	GHz	14	17	
	C _{re}	Reverse Transfer Capacitance ² at V _{CB} = 2 V, I _C = 0 mA, f = 1 MHz	pF		0.4	0.5
DC	I _{CBO}	Collector Cutoff Current at V _{CB} = 5V, I _E = 0	nA			100
	I _{EBO}	Emitter Cutoff Current at V _{EB} = 1 V, I _C = 0	nA			100
	h _{FE}	DC Current Gain ³ at V _{CE} = 2 V, I _C = 15 mA		130	190	260

Notes:

$$1. \text{MSG} = \left| \frac{S_{21}}{S_{12}} \right|$$

2. Collector to base capacitance is measured by capacitance meter (automatic balance bridge method) when emitter pin is connected to the guard pin.

3. Pulsed measurement, pulse width ≤ 350 μs, duty cycle ≤ 2 %.

NESG2101M05

ABSOLUTE MAXIMUM RATINGS¹ (T_A = 25°C)

SYMBOLS	PARAMETERS	UNITS	RATINGS
V _{CB0}	Collector to Base Voltage	V	13.0
V _{CEO}	Collector to Emitter Voltage	V	5.0
V _{EB0}	Emitter to Base Voltage	V	1.5
I _C	Collector Current	mA	100
P _T ²	Total Power Dissipation	mW	500
T _J	Junction Temperature	°C	150
T _{STG}	Storage Temperature	°C	-65 to +150

Note:

1. Operation in excess of any one of these parameters may result in permanent damage.
2. Mounted on 38 x 38 x 0.4 mm (t) glass epoxy substrate

THERMAL RESISTANCE

SYMBOLS	PARAMETERS	UNITS	RATINGS
R _{th j-c}	Junction to Case Resistance	°C/W	TBD

ORDERING INFORMATION

PART NUMBER	QUANTITY	SUPPLYING FORM
NESG2101M05-T1-A	3 kpcs/reel	<ul style="list-style-type: none"> • Pin 3 (Collector), Pin 4 (Emitter) face the perforation side of the tape • 8 mm wide embossed taping

TYPICAL PERFORMANCE CURVES (T_A = 25°C)

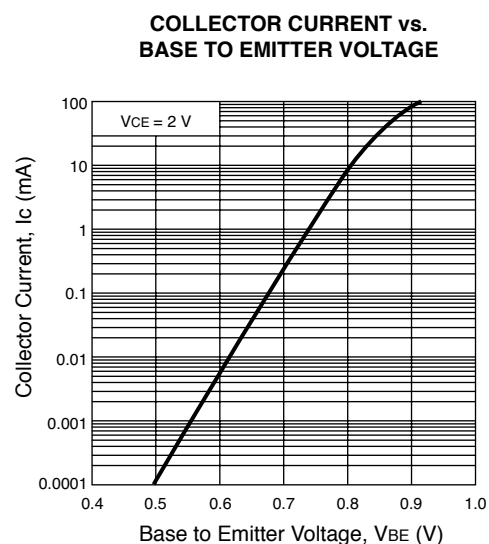
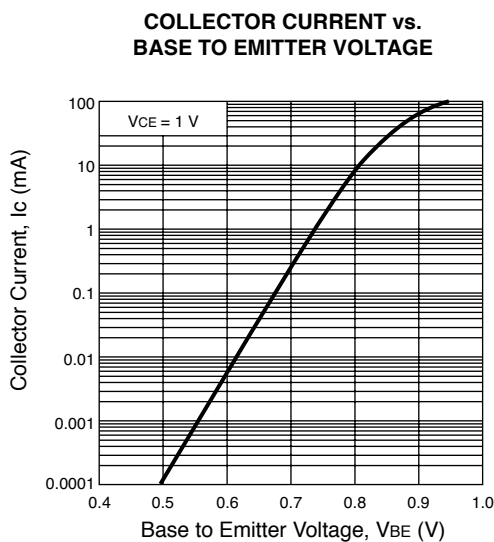
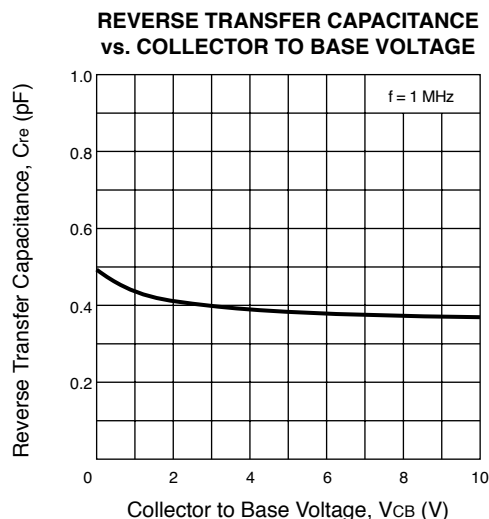
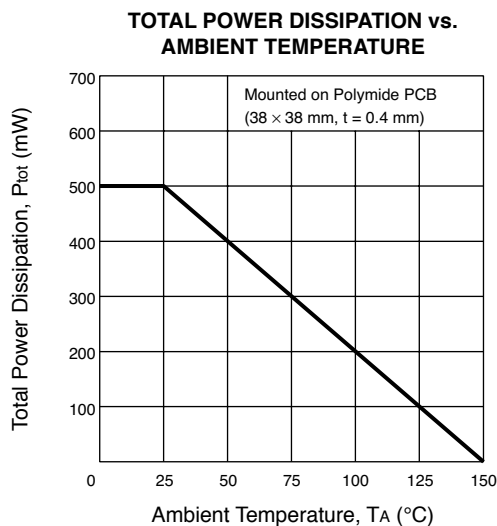

TYPICAL PERFORMANCE CURVES ($T_A = 25^\circ\text{C}$)

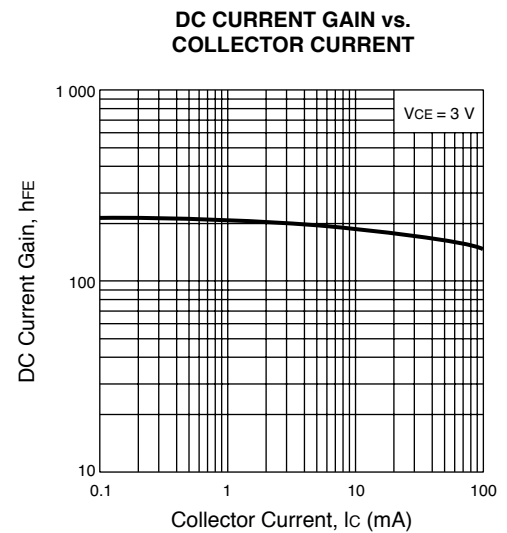
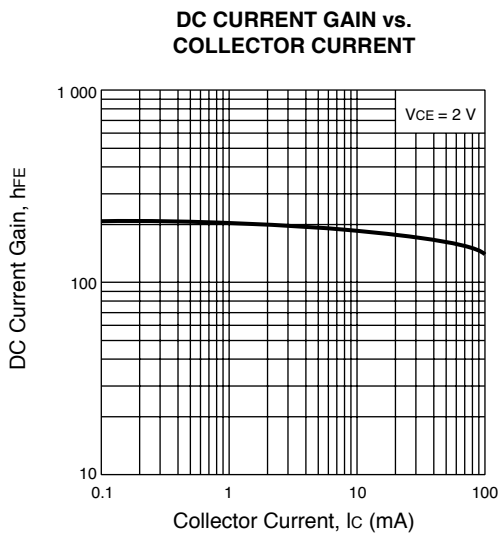
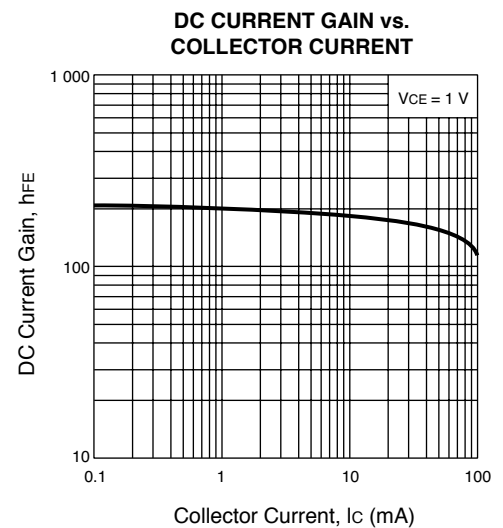
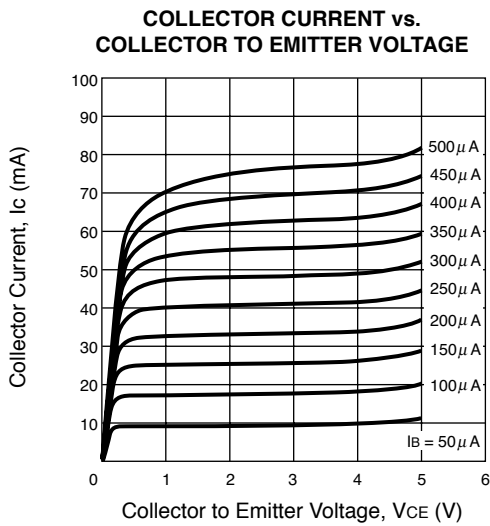
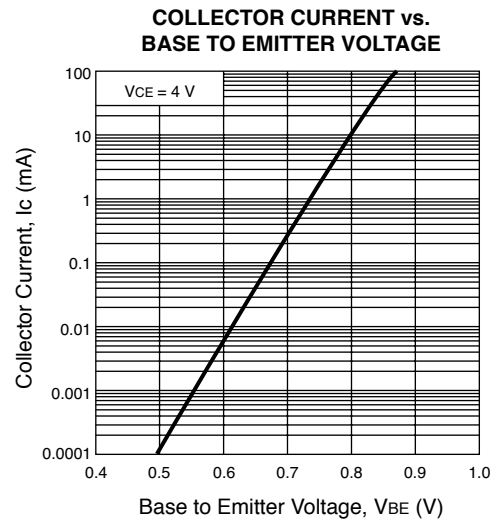
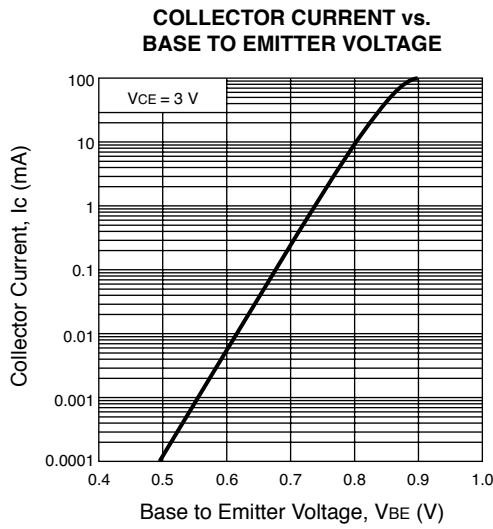

TYPICAL PERFORMANCE CURVES (T_A = 25°C)

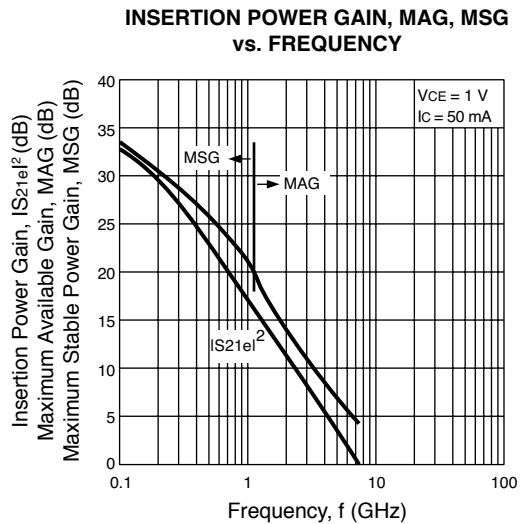
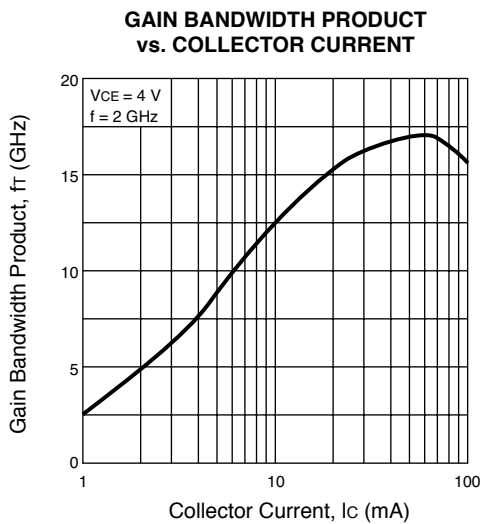
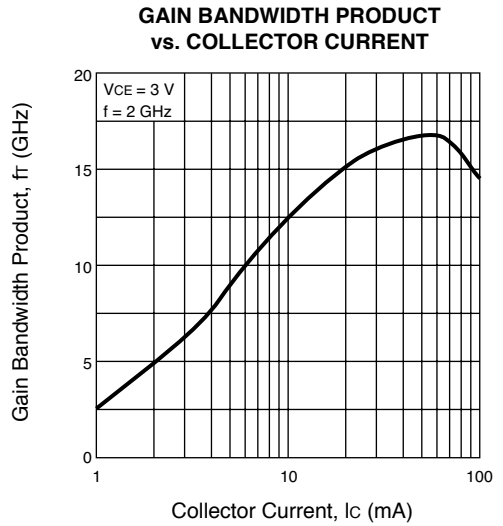
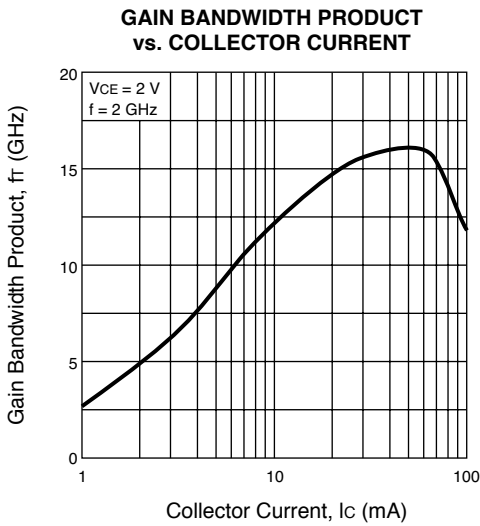
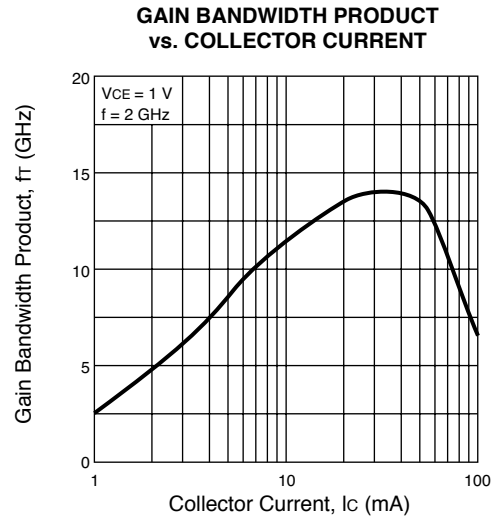
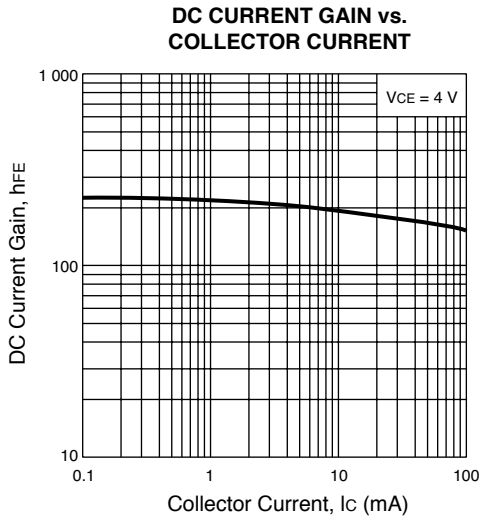

TYPICAL PERFORMANCE CURVES ($T_A = 25^\circ\text{C}$)

INSERTION POWER GAIN, MAG, MSG vs. FREQUENCY

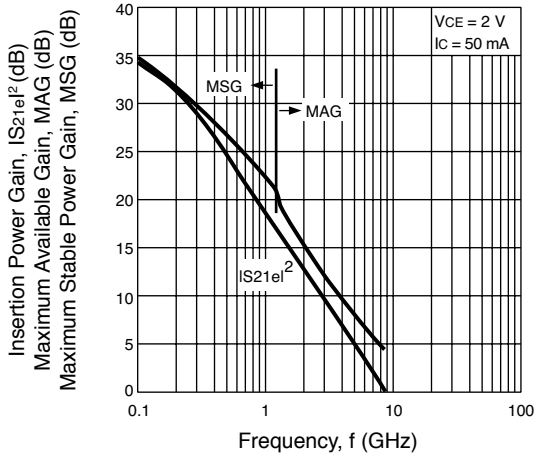

INSERTION POWER GAIN, MAG, MSG vs. FREQUENCY

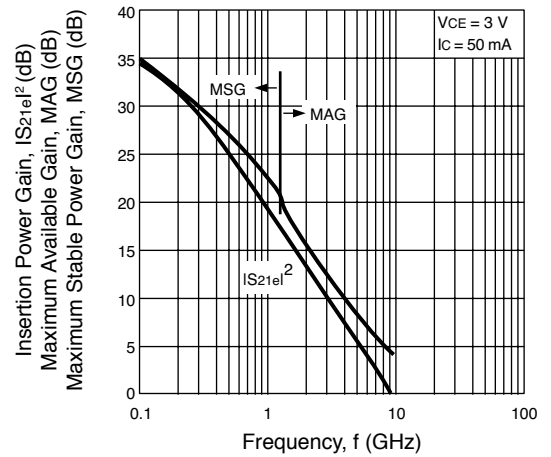

INSERTION POWER GAIN, MAG, MSG vs. FREQUENCY

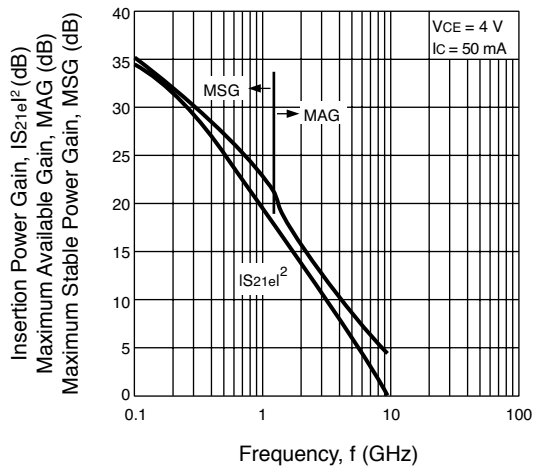

INSERTION POWER GAIN, MAG, MSG vs. COLLECTOR CURRENT

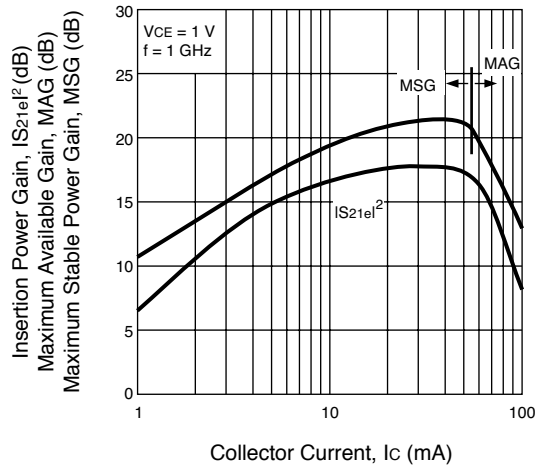

INSERTION POWER GAIN, MAG, MSG vs. COLLECTOR CURRENT

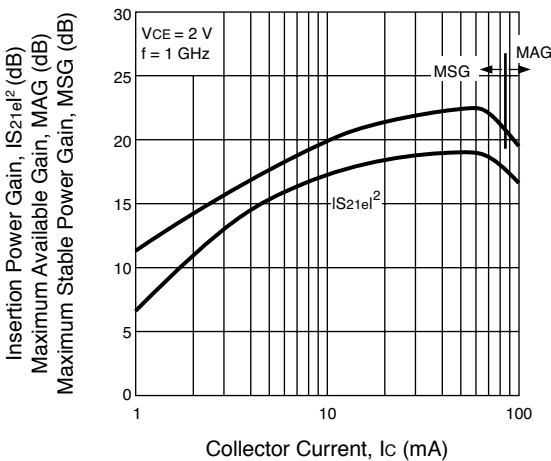

INSERTION POWER GAIN, MAG, MSG vs. COLLECTOR CURRENT

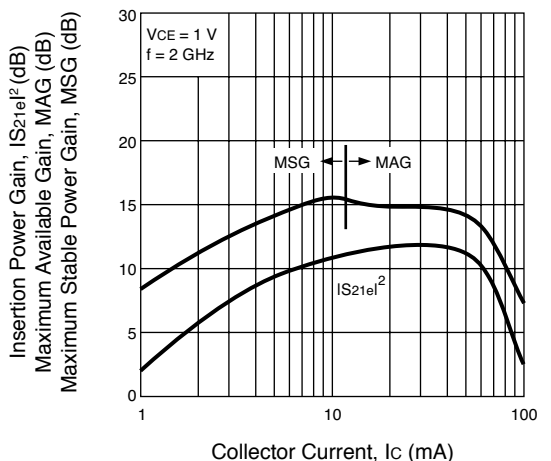

TYPICAL PERFORMANCE CURVES (TA = 25°C)

INSERTION POWER GAIN, MAG, MSG vs. COLLECTOR CURRENT

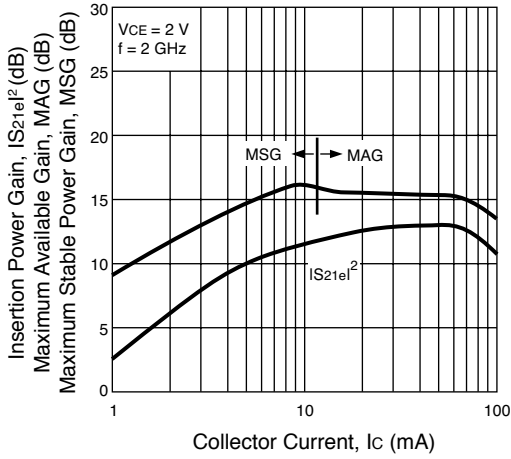

INSERTION POWER GAIN, MAG, MSG vs. COLLECTOR CURRENT

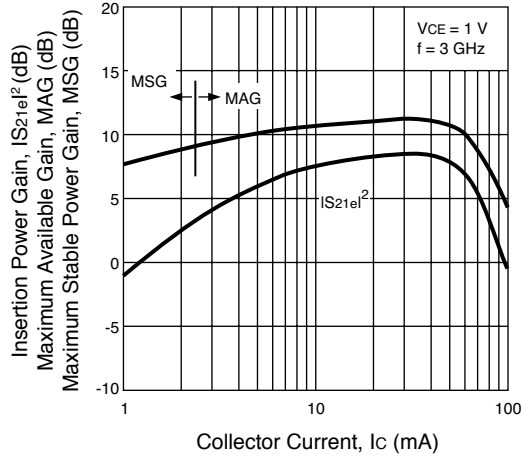

INSERTION POWER GAIN, MAG, MSG vs. COLLECTOR CURRENT

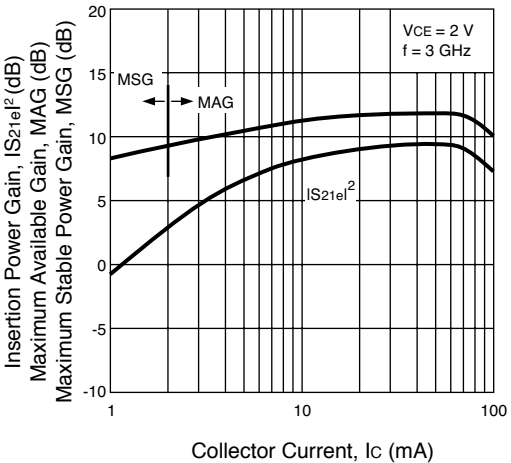

INSERTION POWER GAIN, MAG, MSG vs. COLLECTOR CURRENT

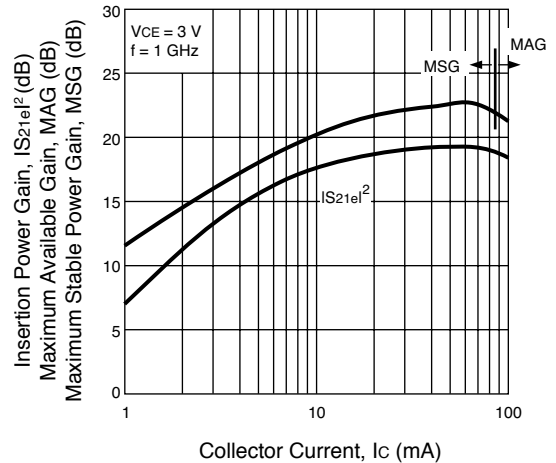

INSERTION POWER GAIN, MAG, MSG vs. COLLECTOR CURRENT

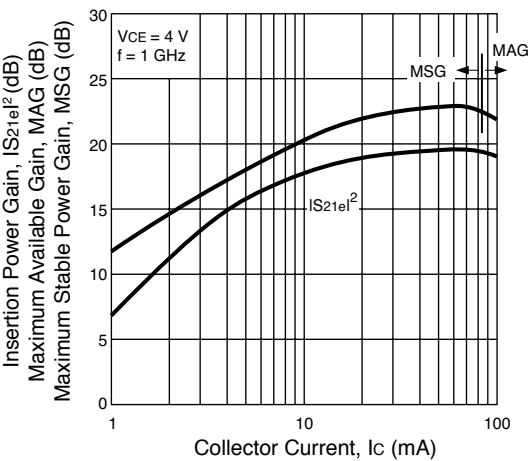

OUTPUT POWER, COLLECTOR CURRENT vs. INPUT POWER

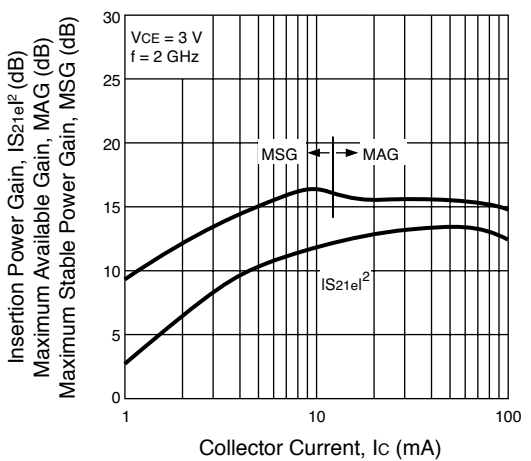

TYPICAL PERFORMANCE CURVES ($T_A = 25^\circ\text{C}$)

INSERTION POWER GAIN, MAG, MSG vs. COLLECTOR CURRENT

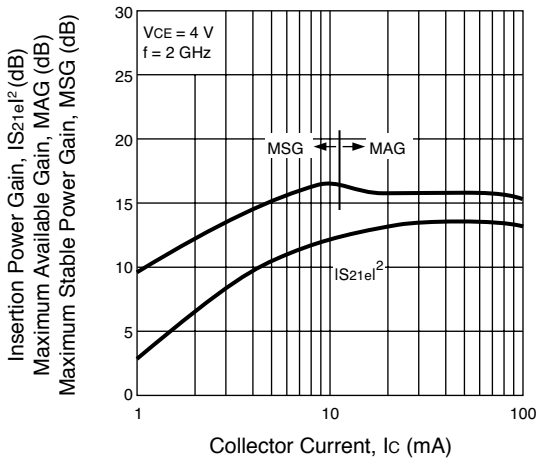

INSERTION POWER GAIN, MAG, MSG vs. COLLECTOR CURRENT

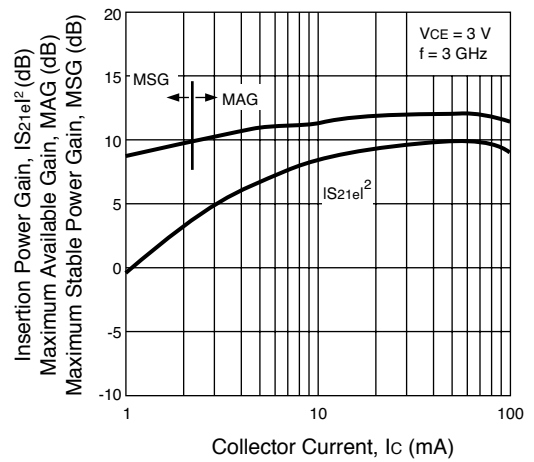

INSERTION POWER GAIN, MAG, MSG vs. COLLECTOR CURRENT

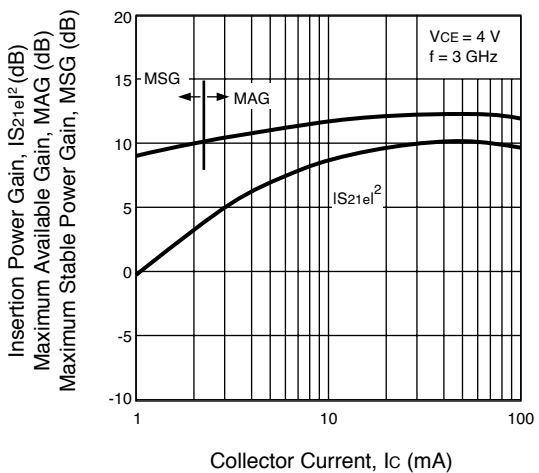

OUTPUT POWER, POWER GAIN, COLLECTOR CURRENT, COLLECTOR EFFICIENCY vs. INPUT POWER

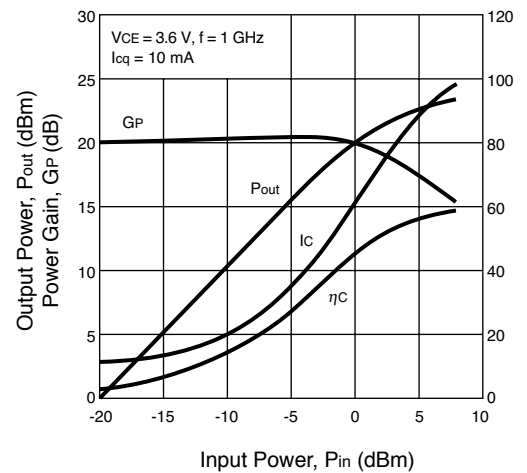

OUTPUT POWER, POWER GAIN, COLLECTOR CURRENT, COLLECTOR EFFICIENCY vs. INPUT POWER

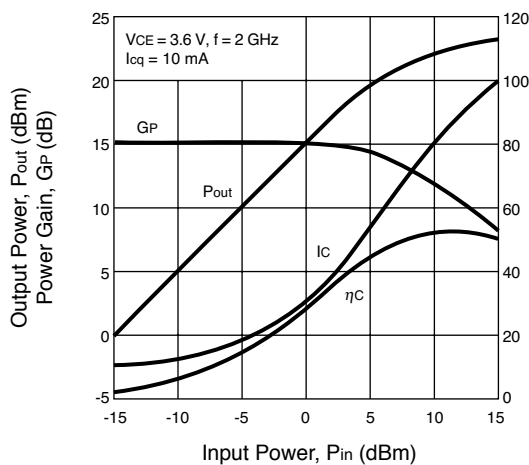

OUTPUT POWER, POWER GAIN, COLLECTOR CURRENT, COLLECTOR EFFICIENCY vs. INPUT POWER

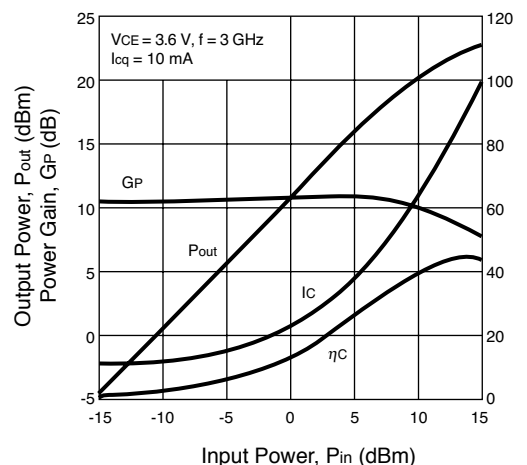

TYPICAL PERFORMANCE CURVES ($T_A = 25^\circ\text{C}$)

OUTPUT POWER, POWER GAIN, COLLECTOR CURRENT, COLLECTOR EFFICIENCY vs. INPUT POWER

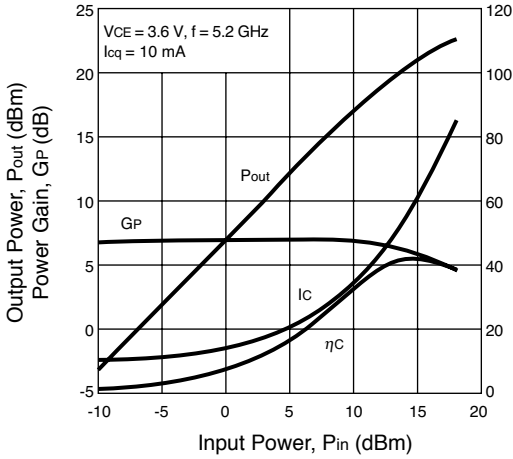

NOISE FIGURE, ASSOCIATED GAIN vs. COLLECTOR CURRENT

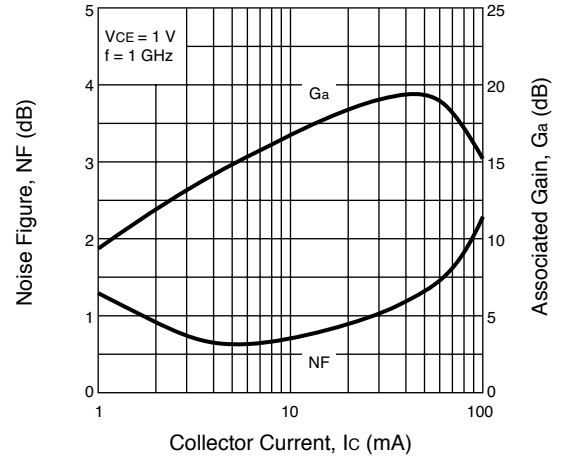

NOISE FIGURE, ASSOCIATED GAIN vs. COLLECTOR CURRENT

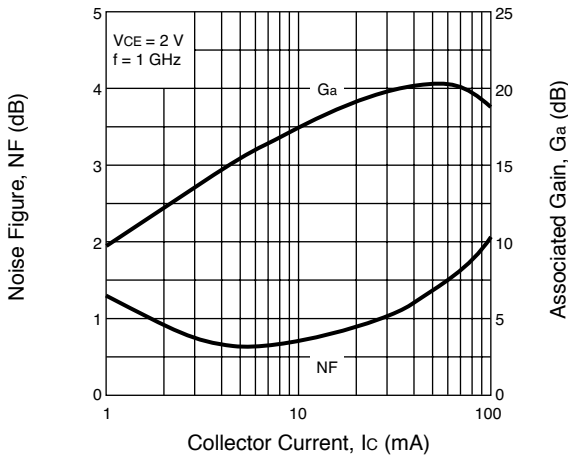

NOISE FIGURE, ASSOCIATED GAIN vs. COLLECTOR CURRENT

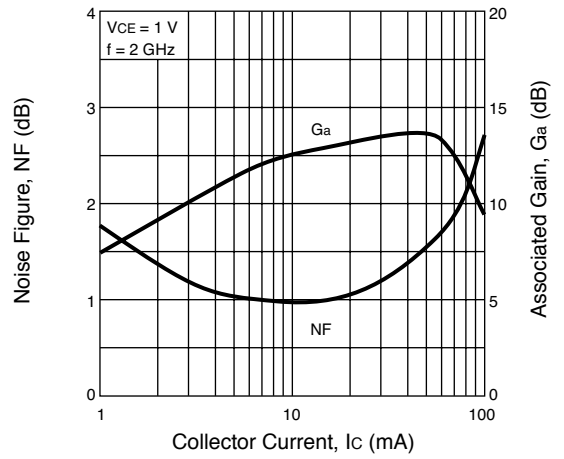

NOISE FIGURE, ASSOCIATED GAIN vs. COLLECTOR CURRENT

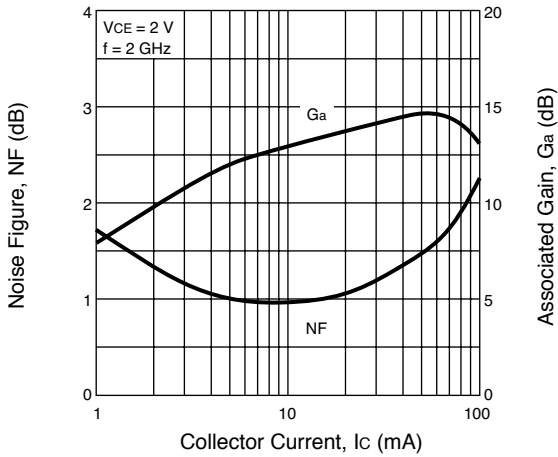

NOISE FIGURE, ASSOCIATED GAIN vs. COLLECTOR CURRENT

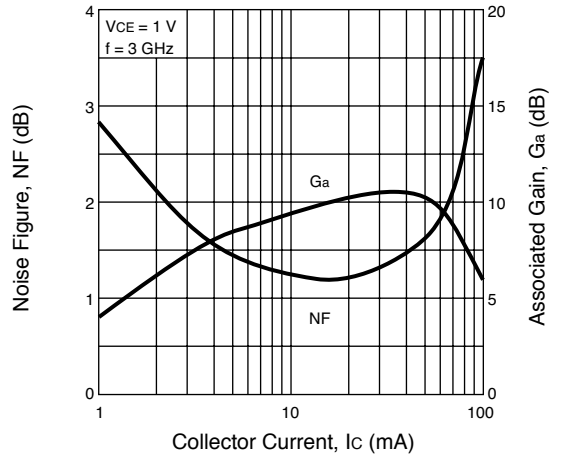

TYPICAL PERFORMANCE CURVES ($T_A = 25^\circ\text{C}$)

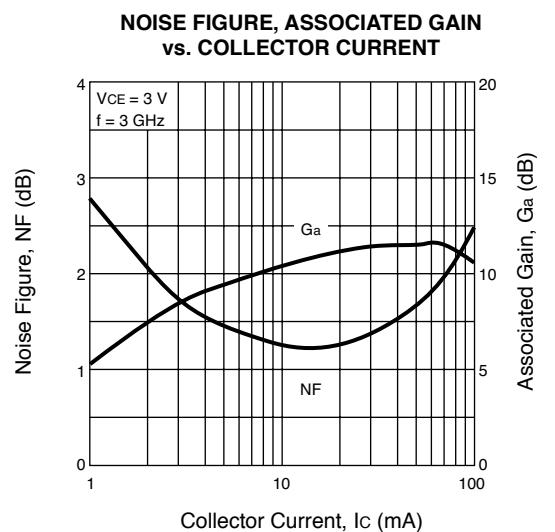
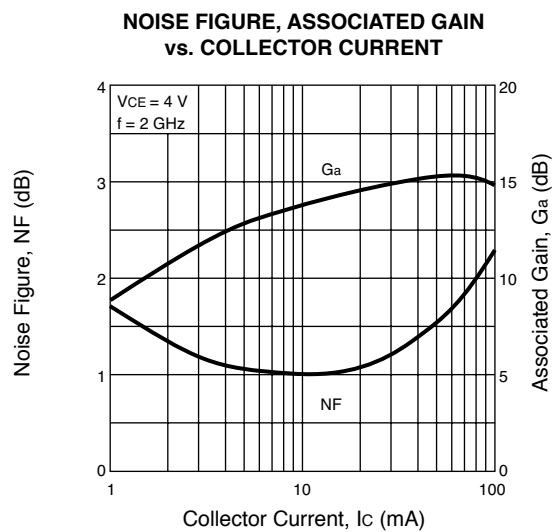
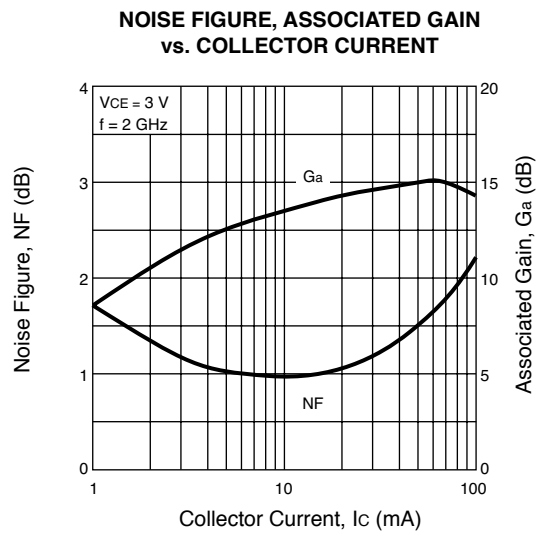
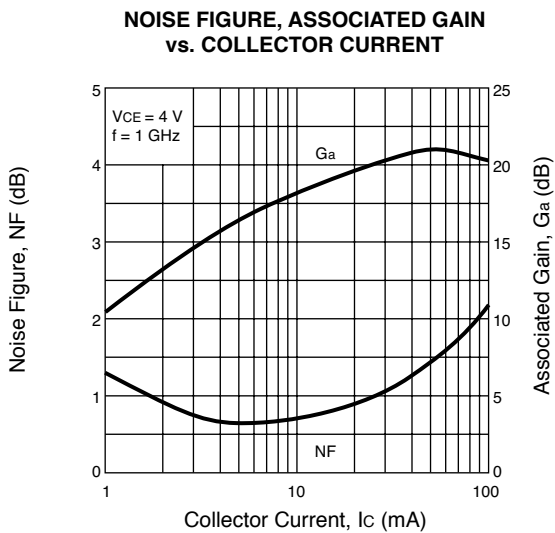
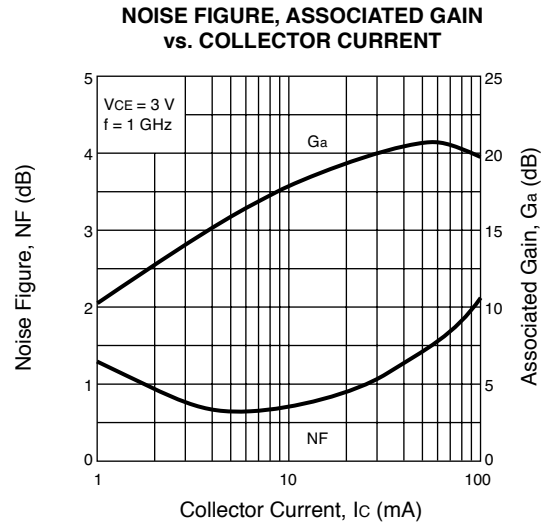
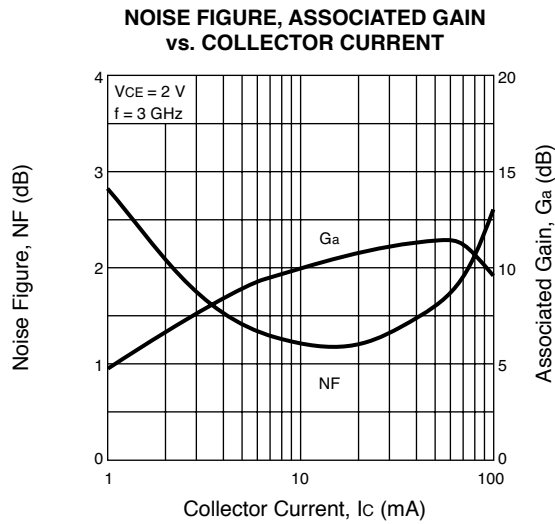

NESG2101M05

TYPICAL PERFORMANCE CURVES (TA = 25°C)

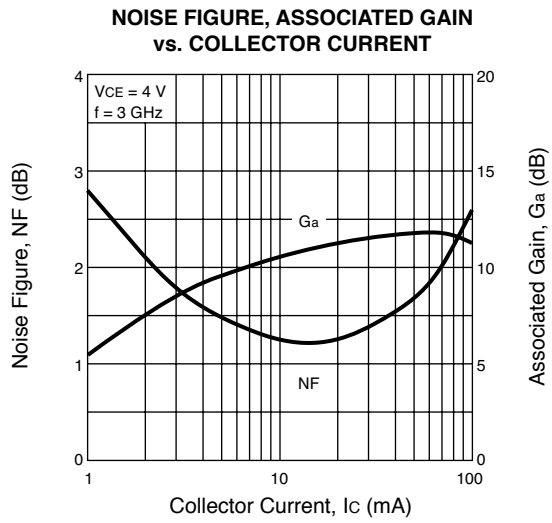

OUTLINE DIMENSIONS (Units in mm)

**PACKAGE OUTLINE M05
FLAT LEAD 4-PIN THIN TYPE SUPER MINIMOLD**

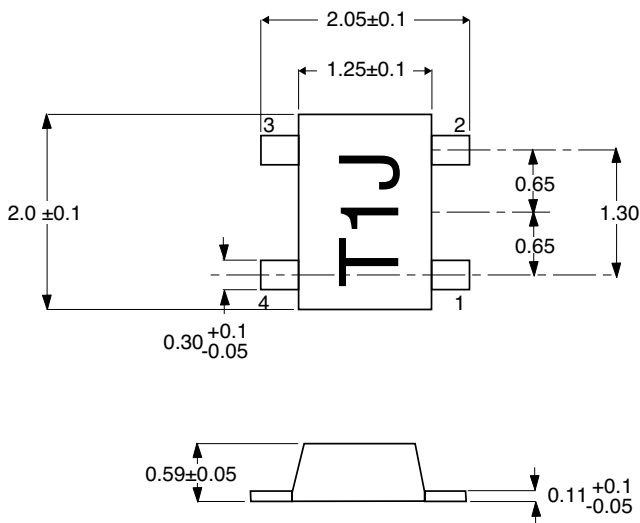
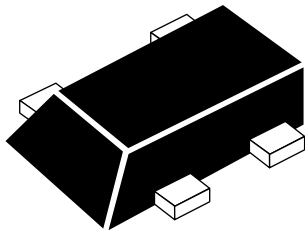

PIN CONNECTIONS

1. Base
2. Emitter
3. Collector
4. Emitter

TYPICAL SCATTERING PARAMETERS (TA = 25°C)

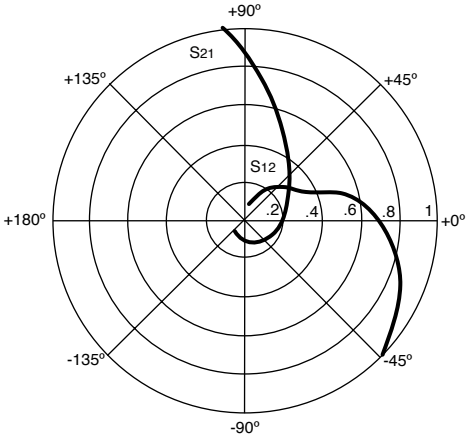
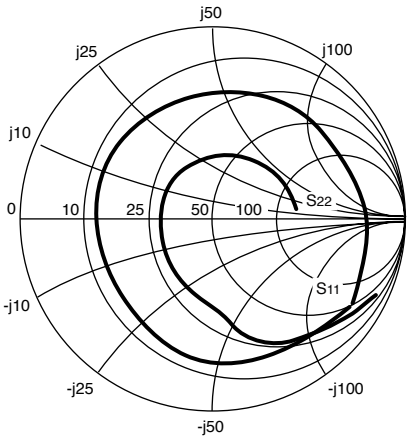

NESG2101M05
Vc = 2 V, Ic = 10 mA

FREQUENCY GHz	S11		S21		S12		S22		K	MAG ¹ (dB)
	MAG	ANG	MAG	ANG	MAG	ANG	MAG	ANG		
0.200	0.789	-60.55	22.546	143.21	0.038	57.24	0.827	-44.95	0.112	27.77
0.400	0.728	-101.35	16.859	119.77	0.055	40.53	0.640	-74.08	0.191	24.83
0.600	0.640	-126.85	12.438	105.88	0.061	32.65	0.469	-90.20	0.384	23.06
0.800	0.625	-144.45	9.872	95.71	0.066	28.51	0.394	-104.59	0.481	21.73
0.900	0.623	-151.37	8.927	91.52	0.068	27.07	0.370	-110.30	0.522	21.16
1.000	0.618	-157.17	8.141	87.71	0.070	25.95	0.349	-116.15	0.569	20.67
1.100	0.616	-162.79	7.468	84.22	0.072	25.14	0.332	-121.03	0.613	20.19
1.200	0.615	-167.45	6.893	80.93	0.073	24.39	0.320	-125.84	0.651	19.74
1.300	0.613	-171.88	6.401	77.88	0.075	23.86	0.308	-130.30	0.694	19.33
1.400	0.612	-176.14	5.971	74.92	0.076	23.41	0.300	-134.44	0.731	18.94
1.500	0.613	-179.93	5.595	72.08	0.078	22.92	0.292	-138.47	0.766	18.56
1.600	0.613	176.51	5.262	69.40	0.080	22.49	0.287	-142.03	0.797	18.19
1.700	0.612	173.28	4.969	66.77	0.081	22.12	0.282	-145.38	0.830	17.85
1.800	0.612	170.36	4.710	64.19	0.083	21.73	0.279	-148.48	0.856	17.52
1.900	0.612	167.10	4.470	61.72	0.085	21.34	0.276	-151.73	0.887	17.21
2.000	0.613	164.14	4.260	59.24	0.087	20.76	0.274	-154.58	0.910	16.91
2.100	0.613	161.30	4.067	56.96	0.089	20.30	0.272	-157.43	0.933	16.61
2.200	0.617	158.82	3.883	54.51	0.091	19.87	0.269	-159.83	0.948	16.31
2.300	0.616	155.93	3.723	52.25	0.092	19.47	0.268	-162.52	0.975	16.05
2.400	0.616	153.29	3.575	49.92	0.094	18.90	0.268	-164.76	0.995	15.79
2.500	0.618	150.71	3.437	47.73	0.096	18.25	0.268	-167.14	1.012	14.87
2.600	0.620	148.00	3.311	45.48	0.098	17.72	0.267	-169.01	1.025	14.31
2.700	0.618	145.67	3.195	43.27	0.100	17.10	0.268	-171.14	1.042	13.77
2.800	0.621	143.19	3.088	41.06	0.103	16.52	0.266	-172.97	1.053	13.38
2.900	0.621	140.77	2.983	38.89	0.104	15.93	0.267	-174.99	1.069	12.95
3.000	0.623	138.24	2.889	36.77	0.106	15.02	0.267	-176.60	1.079	12.63
3.200	0.626	133.27	2.718	32.52	0.111	13.69	0.268	-179.91	1.098	12.00
3.400	0.626	128.35	2.568	28.32	0.115	12.16	0.270	-177.06	1.118	11.41
3.600	0.630	123.52	2.436	24.16	0.119	10.49	0.270	-174.03	1.129	10.93
3.800	0.633	118.84	2.316	20.02	0.124	8.76	0.271	-171.13	1.139	10.46
4.000	0.637	113.84	2.209	15.92	0.128	6.86	0.273	-168.42	1.147	10.05
5.000	0.657	91.22	1.801	-4.45	0.149	-3.74	0.280	153.64	1.166	8.36
6.000	0.684	69.73	1.516	-24.91	0.168	-16.26	0.288	134.59	1.170	7.07
7.000	0.711	52.77	1.296	-43.46	0.183	-28.22	0.302	116.54	1.172	6.00
8.000	0.735	35.04	1.130	-61.62	0.195	-40.47	0.313	97.12	1.186	5.02

Note:

1. Gain Calculations:

$$MAG = \frac{|S_{21}|}{|S_{12}|} (K \sqrt{K^2 - 1}). \text{ When } K \leq 1, \text{ MAG is undefined and MSG values are used. } MSG = \frac{|S_{21}|}{|S_{12}|}, K = \frac{1 + |\Delta|^2 - |S_{11}|^2 - |S_{22}|^2}{2 |S_{12}| |S_{21}|}, \Delta = S_{11} S_{22} - S_{21} S_{12}$$

MAG = Maximum Available Gain
 MSG = Maximum Stable Gain

NESG2101M05

TYPICAL SCATTERING PARAMETERS (T_A = 25°C)

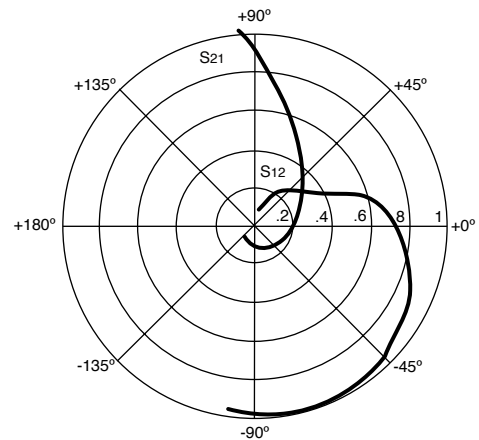
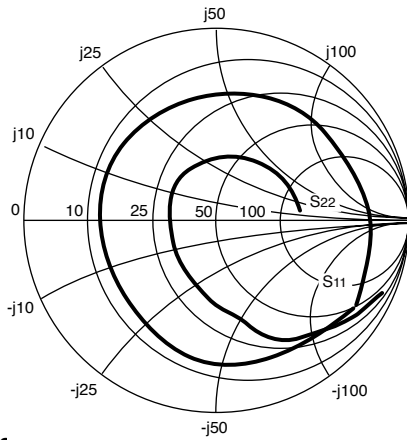

NESG2101M05
V_c = 3 V, I_c = 50 mA

FREQUENCY GHz	S ₁₁		S ₂₁		S ₁₂		S ₂₂		K	MAG ¹ (dB)
	MAG	ANG	MAG	ANG	MAG	ANG	MAG	ANG		
0.200	0.572	-113.11	40.843	122.65	0.022	47.89	0.622	-81.31	0.326	32.65
0.400	0.588	-146.82	24.097	102.66	0.029	43.32	0.465	-115.51	0.535	29.25
0.600	0.565	-164.47	16.568	93.61	0.034	45.52	0.366	-135.31	0.766	26.89
0.800	0.571	-174.66	12.645	86.36	0.040	47.14	0.344	-148.51	0.864	25.01
0.900	0.575	-178.62	11.301	83.26	0.043	47.40	0.338	-153.30	0.896	24.21
1.000	0.574	177.67	10.218	80.41	0.046	47.66	0.334	-157.83	0.929	23.47
1.100	0.578	174.15	9.319	77.77	0.049	47.88	0.331	-161.79	0.952	22.77
1.200	0.579	171.23	8.556	75.23	0.052	47.76	0.329	-165.34	0.972	22.13
1.300	0.580	168.24	7.916	72.83	0.056	47.49	0.327	-168.83	0.990	21.52
1.400	0.582	165.28	7.362	70.48	0.059	47.26	0.327	-171.79	1.005	20.55
1.500	0.584	162.68	6.879	68.16	0.062	46.69	0.327	-174.83	1.017	19.65
1.600	0.586	160.14	6.455	65.95	0.066	46.07	0.328	-177.28	1.026	18.95
1.700	0.585	157.81	6.087	63.80	0.069	45.35	0.328	-179.74	1.035	18.31
1.800	0.586	155.73	5.759	61.61	0.072	44.60	0.328	-177.91	1.041	17.76
1.900	0.586	153.15	5.462	59.51	0.076	43.97	0.329	175.52	1.051	17.21
2.000	0.588	150.78	5.196	57.39	0.079	42.87	0.330	173.57	1.056	16.75
2.100	0.590	148.53	4.960	55.46	0.082	41.96	0.330	171.41	1.059	16.31
2.200	0.594	146.68	4.730	53.32	0.086	40.87	0.329	169.50	1.060	15.93
2.300	0.593	144.30	4.533	51.36	0.089	39.88	0.331	167.46	1.067	15.49
2.400	0.593	142.02	4.351	49.30	0.092	38.91	0.331	165.70	1.071	15.11
2.500	0.595	139.86	4.182	47.40	0.095	37.77	0.334	163.93	1.075	14.75
2.600	0.598	137.53	4.025	45.40	0.098	36.70	0.333	162.52	1.076	14.44
2.700	0.596	135.56	3.883	43.42	0.102	35.46	0.335	160.76	1.080	14.09
2.800	0.598	133.38	3.750	41.47	0.105	34.20	0.334	159.24	1.080	13.80
2.900	0.599	131.30	3.623	39.50	0.108	33.05	0.335	157.55	1.083	13.48
3.000	0.601	128.98	3.510	37.60	0.111	31.78	0.335	156.19	1.084	13.22
3.200	0.604	124.58	3.300	33.78	0.118	29.38	0.336	153.36	1.087	12.68
3.400	0.604	120.05	3.118	29.94	0.124	26.78	0.338	150.81	1.090	12.17
3.600	0.608	115.64	2.957	26.15	0.130	24.08	0.337	148.07	1.089	11.75
3.800	0.609	111.42	2.812	22.38	0.136	21.31	0.339	145.42	1.090	11.31
4.000	0.613	106.64	2.684	18.56	0.142	18.59	0.340	142.94	1.090	10.93
5.000	0.630	85.56	2.191	-0.52	0.169	4.19	0.345	128.61	1.089	9.30
6.000	0.655	65.39	1.847	-20.04	0.191	-11.37	0.357	110.41	1.089	8.03
7.000	0.681	49.45	1.588	-37.86	0.208	-25.62	0.369	92.60	1.094	6.97
8.000	0.706	32.47	1.394	-55.46	0.219	-39.67	0.379	73.61	1.105	6.06

Note:

1. Gain Calculations:

$$MAG = \frac{|S_{21}|}{|S_{12}|} \left(K \sqrt{K^2 - 1} \right). \text{ When } K \leq 1, \text{ MAG is undefined and MSG values are used. } MSG = \frac{|S_{21}|}{|S_{12}|}, K = \frac{1 + |\Delta|^2 - |S_{11}|^2 - |S_{22}|^2}{2 |S_{12}| |S_{21}|}, \Delta = S_{11} S_{22} - S_{21} S_{12}$$

MAG = Maximum Available Gain

MSG = Maximum Stable Gain

TYPICAL SCATTERING PARAMETERS (T_A = 25°C)

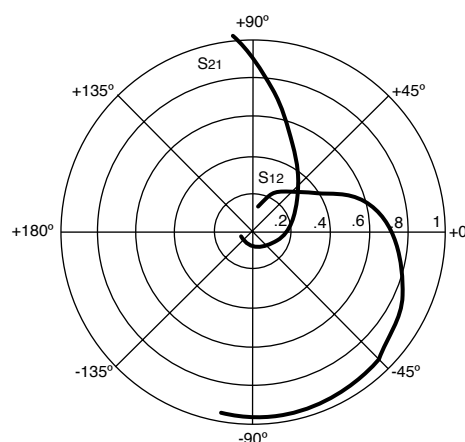
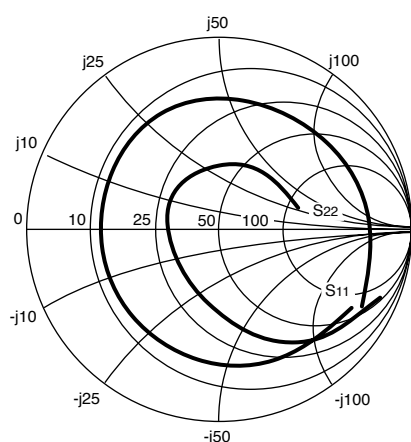

NESG2101M05
V_c = 3.6 V, I_c = 10 mA

FREQUENCY GHz	S ₁₁		S ₂₁		S ₁₂		S ₂₂		K	MAG ¹ (dB)
	MAG	ANG	MAG	ANG	MAG	ANG	MAG	ANG		
0.200	0.789	-57.89	22.895	144.36	0.036	58.70	0.837	-42.54	0.116	28.04
0.400	0.726	-98.15	17.340	121.13	0.053	42.11	0.649	-70.19	0.195	25.14
0.600	0.634	-123.23	12.889	106.94	0.059	34.42	0.476	-85.69	0.388	23.37
0.800	0.619	-141.61	10.285	96.59	0.064	30.25	0.397	-99.12	0.481	22.04
0.900	0.612	-148.55	9.304	92.38	0.066	29.03	0.369	-104.66	0.529	21.48
1.000	0.607	-154.90	8.480	88.48	0.068	27.89	0.345	-110.32	0.576	20.96
1.100	0.606	-160.48	7.794	84.91	0.070	27.18	0.328	-114.99	0.616	20.49
1.200	0.603	-165.23	7.205	81.64	0.071	26.60	0.313	-119.56	0.658	20.04
1.300	0.605	-169.91	6.687	78.44	0.073	25.96	0.301	-124.08	0.692	19.63
1.400	0.603	-173.86	6.244	75.51	0.075	25.57	0.291	-128.11	0.731	19.23
1.500	0.603	-177.86	5.852	72.66	0.076	25.20	0.283	-132.00	0.765	18.86
1.600	0.601	178.57	5.509	69.92	0.078	24.82	0.276	-135.75	0.800	18.51
1.700	0.603	175.17	5.203	67.24	0.079	24.50	0.270	-139.12	0.828	18.16
1.800	0.603	172.01	4.923	64.71	0.081	24.11	0.266	-142.52	0.858	17.82
1.900	0.602	168.75	4.677	62.23	0.083	23.81	0.262	-145.54	0.887	17.51
2.000	0.603	165.91	4.459	59.76	0.085	23.47	0.259	-148.55	0.911	17.21
2.100	0.605	162.98	4.256	57.44	0.086	23.03	0.257	-151.41	0.933	16.92
2.200	0.605	160.18	4.067	55.01	0.088	22.63	0.255	-154.00	0.956	16.63
2.300	0.605	157.54	3.898	52.69	0.090	22.17	0.253	-156.55	0.977	16.36
2.400	0.605	154.92	3.743	50.39	0.092	21.67	0.252	-158.93	0.996	16.09
2.500	0.606	152.29	3.600	48.17	0.094	21.18	0.252	-161.10	1.014	15.11
2.600	0.608	149.78	3.468	45.89	0.096	20.62	0.251	-163.46	1.028	14.56
2.700	0.607	147.22	3.345	43.72	0.098	20.15	0.251	-165.49	1.047	14.02
2.800	0.609	144.76	3.233	41.51	0.100	19.59	0.250	-167.54	1.060	13.61
2.900	0.610	142.18	3.127	39.34	0.102	19.01	0.250	-169.39	1.073	13.23
3.000	0.611	139.97	3.027	37.20	0.104	18.16	0.251	-171.29	1.084	12.89
3.200	0.613	134.84	2.849	32.93	0.108	16.95	0.251	-174.61	1.104	12.26
3.400	0.616	130.04	2.690	28.73	0.112	15.48	0.252	-177.81	1.122	11.69
3.600	0.617	125.12	2.552	24.58	0.116	13.94	0.253	-179.23	1.138	11.17
3.800	0.621	120.40	2.427	20.47	0.120	12.13	0.255	-176.30	1.146	10.73
4.000	0.624	115.57	2.315	16.31	0.124	10.28	0.256	-173.50	1.156	10.31
5.000	0.645	92.70	1.886	-4.08	0.144	-0.33	0.264	158.38	1.180	8.62
6.000	0.674	71.09	1.587	-24.60	0.161	-12.96	0.271	139.17	1.186	7.33
7.000	0.703	54.11	1.354	-43.38	0.174	-25.46	0.286	120.42	1.192	6.25
8.000	0.730	36.29	1.179	-61.88	0.185	-38.34	0.296	100.19	1.206	5.30

Note:

1. Gain Calculations:

$$MAG = \frac{|S_{21}|}{|S_{12}|} \left(K \sqrt{K^2 - 1} \right). \text{ When } K \leq 1, \text{ MAG is undefined and MSG values are used. } MSG = \frac{|S_{21}|}{|S_{12}|}, K = \frac{1 + |\Delta|^2 - |S_{11}|^2 - |S_{22}|^2}{2 |S_{12}| |S_{21}|}, \Delta = S_{11} S_{22} - S_{21} S_{12}$$

MAG = Maximum Available Gain

MSG = Maximum Stable Gain

NONLINEAR MODEL

SCHEMATIC

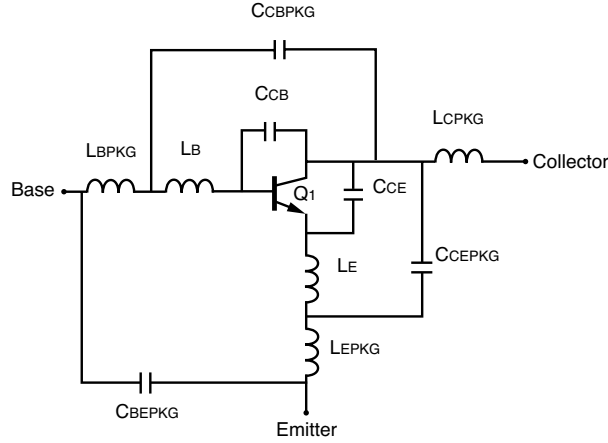

BJT NONLINEAR MODEL PARAMETERS⁽¹⁾

Parameters	Q1	Parameters	Q1
IS	3.64e-15	MJC	0.149
BF	309.7	XCJC	1
NF	1.079	CJS	0
VAF	56	VJS	0.75
IKF	233.9	MJS	0
ISE	11.67e-15	FC	0.8
NE	1.648	TF	4e-12
BR	20.01	XTF	10
NR	1.080	VTF	5
VAR	2.782	ITF	0.5
IKR	54.57e-3	PTF	20
ISC	1.024e-18	TR	0
NC	1.35	EG	1.11
RE	1.6	XTB	1.3
RB	2.2	XTI	5.2
RBM	0.05	KF	0
IRB	1e-4	AF	1
RC	4.8		
CJE	1.461e-12		
VJE	0.798		
MJE	0.137		
CJC	489.9e-15		
VJC	0.605		

(1) Gummel-Poon Model

Life Support Applications

These NEC products are not intended for use in life support devices, appliances, or systems where the malfunction of these products can reasonably be expected to result in personal injury. The customers of CEL using or selling these products for use in such applications do so at their own risk and agree to fully indemnify CEL for all damages resulting from such improper use or sale.

ADDITIONAL PARAMETERS

Parameters	NESG2101M05
CCB	0.01 pF
CCE	0.2 pF
LB	0.16 nH
LE	0.17 nH
CCBPKG	0.45 pF
CCEPKG	0.02 pF
CBEPKG	0.05 pF
LBPKG	0.8 nH
LCPKG	1.2 nH
LEPKG	0.15 nH

MODEL TEST CONDITIONS

Frequency: 0.1 to 6 GHz
 Bias: $V_{CE} = 2\text{ V}$, $I_C = 5\text{ mA}$ to 40 mA
 Date: 09/2003

Subject: Compliance with EU Directives

CEL certifies, to its knowledge, that semiconductor and laser products detailed below are compliant with the requirements of European Union (EU) Directive 2002/95/EC Restriction on Use of Hazardous Substances in electrical and electronic equipment (RoHS) and the requirements of EU Directive 2003/11/EC Restriction on Penta and Octa BDE.

CEL Pb-free products have the same base part number with a suffix added. The suffix –A indicates that the device is Pb-free. The –AZ suffix is used to designate devices containing Pb which are exempted from the requirement of RoHS directive (*). In all cases the devices have Pb-free terminals. All devices with these suffixes meet the requirements of the RoHS directive.

This status is based on CEL’s understanding of the EU Directives and knowledge of the materials that go into its products as of the date of disclosure of this information.

Restricted Substance per RoHS	Concentration Limit per RoHS (values are not yet fixed)	Concentration contained in CEL devices	
		-A	-AZ
Lead (Pb)	< 1000 PPM	Not Detected	(*)
Mercury	< 1000 PPM	Not Detected	
Cadmium	< 100 PPM	Not Detected	
Hexavalent Chromium	< 1000 PPM	Not Detected	
PBB	< 1000 PPM	Not Detected	
PBDE	< 1000 PPM	Not Detected	

If you should have any additional questions regarding our devices and compliance to environmental standards, please do not hesitate to contact your local representative.

Important Information and Disclaimer: Information provided by CEL on its website or in other communications concerning the substance content of its products represents knowledge and belief as of the date that it is provided. CEL bases its knowledge and belief on information provided by third parties and makes no representation or warranty as to the accuracy of such information. Efforts are underway to better integrate information from third parties. CEL has taken and continues to take reasonable steps to provide representative and accurate information but may not have conducted destructive testing or chemical analysis on incoming materials and chemicals. CEL and CEL suppliers consider certain information to be proprietary, and thus CAS numbers and other limited information may not be available for release.

In no event shall CEL’s liability arising out of such information exceed the total purchase price of the CEL part(s) at issue sold by CEL to customer on an annual basis.

See CEL Terms and Conditions for additional clarification of warranties and liability.