



# HIOKI

## 3156 LEAK CURRENT HiTESTER

Safety Standards  
Measuring Instruments



The Long-Awaited Bench-type Model Is Here !

## Leakage Current Measurement Essential for Electrical Safety

Because of the risks it poses, many standards stipulate leak current test methods, the performance of test equipment, limits for leak current, and other factors related to leak current. The bench-type 3156 LEAK CURRENT HiTESTER by itself, without any additional equipment, is capable of performing tests that comply with standards for a wide range of equipment, from general purpose electrical equipment to medical electrical equipment. The 3156 also is equipped with functions and an interface that support embedded test lines.



ISO14001  
JQA-E-90091



<http://www.hioki.co.jp/>

HIOKI company overview, new products, environmental considerations and other information are available on our website.

# Automatically compatible with Networks stipulated by IEC/UL/JIS standards

In order to avoid dangers such as electric shock, electrical equipment is designed so that those portions that are likely to be touched by people are insulated from the power source. However, the insulation resistance is not infinite, so there is always some leak current present. Furthermore, the extent of the leak current changes over time as the insulation deteriorates. To determine their safety level, the 3156 LEAK CURRENT HiTESTER can prove to be highly valuable, both as a tester on the production line as well as a maintenance and inspection tool.

## ■ Automatic measurement function

The 3156 is capable of automatically measuring power supply polarity switching as well as the normal state/single failure state, and can display the maximum values. The measurement time and the wait time can be set by the user.

## ■ Stores data for 100 units

The 3156 can store data such as equipment name, control number, ground class, and measured values for up to 100 pieces of equipment being tested.

## ■ Power supply separation

The power supply for the 3156 is separate from the line power supply of the equipment being tested, preventing damage to equipment due to wrong supply voltage being input.

## Main Features

### ■ Standard support for a variety of Networks

The 3156 is engineered to automatically support the "Networks" (human simulated resistance) stipulated by the various international safety standards. Switch between Networks or use the filters using a PC.

### ■ Measurement that complies with standards

The 3156 by itself can measure leak current in compliance with IEC, UL, and JIS standards.

### ■ RS-232C, GP-IB, and EXT I/O interfaces standard

Because the 3156 is equipped with several standard interfaces, it is easy to set up for automatic inspection on a production line, etc. In addition, the RS-232C port can be used to connect the optional 9442 Printer for easy print-outs.

### ■ Save up to 30 sets of measuring conditions

The 3156 can save and load up to 30 different sets of measuring conditions, and can switch between different sets quickly.

### Simple operation in an interactive format

The 3156 is equipped with a touch panel that can be used to make settings simply by touching the items to be selected on the display, making operation even more simple.

### 110% voltage application terminals

The 110% voltage application terminals are used when testing medical equipment. It outputs on a 1:1 basis the voltage that is supplied to the line power supply for the equipment being tested. The polarity of the connectors can be switched.

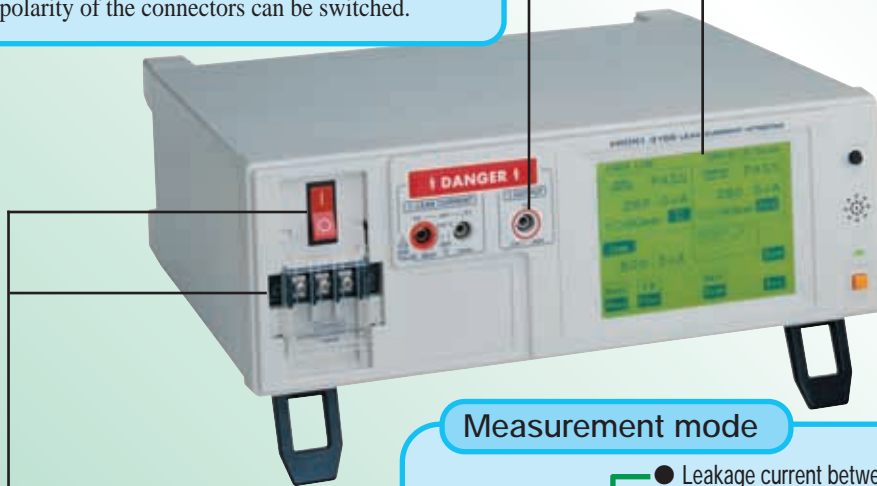

### Breaker for equipment being tested

Since the 3156 is a bench-type unit that is suited embedded test lines, it is equipped with a terminal board and breaker on the front panel, allowing test equipment to be easily connected to the 3156 even when it is rack mounted.

### Measurement mode

General equipment

- Leakage current between enclosure and line
- Leakage current between enclosure and earth
- Leakage current between enclosure and enclosure
- Earth leakage current

Medical equipment

- Patient leakage current I
- Patient leakage current II
- Patient leakage current III
- Patient auxiliary current

Based on the settings for the Network and the equipment being tested, the 3156 displays the appropriate measurement mode. The state of the settable keys can be seen at a glance. All settings can be made by selecting the appropriate items or values.

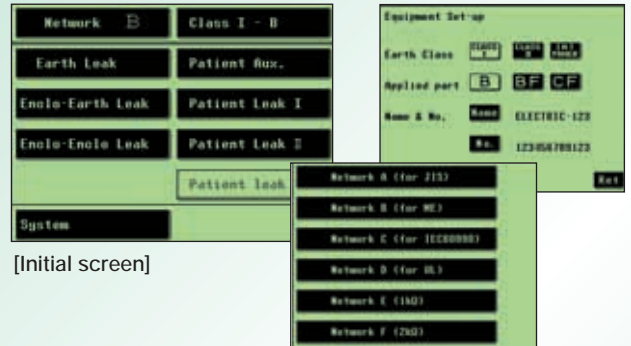

[Initial screen]

**Wiring check functions**

The 3156 performs polarity checks and VA checks.

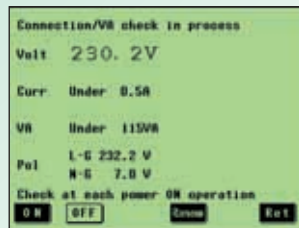

[System screen]

**Support for proprietary networks**

When making measurements on a proprietary network that is not built into the 3156, the 3156 can be used as a true effective value ammeter in the 1MHz band.

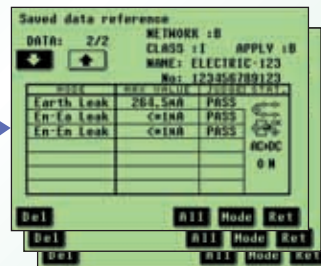

**Browsing saved data**

The 3156 allows the user to browse all saved data. Saved data can also be printed out or downloaded to a computer.

**Maximum value display**

Displays the power supply failure status and the maximum value for the leak current as it fluctuates due to the operation of the equipment being tested.

Power supply polarity/equipment status/measured current

**Allowable value**

The upper limit for tolerance is set according to the standard. The set value can be changed freely, if necessary.



[Measurement screen]

Result of evaluation against tolerance setting

Current measured value

**Data storage**

Measurement data: For up to 100 units  
Measuring conditions: Up to 30 sets

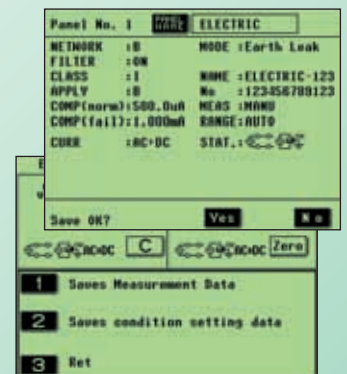

**Single failure setting**

The single failure status can be set for individual items in automatic testing, with continuous testing performed automatically only for the items for which the single failure setting was made. In addition, the wait time and measurement time can also be set.

# Leak current measurement for general equipment

The network (human simulated resistance) is specified separately in each standard, and when taking measurements a network that is suited to the standards is needed. The 3156 is pre-engineered with basic Networks that correspond to each standard.

## IEC standard

[ IEC 60990, others ]

## UL standard

[ UL471, UL1310, UL1437, others ]

## JIS standard

[ JIS B8561, others ]

The standard numbers that are listed are only examples. The networks listed below can be used with all applicable standards.

### Network types

#### For JIS standards

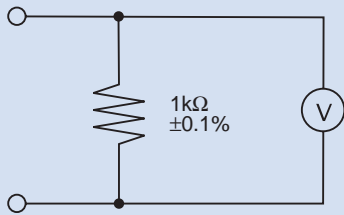

Basic measuring element

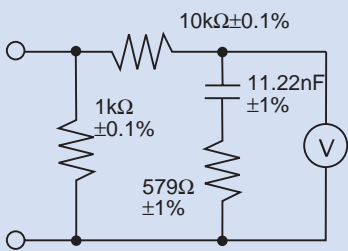

Filter on

#### For IEC60990s

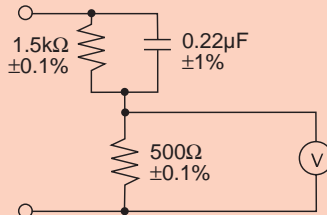

Basic measuring element

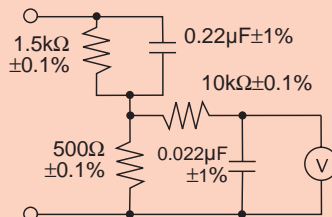

Filter 1 on

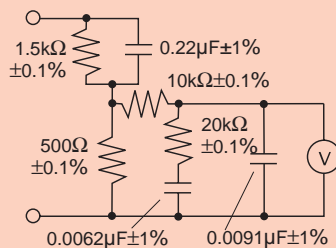

Filter 2 on

#### For UL standards

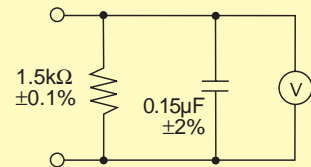

Basic measuring element

#### General purpose 1

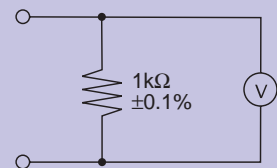

Basic measuring element

#### General purpose 2

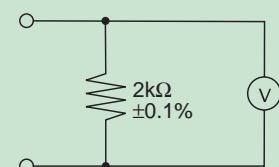

Basic measuring element



# Leak current measurement for medical equipment

Medical equipment leak current includes not only ground leak current and exterior leak current, but also patient leak current (I to III) and patient measured current. The 3156 can measure all of these different types of leak current without any additional equipment.

## IEC standard

[ IEC 60601-1 ('88) + am1 ('91) + am2 ('95) ]

## UL standard

[ UL 2601-1, others ]

## JIS standard

[ JIS T 0601-1, others ]

The 3156 does not have a built-in insulated transformer. When measuring

medical equipment, use a step-up insulated transformer or other device to provide 110% of the rated voltage as the line power supply for the equipment being tested.

The standard numbers that are listed are only examples. The

## Leak current types and Network types

### Medical equipment leak current types

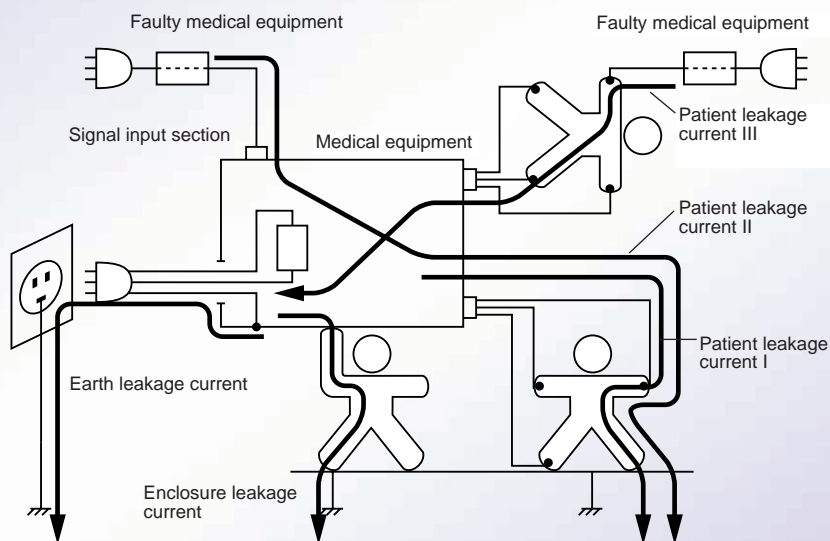

#### Earth leakage current

A current flowing from the power supply through the interior or surface of the insulation to the protective ground line.

#### Enclosure leakage current

A current flowing from a part of the enclosure which during normal use can be touched by an operator or patient either to ground or to another part of the enclosure, through an external conductor other than the protective ground.

#### Patient leakage current

A current flowing from the device through the patient to ground.

#### Patient auxiliary current

A current flowing between contacts which during normal use are connected through the patient, with no intended physiological effect.

### For medical equipment

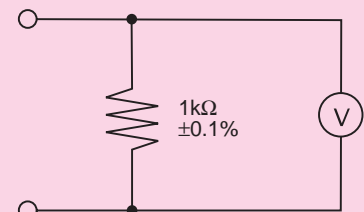

Basic measuring element

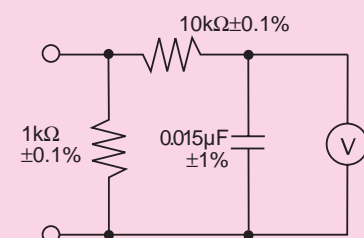

Filter on



### Separation of the power supply for the 3156 and the line for the equipment being tested

The power supply voltage for the 3156 does not need to be changed, even if the supply voltage for the equipment being tested is different. The difference can be managed by controlling the line supply voltage for the equipment being tested. This helps prevent malfunctions due to the wrong voltage being input for the 3156 power supply.

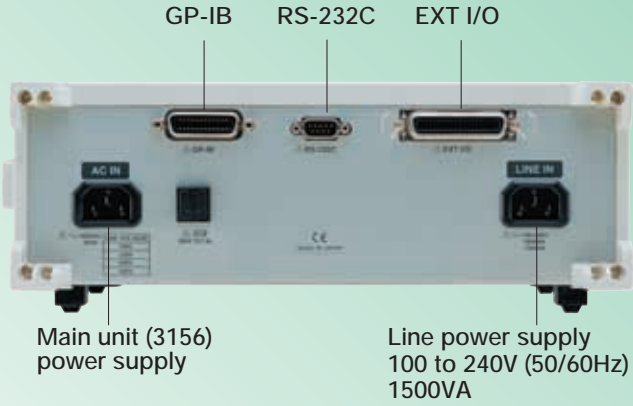

### External control through EXT I/O

The start of measurement and the loading of the measuring conditions can be controlled externally. The evaluation results, test signals, etc., can also be output externally, permitting the construction of an automated line.

Input signal	Active low signal
Maximum applied voltage	Voltage input to the EXT.DCV terminal
High level	Voltage input to the EXT.DCV terminal, or open
Low level	0.3V DC or less
Output signal	Open collector output
Maximum load voltage	24V DC (when not using the EXT.DCV terminal)
Maximum output current	60mA DC per signal (when low level)

In addition to outputting evaluation results for each measurement item, the T-FAIL output is provided for continued output after one FAIL during automatic testing.

Contents of EXT I/O	
<b>● Outputs</b>	
TEST	: Continues to output a low signal during automatic measurement
MEAS	: Outputs the count when measuring multiple items during automatic measurement
PASS	: Outputs the evaluation result "PASS" for individual items during automatic measurement
FAIL	: Outputs the evaluation result "FAIL" for individual items during automatic measurement
T-FAIL	: Continues output even if a FAIL occurs during automatic testing.
NT.DCV	: Internal 5V DC output (not insulated from internal circuitry)
INT.GND	: Internal GND output (identical to rack grounded GND level)
<b>● Inputs</b>	
START	: Starts automatic measurement when low
STOP	: Forcibly ends measurement when low
LOAD (0 to 4)	: Loads a saved panel (30 panels)
0ADJ	: Zero adjust signal (valid only in ground leak current mode)
EXT.DCV	: External power supply input (5V to 24V DC)
EXT.COM	: External COM input

### External control through a PC

Includes RS-232C interface and GP-IB interface as standard. These can be used to control the functions of the 3156 through a PC, and to collect measurement values.

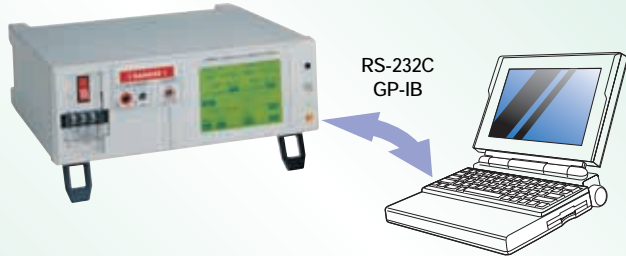

**■ RS-232C interface**  
 Transfer method: Start-stop synchronization, full-duplex  
 Transfer speed : 9600 fixed  
 Data length : 8 bits  
 Stop bit : 1  
 Parity bit : None  
 Delimiter : CR+LF  
 Handshaking : None  
 XON/XOFF : Not used  
 Connector : D-sub 9-pin male

**■ GP-IB interface**  
 Compliant standards: IEEE-488.1 1987,  
 Refer to IEEE-488.2 1987  
 Connector : D-sub 24 pin female

### Data printout

Data can be printed out on the optional 9442 Printer by using the RS-232C interface connector. This is useful for attaching inspection data, etc.



Printing method: Thermal serial dot printing  
 Paper width/printing speed: 112 mm/52.5cps  
 Power supply: 9443 AC Adapter, or NiMH battery provided (charge with the 9443; can print approximately 3000 characters with a full charge)  
 Dimensions: Approx. 160(W)×66.5(H)×170 (D) mm  
 Mass: Approx. 580g

\* Connecting the 9442 requires either the 9444 Connecting Cable or the AC adapter.

Printout contents	
(The printed items can be selected from among the items listed below.)	
● Measurement date	● Maximum value
● Equipment name	● Evaluation result
● Control number	● Measured current (AC, DC, AC+DC, AC peak)
● Class (mounting section)	● Power supply polarity (normal phase, reverse phase)
● Network	● Equipment status (normal, not grounded)
● Measurement mode	
● Filter setting	
● Tolerance	

## 3156 Specifications

### ■ Leak current measurement

Measurement mode	: Earth leakage current / Leakage current between enclosure and earth / Leakage current between enclosure and enclosure / Leakage current between enclosure and line / Patient leakage current I / Patient leakage current II / Patient leakage current III / Patient auxiliary current
Target current	: DC, AC, AC+DC, AC peak
Allowable value measurement current	: 25 mA max. (DC/AC/AC+DC mode) 75 mA max. (ACpeak mode)
Measurement range	: DC/AC/AC+DC mode: 50 $\mu$ A/500 $\mu$ A/5 mA/25 mA AC peak mode: 500 $\mu$ A/1 mA /10 mA/75 mA
Range switch	: Auto range/Hold range
Trigger system	: Manual: Automatic generation of internal trigger, and free-run measurement Automatic: measurement started by external start signal 1. Started by pressing Start key on the operation screen. 2. Asserted by the START terminal on the EXT I/O connector. 3. Started by the :START interface command.
Measurement speed	: Trigger-system manual measurement: 100 $\pm$ 1 ms (indication of moving average of 16 measurements) Trigger-system automatic measurement: 100 $\pm$ 1 ms (min.) - measurement setting time
Measurement terminals	: Terminal T1, terminal T2 (with built-in fuse holder) Terminal T3 (110% voltage application terminal)

### ■ Functions

110% voltage application function	: Equipped with a voltage output terminal (T3) that applies 110% power supply voltage between the functionally insulated signal input/output section (or Type F applied part) and ground. Output ON/OFF selection Output impedance: 22.5 $\pm$ 1 k $\Omega$ •Applied when positive phase (to input power supply voltage) •Applied when negative phase (to input power supply voltage) Automatic switching function (automatic measurement function)
Wiring check function	: Polarity check/VA check
Automatic measurement function	: Setting of measuring time. Setting of delay (wait) time for changing setting conditions. The power supply polarity and equipment status are automatically switched during measurement.
Application line selection function	: Use of T2 and internal contact/Use of T1 and T2
Ground fault prevention function	: Pre-check of current value between connection terminals to prevent a ground fault. Only effective for leakage current measurement between enclosure and line.
Setting of single-fault condition	: •Setting of malfunction mode for power line for sample equipment. 1. Disconnection of one wire in power line (neutral side) 2. Disconnection of protective earth conductor •Application of 110% voltage for simulated connection of malfunctioning equipment. Positive phase/negative phase •Selection of application line for leakage current measurement between enclosure and line.
Power line for sample equipment (switching power supply polarity)	: Positive/negative phase (Automatic switching possible when using automatic measurement function)
Setting of measuring time	: Setting range: 1 sec. to 5 min., in 1-sec. increments Effective only in automatic measurement
Measurement delay (setting) function	: Setting range: 1 sec. to 30 min., in 1-sec. increments •Wait time from the completion of measurement to power supply disconnection •Wait time from switching power supply polarity to the start of measurement •Wait time for operations other than switching polarity
Maximum value hold function	: Effective in all measurement modes

Measurement system	: Indication of a current value calculated based the measured drop in voltage caused by simulated resistance of the human body. Measurement of true effective value. The measurement section: chassis-grounded and floating.
A/D conversion system	: $\Delta \Sigma$ system (20 bits)
Input resistance	: 1 M $\Omega$ $\pm$ 1% (single-ended input) Excluding voltmeter section, simulated resistance of the human body (current detection circuit)
Input capacity	: 200 pF or lower (between terminals T1 and T2) (f = 100 kHz, with network circuit isolated)
Grounding capacity	: 200 pF or lower (between terminals T1/T2 and chassis)
CMRR (between terminals T1/T2 and chassis)	: 60 dB or higher, at 60 Hz, 10 kHz 40 dB or higher, at 100 kHz, 1 MHz

### ■ Network (human simulated resistance)

● For medical electrical equipment	: Basic measurement element: 1 k $\Omega$ Filter: 10 k $\Omega$ + 15 nF
● For IEC 60990	: Basic measurement element: 1.5 k $\Omega$ + 500 $\Omega$ Filter 1: 10 k $\Omega$ + 22 nF Filter 2: 10 k $\Omega$ + (20 k $\Omega$ + 6.2 nF) // 9.1 nF
● For JIS	: Basic measurement element: 1 k $\Omega$ Filter: 10 k $\Omega$ + 11.22 nF + 579 $\Omega$
● For UL	: Basic measurement element: 1.5 k $\Omega$ // 0.15 $\mu$ F
● General-purpose 1:	Basic measurement element : 1 k $\Omega$
● General-purpose 2:	Basic measurement element : 2 k $\Omega$

Allowable value judgement function	: Allowable value: Sets the upper-limit current value Judgement: PASS measurement value $\leq$ upper-limit value FAIL measurement value $>$ upper-limit value Processing: Indication, buzzer, judgement output from EXT I/O
Mode selection function	: •Current measurement function Unit of current measurement: Auto/ mA, fixed •Voltage measurement function Isolates the internal network for using the product as a voltmeter between terminals T1 and T2. Maximum measurement voltage: 25 V
Beep sound setting	: •Allowable value judgement •Key input •T3 (110% voltage application terminal) output •Line voltage output from T2
Save/load function	: 30 panels for saving the following setting data (measurement mode, network, equipment name, control number, grounding class, applied part, measurement range, filter, target current, allowable value setting, malfunction condition setting, power supply polarity switching, automatic measurement items, automatic measuring time, measurement delay time)
Data save function	: Saved content: Sample equipment information (equipment name, control number), measurement data, date Memory capacity: Data on up to 100 units
Clock function	: Auto calendar, automatic leap-year adjustment, 24-hour clock Clock accuracy: Deviation of about 4 minutes a month
Data backup function	: SRAM (test condition data), RTC Backup battery life: 4 years (reference value at 25°C)
Backlight automatic OFF function	: Constant ON/Auto OFF 1 min. to 30 min., in 1-min. increments
Self-test function	: MEM (internal RAM)/KEY (6 $\times$ 6 matrix touch panel)/LCD (front LCD panel)/LED /Buzzer
Language setting	: Japanese or English
System reset	: Clears all data including measurement conditions and measurement data. Clears all saved measurement data. Clears all saved condition setting data including panels.

## ■ Accuracy (Current measurement)

- Operating temperature and humidity for guaranteed accuracy: 23 ± 5 °C, 80%rh or lower (no condensation)
- Temperature coefficient: 0.1 x basic accuracy x (T-23) weighted --- operating temperature T (°C)
- Warm-up time: 30 min.
- Value calculated based on voltage detected at terminals of Network having non-inductive resistance of 1 kΩ (theoretical value).
- Measurements in voltmeter mode conform to the following accuracy level.

## ● Measurement of AC\*1, AC+DC

Range	Guaranteed accuracy range	Measurement resolution	Accuracy	
			DC < f ≤ 100kHz	100kHz < f ≤ 1MHz
25.00 mA	4 mA or more	10 μA	±(2.0%rdg.+6dgt.)	±(2.0%rdg.+10dgt.)
5.000 mA	400 μA or more	1 μA		
500.0 μA	40 μA or more	0.1 μA	±2.0%f.s.	±2.0%f.s.
50.00 μA	4 μA or more	0.01 μA		

## ● Measurement of AC Peak\*2

Range	Guaranteed accuracy range	Measurement resolution	Accuracy	
			20Hz < f ≤ 1kHz	1kHz < f ≤ 10kHz
75.0 mA	8mA or more	100 μA	±(2.0%rdg.+2dgt.)	±(5.0%rdg.+10dgt.)
10.00 mA	0.8mA or more	10 μA		
1.000 mA	100 μA or more	1 μA	±2.5%f.s.	±5.0%f.s.
500.0 μA	40 μA or more	0.1 μA		

## ● Measurement of DC

Range	Guaranteed accuracy range	Measurement resolution	Accuracy
25.00 mA	4 mA or more	10 μA	±(0.2%rdg.+3dgt.)
5.000 mA	400 μA or more	1 μA	
500.0 μA	40 μA or more	0.1 μA	±1.0%f.s.
50.00 μA	4 μA or more	0.01 μA	

## ● Power supply voltage monitor accuracy

Range	Guaranteed accuracy range	Measurement resolution	Accuracy
300.0 V	85 V or more*3	0.1 V	±(2.0%rdg.+10dgt.)

## ● Current consumption monitor accuracy (measurement method: average value response, effective value conversion)

Range	Guaranteed accuracy range	Measurement resolution	Accuracy
16 A	0.5A or more*4	0.1 A	±(2.0%rdg.+5dgt.)

\*1: Weighted with frequency characteristic (fc = 4 Hz) of high-pass filter.

\*2: Cannot be set when network A, B and C(filter off) is selected.

\*3: "less than 80 V" is indicated for a value less than 80 V.

\*4: "less than 0.5 A" is indicated for a value less than 0.5 A.

## ■ General Specifications

Display section : 320 × 240 dot matrix LCD (with backlight)

Operation section : 6 × 6 matrix touch panel

Operating temperature : 0 to 40 °C, 80%rh or less (no condensation) and humidity

Storage temperature : -10 to 50 °C, 80%rh or less (no condensation) and humidity

Recommended : 6 months

Calibration Period

Operating Environment : Indoors, <2000 m ASL

Power source for main unit : 100, 120, 220, 240 VAC (default setting)

Rated power source frequency: 50/60 Hz

Rated power: 30 VA

Power line for sample : 100 to 240 VAC

equipment and power output : Rated power source frequency: 50/60 Hz

Rated power: 1,500 VA

Power output maximum : 25 mA

allowable leakage current : Withstand voltage : [All power supply terminals] - [Protective earthing]

1.35 kV AC (5 mA), 1 min.

[All measurement terminals] - [All power supply terminals]

2.30 kV AC (5 mA), 1 min

[All measurement terminals] - [Control circuit]

2.30 kV AC (5 mA), 1 min

Applicable Standards : EMC: EN61326:1997+A1:1998+A2:2001

EN61000-3-2:2000

EN61000-3-3:1995+A1:2001

Safety: EN61010-1:2001

EN61010-2-031:1994 Pollution Degree 2

Terminals T1, T2: Measurement category II

(Anticipated Transient Overvoltage: 2.5 kV)

Terminal T3: Measurement category I

(Anticipated Transient Overvoltage: 1.5 kV)

Effect of conducted radio-frequency electromagnetic field

: 16% f.s. at 3 V

(typical value for measurement in AC 500 mA range)

Accessories

: 9170 TEST LEAD 2 sets, 9195 ENCLOSURE

PROBE 1, 9399 CARRYING CASE 1, Alligator

clips 3 (2 red, 1 black), AC power cord 2 (for

main unit, for power line of sample equipment),

Spare fuse 2 (for main unit power supply 250V

T0.1AL, for measurement operation 250V

T32mAL)

Dimensions

: Approx. 320W × 110H × 263D mm

Mass

: Approx. 4.0kg

## 3156 LEAK CURRENT HiTESTER

### ● Options

9637 RS-232C CABLE (9-pin to 9-pin., crossing cable, 1.8m)

9638 RS-232C CABLE (9-pin to 25-pin., crossing cable, 1.8m)

9151-02 GP-IB CABLE (2 m)

9151-04 GP-IB CABLE (4 m)

9442 PRINTER

9443-01 AC ADAPTER (for printer, for use in Japan)

9443-02 AC ADAPTER (for printer, for use in EU)

9443-03 AC ADAPTER (for printer, for use in U.S.)

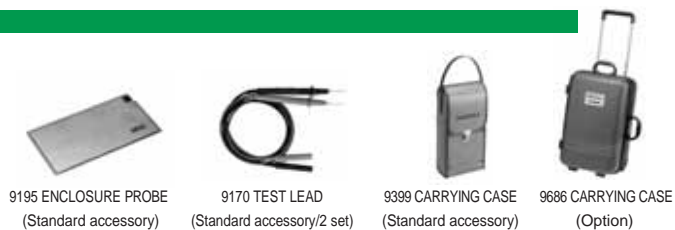

9444 CONNECTION CABLE (for printer)

1196 RECORDING PAPER (for printer)

9686 CARRYING CASE (with casters)

9267 SAFETY TEST DATA MEASUREMENT SOFTWARE

# HIOKI

HIOKI E. E. CORPORATION

HEAD OFFICE :

81 Koizumi, Ueda, Nagano, 386-1192, Japan  
TEL +81-268-28-0562 / FAX +81-268-28-0568  
E-mail: os-com@hioki.co.jp

HIOKI USA CORPORATION :

6 Corporate Drive, Cranbury, NJ 08512 USA  
TEL +1-609-409-9109 / FAX +1-609-409-9108  
E-mail: hioki@hiokiusa.com

Shanghai Representative Office :

1704 Shanghai Times Square Office  
93 Huaihai Zhong Road  
Shanghai, 200021, P.R.China  
TEL +86-21-6391-0090, 0092  
FAX +86-21-6391-0360  
E-mail: hioki-sh@81890.net

DISTRIBUTED BY