



LC7233N-8818

Single-Chip PLL and Controller with LCD Driver

Preliminary

Overview

The LC7233N-8818 is a single-chip electronic tuning microcontroller that supports control of an electronic tone/volume control IC (the LC7538JMD) and handles detachable front panel products based on the LC75853E/W keyed LCD driver. It is designed for automotive use and incorporates a PLL-based receiver that can receive all major worldwide radio transmissions.

Features

- Supports detachable front panel products. System chips: LC7233N, LC75853E/W and LC7538JMD
- Supports anti-theft LED flashing and reminder to remove panel alarm functions.
- Supports control of an electronic tone/volume control IC (the LC7538JMD). Functions: bass, treble, balance, fader
- Muting function (with key, out and electronic tone controls)
- Supports two color illumination control (dual systems).
- Reduced LCD display output pin count achieved by operating at 1/3 duty and 1/3 bias drive using the LC75853E/W.
- Up to 36 stations can be stored in preset memory: 6 stations for each band (FM1, FM2, FM3, VF, MW (MW1) and LW (MW2)). Previous station function also supported.
- Auto preset memory function
- Radio monitor output: operates during tape FF/REW.
- CD function (with key, in, and out)
- Tape function (Flashing direction display supported when FF and REW signal inputs are provided.)
- Rich selection of double function keys for use with tape players
- Tape character display
- Supports use of electronic power switch.
- Twenty diode matrix settings
- Supports radio reception throughout the world.
- Supports AM stereo reception in the USA and Japan.

Package Dimensions

unit: mm

3159-QFP64E

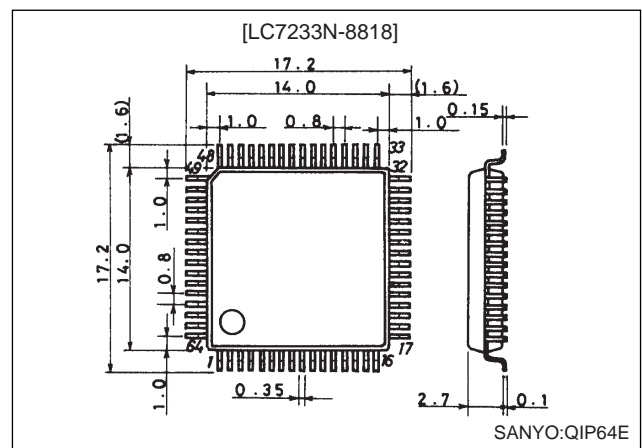

Contents

1. Pin Assignment	2
2. Electrical Characteristics	3
3. Radio Reception Frequencies	5
4. Key Matrix (LC75853E/W), Diode Matrix (DIMRX)	6
5. Pin Functions	7
6. Diode Matrix (DIMRX) Select	9
7. LCD Display Pattern (1/3 duty, 1/3 bias)	11
8. Display Examples	13
9. Key Functions	15
10. Power Connection	26
11. State Transition Diagram	26
12. Timing	28
13. Initial States	34
14. Tracking Point Frequency	34

LC7233N-8818

Pin Assignment

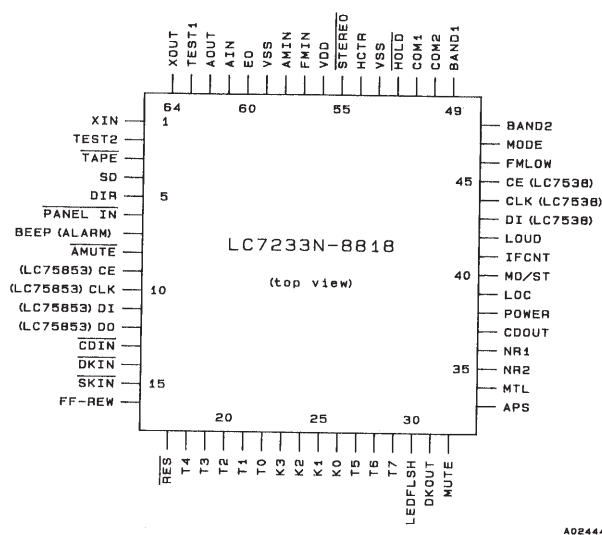

A02444

Specifications

Absolute Maximum Ratings at $T_a = 25^\circ\text{C}$, $V_{SS} = 0\text{ V}$

Parameter	Symbol	Conditions	Ratings	Unit
Maximum supply voltage	$V_{DD\text{ max}}$		-0.3 to +6.5	V
Input voltage	V_{IN1}	HOLD, STEREO, TAPE, SD, DIR, PANEL IN	-0.3 to +13	V
	V_{IN2}	Inputs other than V_{IN1}	-0.3 to $V_{DD} + 0.3$	V
Output voltage	V_{OUT1}	BEEP, AMUTE, AOUT	-0.3 to +15	V
	V_{OUT2}	Output other than V_{OUT1}	-0.3 to $V_{DD} + 0.3$	V
Output current	I_{OUT1}	BEEP, AMUTE	0 to 5	mA
	I_{OUT2}	CE, CLK, DI, DO (LC75853E/W), CDIN, DKIN, SKIN, FF-REW	0 to 3	mA
	I_{OUT3}	T0, T1, T2, T3, T4, RES	0 to 1	mA
	I_{OUT4}	AOUT	0 to 2	mA
Allowable power dissipation	$P_{d\text{ max}}$	$T_a = -40$ to $+85^\circ\text{C}$	400	mW
Operating temperature	T_{opr}		-40 to +85	$^\circ\text{C}$
Storage temperature	T_{stg}		-45 to +125	$^\circ\text{C}$

Allowable Operating Ranges at Ta = -40 to +85°C, V_{DD} = 3.5 to 5.5 V

Parameter	Symbol	Conditions	Ratings			Unit
			min	typ	max	
Supply voltage	V _{DD1}	CPU and PLL operation	4.5		5.5	V
	V _{DD2}	CPU operation	3.5		5.5	V
	V _{DD3}	Memory retained	1.3		5.5	V
Input high level voltage	V _{IH1}	$\overline{\text{TAPÉ}}$, SD, DIR, PANEL IN	0.7 V _{DD}		8.0	V
	V _{IH2}	HOLD	0.8 V _{DD}		8.0	V
	V _{IH3}	STEREO	2.5		8.0	V
	V _{IH4}	K0, K1, K2, K3	0.6 V _{DD}		V _{DD}	V
	V _{IH5}	DO (LC75853E/W), $\overline{\text{CDIN}}$, $\overline{\text{DKIN}}$, $\overline{\text{SKIN}}$, FF-REW	0.7 V _{DD}		V _{DD}	V
Input low level voltage	V _{IL1}	$\overline{\text{TAPÉ}}$, SD, DIR, PANEL IN	0		0.3 V _{DD}	V
	V _{IL2}	HOLD	0		0.4 V _{DD}	V
	V _{IL3}	STEREO	0		1.3	V
	V _{IL4}	K0, K1, K2, K3	0		0.2 V _{DD}	V
	V _{IL5}	DO (LC75853E/W), $\overline{\text{CDIN}}$, $\overline{\text{DKIN}}$, $\overline{\text{SKIN}}$, FF-REW	0		0.3 V _{DD}	V
Input frequency	F _{IN1}	XIN	4.0	4.5	5.0	MHz
	F _{IN2}	FMIN:V _{IN2} , V _{DD1}	10		130	MHz
	F _{IN3}	AMIN (LW, MW):V _{IN3} , V _{DD1}	0.5		10	MHz
	F _{IN4}	HCTR:V _{IN4} , V _{DD1}	0.4		12	MHz
Input amplitude	V _{IN1}	XIN	0.50		1.5	Vrms
	V _{IN2}	FMIN	0.10		1.5	Vrms
	V _{IN3}	AMIN	0.10		1.5	Vrms
	V _{IN4}	HCTR	0.10		1.5	Vrms

Electrical Characteristics for the Allowable Operating Ranges

Parameter	Symbol	Conditions	Ratings			Unit
			min	typ	max	
Power down detection voltage	V _{DET}		2.7	3.0	3.3	V
Input high level current	I _{IH1}	HOLD, $\overline{\text{TAPÉ}}$, SD, DIR, PANEL IN, STEREO: V _I = 5.5 V			3.0	μA
	I _{IH2}	XIN: V _I = V _{DD} = 5.0 V	2.0	5.0	15	μA
	I _{IH3}	FMIN, AMIN, HCTR: V _I = V _{DD} = 5.0 V	4.0	10	30	μA
	I _{IH4}	K0, K1, K2, K3: V _I = V _{DD} = 5.0 V		50		μA
	I _{IH5}	$\overline{\text{CDIN}}$, $\overline{\text{DKIN}}$, $\overline{\text{SKIN}}$, FF-REW, DO (LC75853E/W): V _I = V _{DD} = 5.0 V			3.0	μA
	I _{IH6}	AIN: V _I = V _{DD}		0.01	10	nA
Input low level current	I _{IL1}	HOLD, $\overline{\text{TAPÉ}}$, SD, DIR, PANEL IN: V _I = V _{SS}			3.0	μA
	I _{IL2}	XIN: V _I = V _{SS}	2.0	5.0	15	μA
	I _{IL3}	FMIN, AMIN, HCTR: V _I = V _{SS}	4.0	10	30	μA
	I _{IL4}	$\overline{\text{CDIN}}$, $\overline{\text{DKIN}}$, $\overline{\text{SKIN}}$, FF-REW, DO (LC75853E/W): V _I = V _{SS}			30	μA
	I _{IL5}	AIN: V _I = V _{SS}		0.01	10	nA
Input floating voltage	V _{IF}	K0, K1, K2, K3			0.05 V _{DD}	V
Pull-down resistance	R _{PD}	K0, K1, K2, K3: V _{DD} = 5 V	75	100	200	kΩ
Output off leakage current	I _{OFFH1}	EO: V _O = V _{DD}		0.01	10	nA
	I _{OFFH2}	T0, T1, T2, T3, T4, RES, $\overline{\text{CDIN}}$, $\overline{\text{DKIN}}$, $\overline{\text{SKIN}}$, FF-REW, DO (LC75853E/W): V _O = V _{DD}			3.0	μA
	I _{OFFH3}	BEEP, $\overline{\text{AMUTE}}$: V _O = 13 V			5.0	μA
	I _{OFFL1}	EO: V _O = V _{SS}		0.01	10	nA
	I _{OFFL2}	T0, T1, T2, T3, T4, RES, $\overline{\text{CDIN}}$, $\overline{\text{DKIN}}$, $\overline{\text{SKIN}}$, FF-REW, DO (LC75853E/W): V _O = V _{SS}			3.0	μA

Continued on next page.

LC7233N-8818

Continued from preceding page.

Parameter	Symbol	Conditions	Ratings			Unit
			min	typ	max	
Output high level voltage	V _{OH1}	T0, T1, T2, T3, T4, $\overline{\text{RES}}$: I _O = -1 mA	V _{DD} - 2.0	V _{DD} - 1.0	V _{DD} - 0.5	V
	V _{OH2}	CE, CLK, DI (LC75853E/W): I _O = -1 mA	V _{DD} - 1.0			V
	V _{OH3}	EO: I _O = 500 μA	V _{DD} - 1.0			V
	V _{OH4}	XOUT: I _O = 200 μA	V _{DD} - 1.0			V
	V _{OH5}	BAND1, BAND2, MODE, FMLOW, CE, CLK, DI (LC7538JMD), LOUD, IFCNT, MO/ST, LOC, POWER, CDOUT, NR1, NR2, MTL, APS, MUTE, DKOUT, LEDFLSH, T5, T6, T7: I _O = -0.1 mA	V _{DD} - 1.0			V
	V _{OH6}	COM1, COM2: I _O = 25 μA	V _{DD} - 0.75	V _{DD} - 0.5	V _{DD} - 0.3	V
Output low level voltage	V _{OL1}	T0, T1, T2, T3, T4, $\overline{\text{RES}}$: I _O = 50 μA	0.5	1.0	2.0	V
	V _{OL2}	CE, CLK, DI (LC75853E/W): I _O = 1 mA			1.0	V
	V _{OL3}	EO: I _O = 500 μA			1.0	V
	V _{OL4}	XOUT: I _O = 200 μA			1.0	V
	V _{OL5}	BAND1, BAND2, MODE, FMLOW, CE, CLK, DI (LC7538JMD), LOUD, IFCNT, MO/ST, LOC, POWER, CDOUT, NR1, NR2, MTL, APS, MUTE, DKOUT, LEDFLSH, T5, T6, T7: I _O = 0.1 mA			1.0	V
	V _{OL6}	AOUT: I _O = 0.5 mA, AIN = 1.3 V			0.5	V
	V _{OL7}	COM1, COM2: I _O = 25 μA	0.3	0.5	0.75	V
	V _{OL8}	BEEP, $\overline{\text{AMUTE}}$: I _O = 5 mA	0.75 (150 Ω)		2.0 (400 Ω)	V
Output intermediate level voltage	V _M	COM1, COM2: V _{DD} = 5 V, I _O = 20 μA	2.0	2.5	3.0	V
Supply current	I _{DD1}	V _{DD1} : F _{IN2} = 130 MHz		15	20	mA
	I _{DD2}	V _{DD2} : (Hold mode: see Figure 1.)		1.5		mA
	I _{DD3}	V _{DD} = 5.5 V, oscillator stopped, Ta = 25°C (Backup mode: see Figure 2.)			5	μA
	I _{DD4}	V _{DD} = 2.5 V, oscillator stopped, Ta = 25°C (Backup mode: see Figure 2.)			1	μA

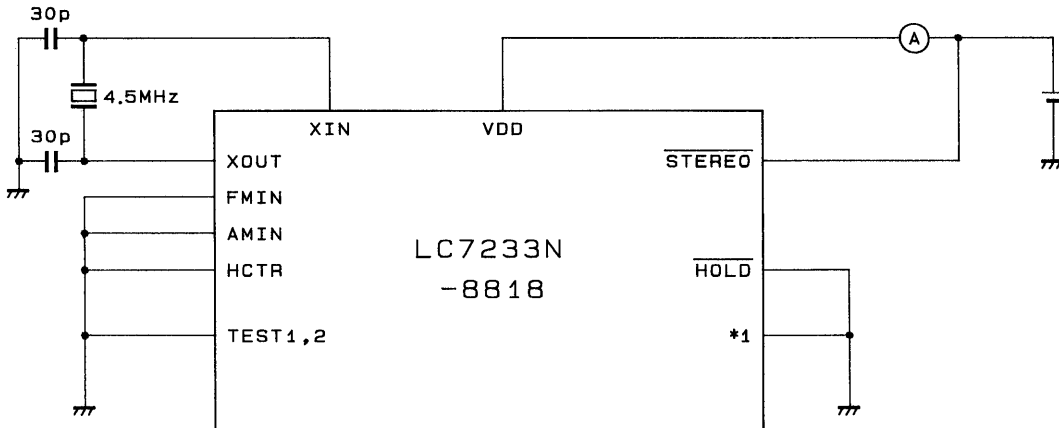

A02445

Unit (capacitance: F)

Note: * K0, K1, K2, K3, $\overline{\text{TAPÉ}}$, SD, DIR, $\overline{\text{PANEL IN}}$, DO (LC75853E/W)
All ports other than those specified above are left open.

Figure 1 I_{DD2} in Hold Mode

LC7233N-8818

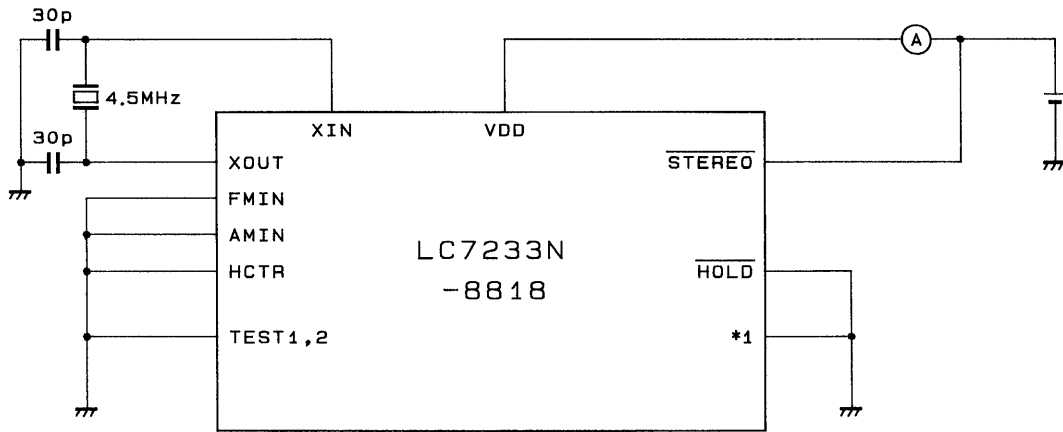

A02445

Note: All ports other than those specified above are left open.

Unit (capacitance: F)

Figure 2 I_{DD3} and I_{DD4} in Backup Mode

Radio Reception Frequencies

Area	Band	Frequency range (FM, SW: MHz AM: kHz)	Fref. (kHz)	Step (kHz)	IF FM (MHz) AM (kHz)	IF count tolerance (kHz)	Diode matrix (1: On 0: Off)					
							B2	B1	B0	LW2	LW1	SHIFT
U.S.A	FM a	87.5 — 107.9	25	200	10.7	±10						
	MW a	530 — 1720	10	10	450	±3	0	0	0	0	0	0
	FM b	87.5 — 108.0	25	100	10.7	±10						
	MW a	530 — 1720	10	10	450	±3	0	0	0	1	0	0
Southeast Asia	FM c	87.5 — 108.0	25	50	10.7	±10						
	MW h	531 — 1629	9	9	450	±3	0	0	0	1	1	1
Europe	FM c	87.5 — 108.0	25	50	10.7	±10						
		MW c	531 — 1620	9	9	450/459	±3	0	1	0		
	LW a	153 — 279	1	1 (9)	10.7	±0.6						
		450/459	±0.6				0	1				
	FM d	87.5 — 108.0	12.5	25	10.7	±10						
		MW c	531 — 1620	9	9	450/459	±3	1	0	0		
	LW a	153 — 279	1	1 (9)	10.7	±0.6						
		450/459	±0.6							0	1	
FM c	87.5 — 108.0	25	50	10.7	±10							
	MW c	531 — 1620	9	9	450/459	±3	0	1	0			0/1
LW b	146 — 290	1	1 (9)	10.7	±0.6							
	450/459	±0.6							1	0		
FM d	87.5 — 108.0	12.5	25	10.7	±10							
	MW c	531 — 1620	9	9	450/459	±3	1	0	0			0/1
LW b	146 — 290	1	1 (9)	10.7	±0.6							
	450/459	±0.6							1	0		
Japan	FM e	76.0 — 90.0	25	100	-10.7	±10						
	MW e	522 — 1629	9	9	450	±3	1	0	1	0	0	0
Saudi Arabia	FM b	87.5 — 108.0	25	100	10.7	±10						
	MW f	531 — 1602	9	9	450	±3	1	0	1	0	0	1
South Africa	FM f	87.5 — 108.0	25	100	-10.7	±10						
	MW g	531 — 1602	9	9	450	±3	1	0	1	0	1	0
East Europe	FM g	65.0 — 74.0	5	30	10.7	±10						
		87.5 — 108.0	25	50	10.7	±10	1	0	1	1	0	0
	MW c	531 — 1620	9	9	450	±3						

Note: 1. In Europe, the diode matrix SHIFT setting is used for IF selection.

2. The step size "(9)" refers to the step size in auto-tuning mode when IF counting is not performed.

Key Matrix (LC75853E/W)

IN OUT	KI1	KI2	KI3	KI4	KI5
KS1	M1 MTL	M2 DNR	M3 APS	M4	M5
KS2	M6	LOUD/RMON	MO/ST	UP/T-UP	DOWN/T-DOWN
KS3	BAND/ILL1	POWER	V-SEL	V-UP	V-DOWN
KS4	PS/AMEM	VF	SCAN UP	SEEK UP	SEEK DOWN
KS5	LOC	DISPLAY	CD	MUTE	

Diode Matrix (DIMRX)

	K0	K1	K2	K3
T0	B0 ▲	B1 ▲	B2 ▲	IFSHIFT ▲
T1	FMB0 ▲	FMB1 ▲	LW1 ▲	LW2 ▲
T2	IF COUNT0 ▲	IF COUNT1 ▲	COLON ▲	CLOCK ▲
T3	DOUBLE FUNCTION 0 ▲	DOUBLE FUNCTION 1 ▲	DOUBLE FUNCTION 2 ▲	FM ONLY ▲
T4	FADER ▲	EVR ON/OFF ▲	VF AUTORETUNE ▲	POWER OFF CLOCK ON ▲
T5	NR C ▲	PRIORITY ▲	POWER SW ▲	VF SELECT ▲
T6	AUTO500 ▲	CD SELECT ▲	RMON FF/REW ▲	AM STEREO SEL ▲
T7	-20 dB ▲	ACC OFF ALARM SEL ▲	MW2 SEL ▲	LED FLASH SEL ▲



=

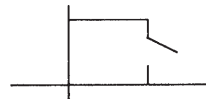

Momentary switch



=

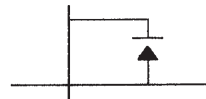

Diode matrix

LC7233N-8818

Pin Functions

Pin	Name	I/O	Allocation	Active	Function	Handling when unused
1	XIN	I	—	—	4.5 MHz crystal oscillator connection	—
2	TEST2	I	—	—	Ground connection	—
3	PG3	I	$\overline{\text{TAPÉ}}$	L	Tape input detection	Connect directly to V_{DD} .
4	PG2	I	SD	H	Signal that reports station reception during auto tuning	—
5	PG1	I	DIR	H/L	Tape direction display: The "▷" symbol is displayed on a high input, and the "◁" symbol on a low input.	Connect directly to V_{SS} or V_{DD} .
6	PG0	I	$\overline{\text{PANEL IN}}$	L	Detachable panel in/out detection: low indicates in, high indicates out. A 250 ms chatter rejection period is provided.	Connect directly to V_{SS} .
7	PH3	O	$\overline{\text{BEEP}}$ (ALARM)	L	Outputs a 50 ms 4.4 kHz pulse when a key is pressed. In VF mode, if the $\overline{\text{SKIN}}$ signal was high for 25 seconds (checked at approximately 25 ms intervals), this pin outputs an alarm signal and the LC7233N-8818 starts an auto up search for a low $\overline{\text{SKIN}}$ signal when a diode matrix VF SELECT setting of 0 is used. Since this pin uses an open drain output circuit, connect a pull-up resistor to this pin.	Open
8	PH2	O	$\overline{\text{AMUTE}}$	L	Audio mute out. When low, the LC7233N-8818 sends a "–79 dB" data message to the LC7538JMD. This pin is low when HOLD is low (clock enabled). Connect a pull-up resistor to this pin since it uses an open drain output.	Must be used.
9	PF3	O	CE	H	Connect to the LC75853E/W CE pin.	Must be used.
10	PF2	O	CL	H/L	Connect to the LC75853E/W CLOCK pin.	Must be used.
11	PF1	O	DI	H	Connect to the LC75853E/W DI pin.	Must be used.
12	PF0	I	DO	H	Connect to the LC75853E/W DO pin.	Must be used.
13	PE3	I	$\overline{\text{CDIN}}$	L	When this pin goes low, the LC7233N-8818 turns on the CD display, switches to CD mode, and sets the CDOUT pin high. If the CD key is pressed again in this state, the LC7233N-8818 turns off the CD display and sets CDOUT low. Similarly, if the CDIN pin goes low to high, the LC7233N-8818 turns off the CD display and sets CDOUT low. Note that the CD state cannot be switched with only the CD key if $\overline{\text{CDIN}}$ is high. The CD has the highest priority, with the total priority order being: CD > TAPE > RADIO.	Connect to V_{SS} .
14	PE2	I	$\overline{\text{DKIN}}$	L	In products for the European market, when the LC7233N-8818 is in VF mode and either tape or CD mode, the LC7233N-8818 will switch to radio mode allowing ARI broadcasts to be received if a low level is input to this pin (more precisely, if this signal is low three times in a row at 25 ms intervals). Also, after an SK SEEK, 250 ms after $\overline{\text{SKIN}}$ is determined to be low the LC7233N-8818 performs a DK determination.	Connect to V_{DD} .
15	PE1	I	$\overline{\text{SKIN}}$	L	If this signal goes low in FM mode with the diode matrix VF SELECT setting set to 1, the SK display is turned on. This does not depend on the on/off state of the $\overline{\text{VF}}$ key. When the $\overline{\text{VF}}$ key is pressed the LC7233N-8818 starts a search for a low $\overline{\text{SKIN}}$ signal. The LC7233N-8818 checks the signal about 375 to 500 ms after an SD is determined to exist, and if low, that channel is held. Thereafter, if a high level continues for 25 seconds (checked every 25 ms) the LC7233N-8818 starts an auto-retune operation. The LC7233N-8818 checks the $\overline{\text{SKIN}}$ signals in M1 to M6, skipping over channels with high $\overline{\text{SKIN}}$ signals and stopping at the first channel with a low $\overline{\text{SKIN}}$ signal.	Connect to V_{DD} .
16	PE0	I	FF-REW	H	If this pin goes high when the LC7233N-8818 is in tape mode, the LC7233N-8818 switches to radio monitor mode. Also at this time, the currently displayed scan display flashes at a 1 Hz rate. The LC7233N-8818 remains in tape mode while this pin is low.	Connect to V_{SS} .
17	PC1	O	$\overline{\text{RES}}$	L	Connected to the LC75853E/W RES pin	Open
18	PC0	O	T4	H	Diode scan out	Open
19	PB3	O	T3	H	Diode scan out	Open
20	PB2	O	T2	H	Diode scan out	Open
21	PB1	O	T1	H	Diode scan out	Open
22	PB0	O	T0	H	Diode scan out	Open
23	PA3	I	K3	H	Diode scan in	Open
24	PA2	I	K2	H	Diode scan in	Open
25	PA1	I	K1	H	Diode scan in	Open
26	PA0	I	K0	H	Diode scan in	Open

Continued on next page.

LC7233N-8818

Continued from preceding page.

Pin	Name	I/O	Allocation	Active	Function	Handling when unused																				
27	S23	O	T5	H	Diode scan out	Open																				
28	S22	O	T6	H	Diode scan out	Open																				
29	S21	O	T7	H	Diode scan out	Open																				
30	S20	O	LEDFLSH	H	Outputs a high level for 0.25 second and a low level for 0.75 second when PANEL IN goes high. However, the LC7233N-8818 only performs this operation when the diode matrix LED FLASH setting is 0.	Open																				
31	S19	O	DKOUT	H	Outputs a high level when DKIN goes low.	Open																				
32	S18	O	MUTE	H	Inverted by the mute key. When high, the volume level display flashes at a 1 Hz rate. Valid when HOLD is high and main power is on.	Open																				
33	S17	O	APS	H	In tape mode, outputs a high level when the APS display is lit, and a low level when that display is off. Valid when HOLD is high and main power is on.	Open																				
34	S16	O	MTL	H	In tape mode, outputs a high level when the MTL display is lit, and a low level when that display is off. Valid when HOLD is high and main power is on.	Open																				
35	S15	O	NR2	H	In tape mode when the diode matrix NR setting is 1 (i.e., when DNR-C is selected), outputs a high level when the DNR display and the C in the preset CH digit are lit, and a low level when that display is off. Valid when HOLD is high and main power is on.	Open																				
36	S14	O	NR1	H	In tape mode, outputs a high level when the DNR display and the B in the preset CH digit are lit, and a low level when that display is off. Valid when HOLD is high and main power is on.	Open																				
37	S13	O	CDOUT	H	CD source switch (See the CDIN pin description.)	Open																				
38	S12	O	POWER	H	Outputs a high level when the power is on (when the diode matrix POWER SW setting is 1 and the POWER key is on). Outputs low when power is off.	Open																				
39	S11	O	LOC	H	In radio mode when the LOC display is lit, outputs a high level only during seek or scan when a seek or scan is started. Outputs low when display is off. Valid when HOLD is high and main power is on.	Open																				
40	S10	O	MO/ST	H	In radio mode during FM reception (including VF and radio monitor), outputs a low level when the ST display is lit, and a high level when that display is off. However, note that this output is enabled for the US and Japanese MW band when the diode matrix AM ST SEL setting is 0. Outputs a low level in other modes, i.e., tape or CD mode, and when HOLD is low (clock enabled).	Open																				
41	S9	O	IFCNT	H	This signal switches the IF counter buffer on and off. Outputs a high level only when there is an SD during auto search, otherwise outputs a low level.	Open																				
42	S8	O	LOUD	H	Outputs a high level when the LOUD display is lit, and a low level when that display is off. Valid when HOLD is high and main power is on.	Open																				
43	S7	O	DI	H	Connected to the LC7538JMD DATA pin.	Open																				
44	S6	O	CL	H/L	Connected to the LC7538JMD CLOCK pin.	Open																				
45	S5	O	CE	H	Connected to the LC7538JMD CE pin.	Open																				
46	S4	O	FMLOW	H	Outputs a high level when the FM band is from 64.0 to 74.0 MHz, and a low level when the FM band is from 87.5 to 108.0 MHz.	Open																				
47	S3	O	MODE	H/L	Outputs a high level in radio mode, including when DK is on, and outputs a low level in tape and CD modes. Outputs a low level when HOLD is low and PANEL IN is high.	Open																				
48	S2	O	BAND2	H/L	<p>These signals change as shown in the table below when the band key is pressed.</p> <table border="1" style="width: 100%; border-collapse: collapse;"> <thead> <tr> <th>BAND</th> <th>BAND1</th> <th>BAND2</th> <th>Note</th> </tr> </thead> <tbody> <tr> <td>MW</td> <td>0</td> <td>0</td> <td>Including tape and CD modes</td> </tr> <tr> <td>LW</td> <td>0</td> <td>1</td> <td></td> </tr> <tr> <td>FM</td> <td>1</td> <td>0</td> <td></td> </tr> <tr> <td>VF</td> <td>1</td> <td>1</td> <td>Including times when DK is on</td> </tr> </tbody> </table> <p>Note: 0 = Low, 1 = High</p>	BAND	BAND1	BAND2	Note	MW	0	0	Including tape and CD modes	LW	0	1		FM	1	0		VF	1	1	Including times when DK is on	Must be used.
BAND	BAND1	BAND2	Note																							
MW	0	0	Including tape and CD modes																							
LW	0	1																								
FM	1	0																								
VF	1	1	Including times when DK is on																							
49	S1	O	BAND1	H/L																						
50	COM2	O	—	—	These pins are left open in normal operation.																					
51	COM1	O	—	—																						

Continued on next page.

LC7233N-8818

Continued from preceding page.

Pin	Name	I/O	Allocation	Active	Function	Handling when unused
52	$\overline{\text{HOLD}}$	I	$\overline{\text{HOLD}}$	L	Detects the external power switch on/off state. When HOLD goes from high to low: <ul style="list-style-type: none"> When the clock is enabled: The oscillator is not stopped and the clock continues to count. (Hold mode; $I_{DD} = 1.5 \text{ mA typ}$) When the clock is disabled (when the diode matrix LED FLASH setting is 1): The oscillator is stopped and the LC7233N-8818 enters low power mode. (Backup mode; $I_{DD} = 5 \mu\text{A max}$) 	Must be used.
53	ADI	I	V_{SS}	—	Connected to V_{SS} .	Connect directly to V_{SS} .
54	HCTR	I	HCTR	—	Inputs the FMIF and AMIF signals. Input an AC coupled signal of 100 mV rms or over. See the description of the diode matrix IFCOUNT0 and IFCOUNT1 settings. Tolerance: FM $\pm 10 \text{ kHz}$, MW $\pm 3 \text{ Hz}$, LW $\pm 0.6 \text{ kHz}$	Connect directly to V_{SS} .
55	$\overline{\text{SNS}}$	I	$\overline{\text{STEREO}}$	L	When HOLD is high, the <input type="checkbox"/> display is turned on 500 ms after a low level input in radio mode (FM or VF) only. Display starts 500 ms after $\overline{\text{HOLD}}$ goes from low to high. However, this function is also enabled in MW mode in products for the US and Japanese markets when the diode matrix AM ST SEL setting is 1.	Connect directly to V_{DD} .
56	V_{DD}	—	—	—	+5 V input	—
57	FMIN	I	—	—	FM local oscillator input Input an AC coupled signal of 100 mVrms or over.	Connect directly to V_{SS} .
58	AMIN	I	—	—	AM local oscillator input Input an AC coupled signal of 100 mVrms or over.	Connect directly to V_{SS} .
59	V_{SS}	—	—	—	Connected to ground.	—
60	EO	O	—	—	Phase comparator output: connected to the LPF input.	Must be used.
61	AIN	I	—	—	LPF amplifier input	Connect directly to V_{SS} .
62	AOUT	O	—	—	LPF amplifier output	Connect directly to V_{SS} .
63	TEST1	I	—	—	Connected to ground.	—
64	XOUT	O	—	—	4.5 MHz crystal oscillator connection	—

Diode Matrix (DIMRX) Select

0: without diode, 1: with diode

Diode matrix name	On/off	Function	
CLOCK	0	Clock function enabled. 12 Hr: USA, Japan, Saudi Arabia, South Africa, Southeast Asia 24 Hr: Europe, East Europe	
	1	Clock function disabled.	
CD SELECT	0	CD function disabled. $\overline{\text{CDIN}}$ disabled. The CDOUT pin outputs a low level. Connect $\overline{\text{CDIN}}$ to V_{DD} .	
	1	CD function enabled. When $\overline{\text{CDIN}}$ is low CDOUT will be high, and when $\overline{\text{CDIN}}$ is high CDOUT will be low. The CD key is also enabled. (See the item on the CDIN pin.)	
B0 B1 B2 IFSHIFT LW1 LW2	—	See the reception frequency table.	
FMB0 FMB1	FMB1	FMB0	Number of preset FM stations
	0	0	FM1, FM2, FM3 (18 stations)
	0	1	FM1, FM2 (12 stations)
	1	0	FM1 (6 stations)
	1	1	Illegal value
FM ONLY	0	The FM, MW, and LW bands are enabled.	
	1	Only the FM band is enabled. The band key is disabled. The number of FM bands depends on the diode matrix FMB0 and FMB1 settings.	

Continued on next page.

LC7233N-8818

Continued from preceding page.

0: without diode, 1: with diode

Diode matrix name	On/off	Function				
NR C	0	DNR C is disabled. The NR key switches noise reduction between off and NR B. DNR is displayed.				
	1	DNR C is enabled. The NR key switches noise reduction from off to NR B to NR C to off.				
		KEY on		Off	NR B	NR C
		Display (digit 1)		Off	 'DNR'	 'DNR'
Pin	NR1	L	H	L	L	
	NR2	L	L	L	H	
The mode is displayed in digit 5.						
POWER SW	0	The power is turned on and off using the HOLD pin. See section 9, "Power Connection Examples."				
	1	The power is turned on and off using the power key. See section 9, "Power Connection Examples."				
PRIORITY	0	Clock display takes priority.		When the clock function is enabled (the diode matrix CLOCK setting is 0).		
	1	Frequency, tape, or CD display takes priority.				
IFCOUNT0 IFCOUNT1	IFCOUNT1	IFCOUNT0	Enabled/disabled	HCTR pin	Note	
	0	0	Enabled	FMIF/AMIF	For use with FMIF/AMIF single pin tuner ICs.	
	0	1	Enabled	FMIF only		
	1	0	Enabled	AMIF only		
1	1	Disabled	Connected to GND.	LW seek is performed in 9 kHz steps.*		
COLON	0	The clock colon display is always lit.				
	1	The clock colon display flashes at 1 Hz.				
VF AUTORETUNE	0	In VF mode, the LC7233N-8818 retunes if SKIN is high continuously for 25 seconds. However, note that an alarm is output.				
	1	In VF mode, the LC7233N-8818 does not retune even if SKIN is high continuously for 25 seconds. Note that no alarm is output.				
VF SELECT	0	VF mode disabled.				
	1	VF mode enabled.				
POWER OFF CLOCK ON	0	The clock is not displayed when the main power is turned off.				
	1	The clock is always displayed when the main power is turned off.				
EVR ON/OFF	0	An electronic volume function is built in.				
	1	An electronic volume function is not built in. Nor is it displayed.				
FADER	0	A fader function is built in. The V-SEL key switches the fader as follows. 				
	1	No fader function is built in. 				
DOUBLE FUNCTION 0 FUNCTION 1 FUNCTION 2	M1, M2, and M3 can be independently selected with the radio mode and tape mode double function keys as shown in the table below. A "—" entry indicates that there is no double function.					
	FUNCTION2	FUNCTION1	FUNCTION0	M1	M2	M3
	0	0	0	—	—	—
	0	0	1	MTL	—	—
	0	1	0	NR	—	—
	0	1	1	MTL	NR	—
	1	0	0	APS	—	—
	1	0	1	MTL	APS	—
	1	1	0	NR	APS	—
1	1	1	MTL	NR	APS	
RMON FF/REW	0	The LC7233N-8818 switches to radio monitor mode regardless of the state of the radio monitor key when a high level is input to the FF-REW pin. The RMON display flashes at a 1 Hz rate.				
	1	The LC7233N-8818 switches to radio monitor mode when the RMON key is on, the RMON display is lit, and a high level is input to the FF-REW pin. The RMON display flashes at a 1 Hz rate. Invalid when the RMON display is off.				
AUTO500	0	The UP/DOWN keys perform manual up/down tuning operations.				
	1	The UP/DOWN keys function as T-UP/T-DOWN keys. If one of these keys is pressed for less than 500 ms, a manual tuning operation is performed, and if pressed for more than 500 ms, a seek tuning operation is performed.				

Note: * The seek for a manual up or down jumps in 9 kHz steps.

Continued on next page.

LC7233N-8818

Continued from preceding page.

0: without diode, 1: with diode

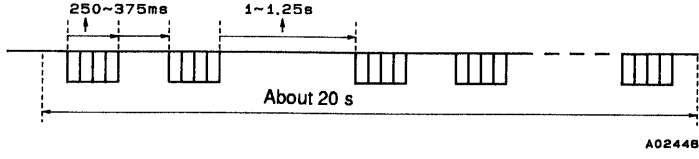

Diode matrix name	On/off	Function
AM ST SEL	0	The MO/ST key is disabled in the MW band when Japan or USA is selected.
	1	The MO/ST key is enabled in the MW band when Japan or USA is selected.
-20 dB	0	When the MUTE key is pressed and the MUTE output goes high, a -79 dB data item is sent to the electronic volume control IC.
	1	When the MUTE key is pressed and the MUTE output goes high, a data item for only -20 dB less than the current volume is sent to the electronic volume control IC.
ACC OFF ALARM SEL	0	When the LC7233N-8818 enters the ACC OFF state (when HOLD is low) a panel removal reminder alarm is not output from the ALARM pin.
	1	When the LC7233N-8818 enters the ACC OFF state (HOLD is low) a panel removal reminder alarm will be output from the ALARM pin. The alarm signal frequency is about 4.4 kHz, and lasts for about 20 seconds. 
MW2 SEL	0	There is no MW2 band, and only the MW band is displayed.
	1	When there is no LW band, the MW2 band is added, and these bands are referred to as MW1 and MW2. The display for MW1 is "MW I", and the display for MW2 is "MW II".
LED FLASH	0	A pulse (high for 250 ms, low for 750 ms) is output from the LEDFLSH pin in the ACC OFF state (HOLD is low) when PANEL IN is high.
	1	The LEDFLSH pin remains low when the LC7233N-8818 enters the ACC OFF state (when HOLD goes low) and PANEL IN is high. At this time the LC7233N-8818 enters backup mode if the clock function is disabled.

LCD Display Pattern (1/3 Duty, 1/3 Bias)

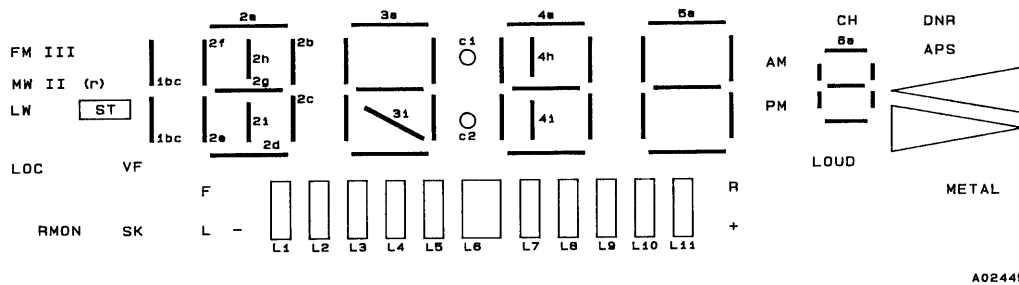
1. Digit Position



• LC75853 LCD pattern layout

	COM3	COM2	COM1
S14	I	II	FM
S15	I (l)* ¹	I (r)* ¹	MW* ²
S16		ST	LW
S17	RMON	VF	LOC
S18	1bc	F	SK
S19	2f	2e	2d
S20	2h	2g	2i
S21	2a	2b	2c
S22	3f	3e	3d
S23	c1	3g	3i
S24	3a	3b	3c
S25	4f	4e	4d
S26	4h	4g	4i
S27	4a	4b	4c
S28	5f	5e	5d
S29	c2* ³	5g	R* ⁴
S30	5a	5b	5c
S31	L		+ , -
S32	AM	PM	LOUD
S33	6f	6e	6d
S34	CH	6g	
S35	6a	6b	6c
S36	DNR	APS	
S37	L10	L11	METAL
S38	L7	L8	L9
S39	L4	L5	L6
S40	L1	L2	L3

- Note: 1. I(l) refers to the left side. I(r) refers to the right side.
 2. It is possible to display only the MW segment when only MW1 is enabled.
 3. c2 is shared between the clock colon and the frequency dp.
 4. R is shared between the Rear and Light displays.

2. Segment Pattern

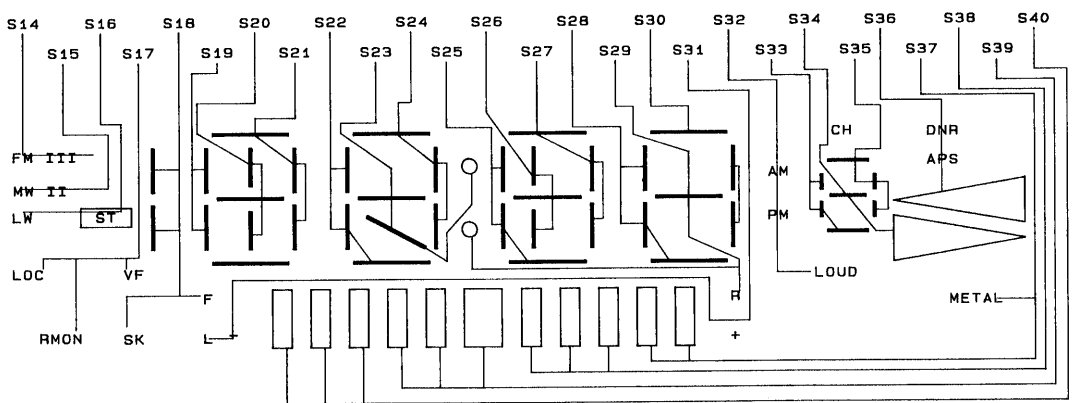

A02450

3. Common Pattern

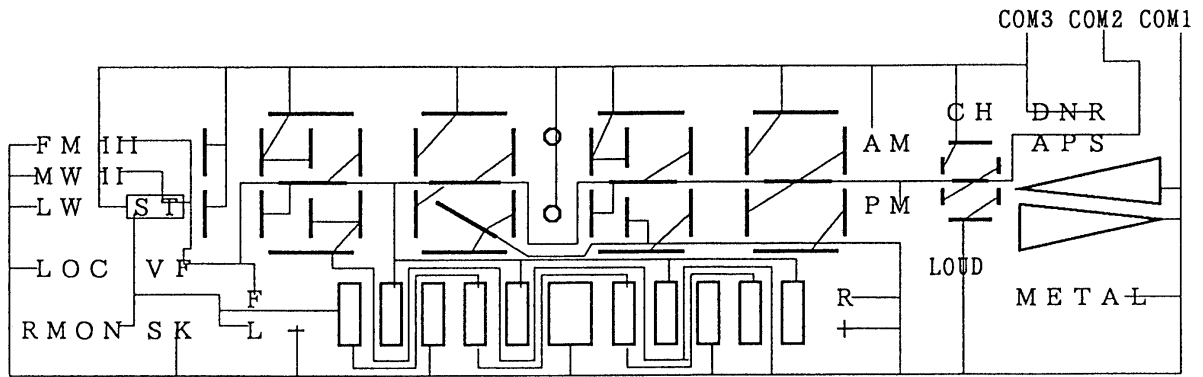

Display Examples

1. Tape

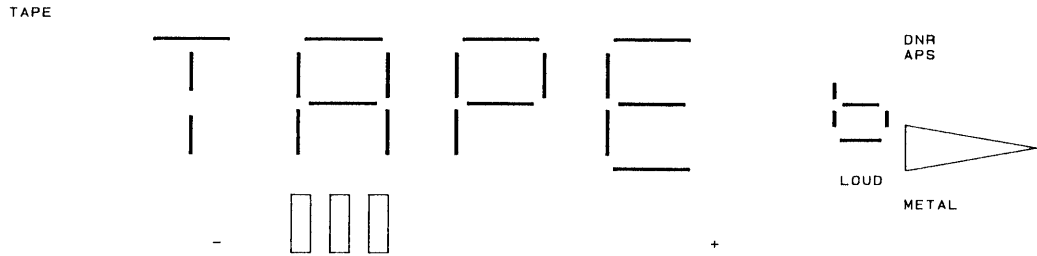

2. Volume

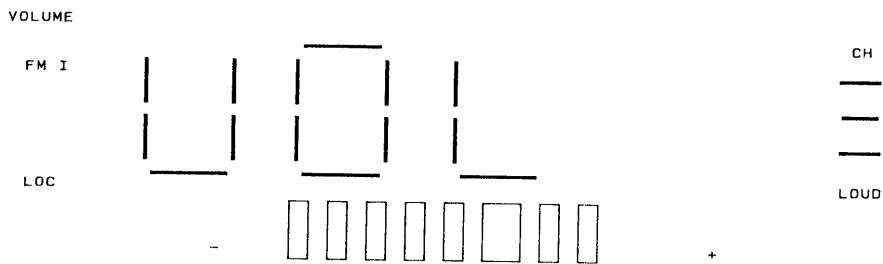

A02462

3. Balance

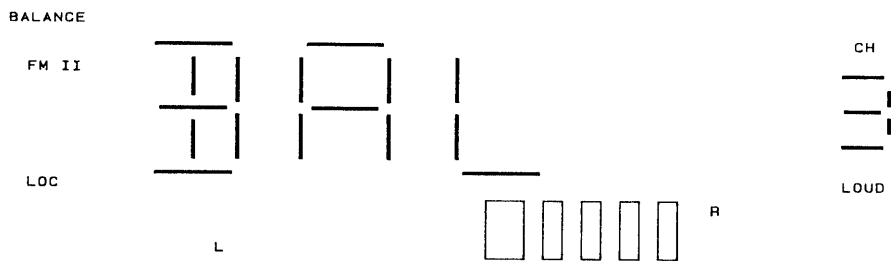

4. Bass

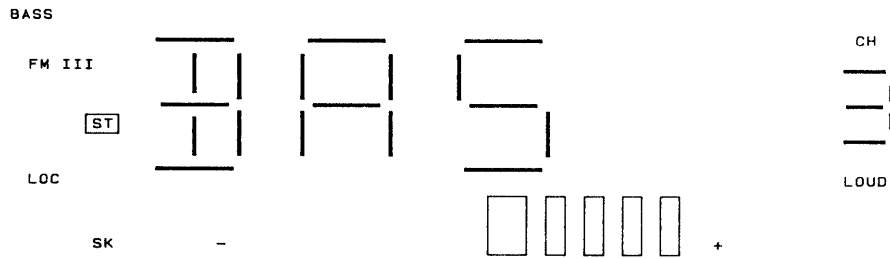

5. Treble

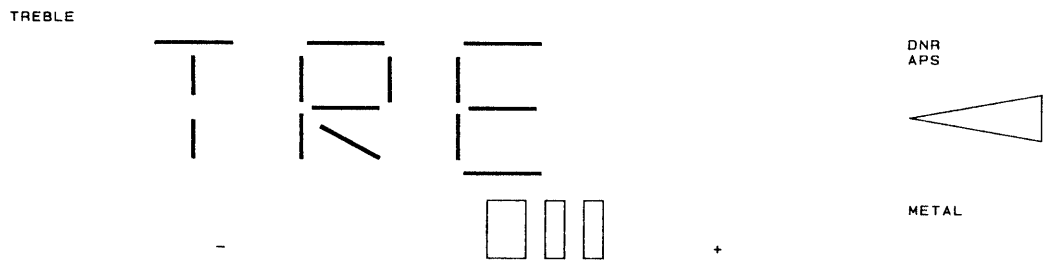

6. Fader

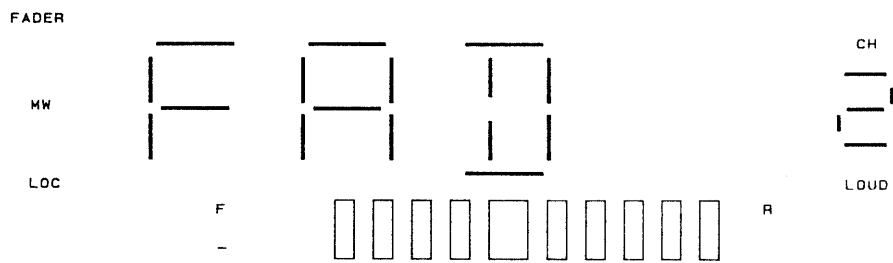

7. CD

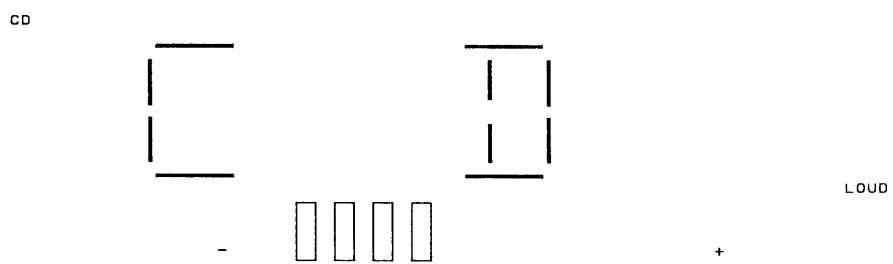

A02453

8. FM VF

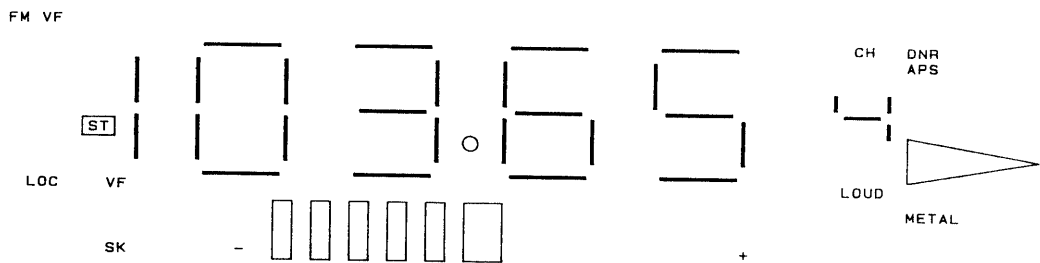

9. MW

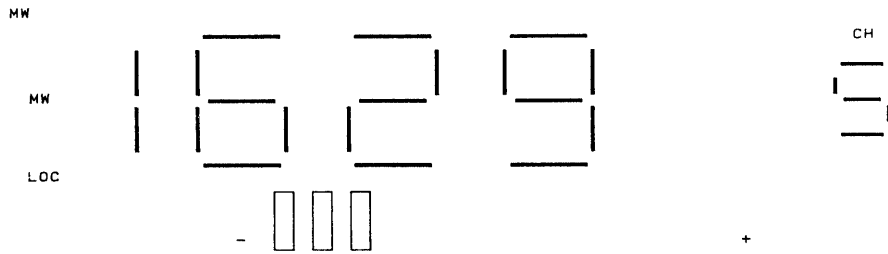

10. CLOCK (12 Hrs)

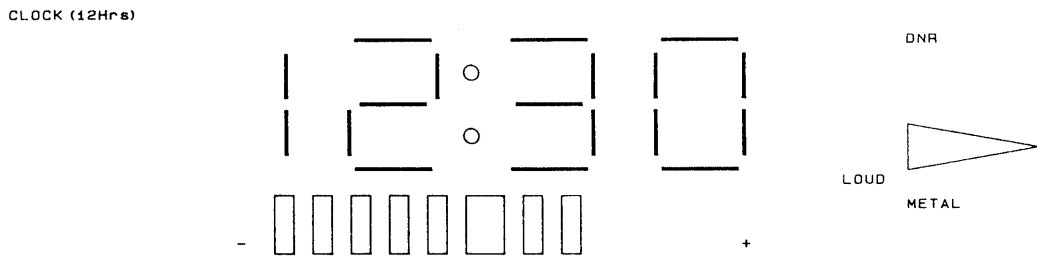

11. CLOCK (24 Hrs)

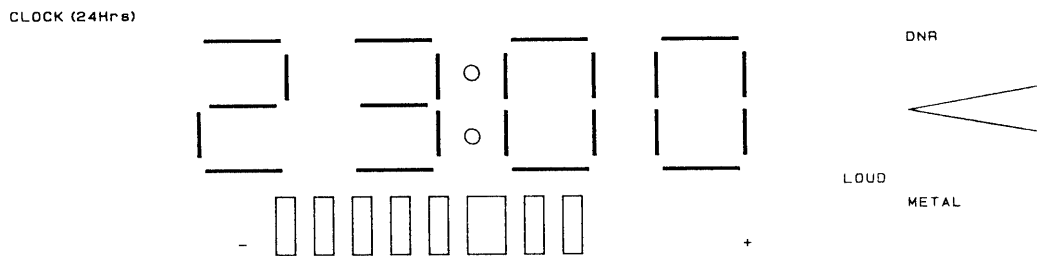

A02454

Key Functions

1. M1 to M6

- Radio mode

In radio mode, these keys are used for writing to and reading from preset memory. When one of the M1 to M6 keys is pressed, if it is released within 1.5 seconds, then the corresponding memory contents are recalled. If it is held down for over 1.5 seconds, then the currently displayed frequency is stored in the corresponding memory.

- Tape mode

In tape mode, the M1, M2, and M3 keys function as tape control keys. The function of these double function keys can be selected by changing diode matrix settings.

- VF mode

In VF mode, the M1 to M6 keys have tuning functions during tape and radio operation.

2. UP/T-UP, DOWN/T-DOWN

- When the diode matrix AUTO500 setting is 0.

Each time one of these tuning keys is pressed the frequency is increased or decreased by one step. If a tuning key is held down for over 500 ms, the frequency is advanced rapidly at about 70 ms per step. When the frequency changes from band edge to band edge, the LC7233N-8818 pauses for about 500 ms.

- When the diode matrix AUTO500 setting is 1.

When these keys are held down for less than 500 ms they function as manual tuning keys, and when held down for over 500 ms, the LC7233N-8818 enters seek mode.

Both of these functions are valid when $\overline{\text{HOLD}}$ is high, $\overline{\text{PANEL IN}}$ is low and main power is on.

In VF mode, these keys function as seek up and seek down keys.

3. DISPLAY + UP/T-UP

When the time is displayed, pressing these keys at the same time adjusts the minutes setting. Each time these keys are pressed and held down for less than 500 ms the time setting is advanced by one minute, and if they are held down for over 500 ms, the time setting is advanced at eight minutes per second. These operations reset the seconds setting to zero.

4. DISPLAY + DOWN/T-DOWN

When the time is displayed, pressing these keys at the same time adjust the hour setting. Each time these keys are pressed the time setting is advanced by one hour, and if they are held down for over 500 ms, the time setting is advanced at four hours per second. The minute and second settings do not change due to this operation.

5. SEEK UP, SEEK DOWN

These keys automatically search for a station broadcast and lock onto the received station. If the SCAN key is pressed during a seek, the LC7233N-8818 switches to scan mode. Therefore, if the SCAN UP key is pressed during a downward seek, an upwards scan is started. Also, during a seek up (down), if seek down (up) is pressed, a seek down (up) operation is started. The search mode is cleared by pressing the same key a second time. When the frequency changes from one band edge to another, the LC7233N-8818 pauses for 500 ms. The search speed is 50 ms/step for FM and 70 ms/step for AM.

These functions are valid when $\overline{\text{HOLD}}$ is high, $\overline{\text{PANEL IN}}$ is low and main power is on.

6. SCAN UP

The scan function automatically searches for the next station, and when a station is found holds that station for 5 seconds (with AMUTE at the high level) and flashes the channel display. Pressing this key once more during that interval causes the LC7233N-8818 to hold at that station. If no user action occurs during that 5 second interval, the search resumes.

Pressing the SEEK DOWN key during a scan starts a downward seek operation. Scan mode is cleared by pressing the SCAN UP key a second time. When the frequency changes from one band edge to another, the LC7233N-8818 pauses for 500 ms.

The search speed is 50 ms/step for FM and 70 ms/step for AM.

This function is valid when $\overline{\text{HOLD}}$ is high, $\overline{\text{PANEL IN}}$ is low and main power is on.

7. BAND/ILL1

- This key switches the band as shown below when released within 1.5 seconds.

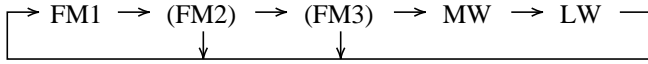

This function is valid when $\overline{\text{HOLD}}$ is high, $\overline{\text{PANEL IN}}$ is low and main power is on.

- Holding this key down for more than 1.5 seconds inverts the output of the LC75853E/W S1 pin from low to high or from high to low. Its initial state is the low level. This function is valid when $\overline{\text{HOLD}}$ is high, $\overline{\text{PANEL IN}}$ is low and main power is on.

8. VF

Pressing this key in radio mode switches the LC7233N-8818 to FM band radio mode regardless of which band was previously selected. The VF display is turned on and the BAND1 and BAND2 outputs go high. The SD pin is checked 375 ms later (500 ms later if the previous band was the AM band) and after another 375 to 500 ms the SKIN input is checked. If the input was low, the current frequency is held, and if high, an automatic SK station search is started. When the input goes low, that frequency is held. (See the state transition diagram on page 18.)

The SK display is lit if $\overline{\text{SKIN}}$ is low, the mode is FM, and the LC7233N-8818 is set for European reception.

Key	Display state		Output state	
			BAND1	BAND2
VF	VF	Lit	H	H
		Off	*	*

Note: * The state from the previous band.

Pressing the VF SEEK key causes the LC7233N-8818 to perform the operation shown in the table below based on the VF mode and the SKIN signal state.

VF (VF mode)	$\overline{\text{SKIN}}$	When the VF key is pressed	When the SEEK key is pressed	When, during a seek, the seek key for the same direction is pressed	When the VF key is pressed during a seek.
Off	H	VF mode is turned on and an SK station search is started.	A normal station search is started.	The LC7233N-8818 stops at the frequency where pressed.	VF mode is turned on and an SK station search is started.
Off	L	VF mode is turned on.	A normal station search is started.	The LC7233N-8818 stops at the frequency where pressed.	VF mode is turned on and an SK station search is started.
On	H/L	VF mode is turned off.	An SK station search is started.	The seek continues.	VF mode is turned off and the LC7233N-8818 returns to the state prior to entering VF mode.

- In tape or CD mode (when VF mode is off), the operation shown in the table below is performed based on the SKIN and DKIN signal states.

	$\overline{\text{SKIN}}$	$\overline{\text{DKIN}}$	Operation when VF mode is switched from off to on by pressing the VF key in tape or CD mode	Mode
①	H	H	The LC7233N-8818 displays the frequency and starts an SKIN signal seek up operation. The display reverts to tape or CD when a low level $\overline{\text{SKIN}}$ signal frequency is found. If $\overline{\text{DKIN}}$ is low, operation ③ below is performed.	TAPE mode CD mode
②	L	H	The display remains in tape or CD display mode. If $\overline{\text{DKIN}}$ is low, operation ③ below is performed. If the diode matrix VF AUTORETUNE setting is 0, a retune operation is performed if $\overline{\text{SKIN}}$ had been low for 25 seconds (checked every 25 ms). The frequencies in M1 to M6 are checked for a high SKIN signal, and if none is found, a seek up operation is performed.	TAPE mode CD mode
③	L	L	The frequency is displayed and an ARI broadcast is started.	VF mode

When the radio monitor function is on and VF mode is switched from off to on, the radio monitor function is cleared and operation ① or ② is performed.

- During power on ($\overline{\text{HOLD}}$ switching from low to high), $\overline{\text{SKIN}}$ is checked for 25 seconds, and a retune operation is started if it was high. The frequencies in M1 to M6 are checked for a high SKIN signal, and if none is found, a seek up operation is performed.
- This function is valid when $\overline{\text{HOLD}}$ is high, $\overline{\text{PANEL IN}}$ is low and main power is on.
- VF mode is cleared by pressing the VF or BAND keys. However, the BAND key will not work when the $\overline{\text{TAPE}}$ signal is low, CD mode is on, or the radio monitor function is on.

The figure below shows the state transition diagram for VF mode.

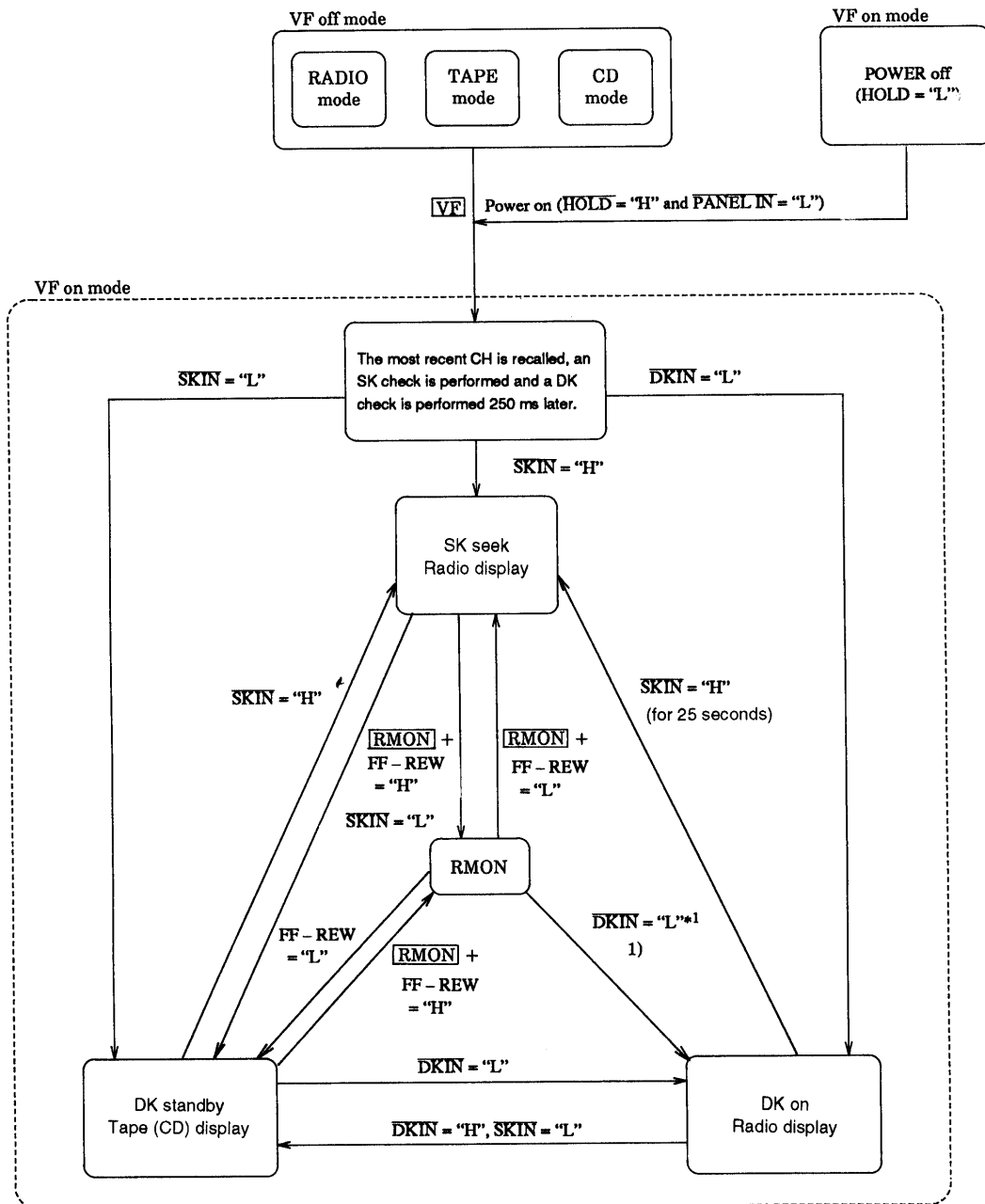

A02455

- Note: 1. The radio monitor function is cleared at this time.
 2. Keys are indicated in boxes.
 3. When VF mode is switched from on to off the radio monitor function is cleared if it was enabled.

9. PS/AMEM

Pressing this key for under 2 seconds invokes the preset scan function, and pressing it for over 2 seconds invokes the auto store memory operation.

This function is valid when $\overline{\text{HOLD}}$ is high and main power is on.

- PS operation

Pressing this key starts a preset channel search in increasing channel number order starting with the channel following the currently displayed channel number. When no channel number is being displayed, the search starts at channel number 1. If a station is being received, the AMUTE (which is high) is cleared for 5 seconds. The LOC/DX switch is set to DX regardless of its current setting state, and the channel number display flashes at a 1 Hz rate during the preset channel search.

This function is cleared by pressing the PS key a second time.

The keys listed below will also clear this functions.

PS/AMEM, SEEK UP, SEEK DOWN, SCAN, UP, DOWN, M1 to M6, POWER, BAND, VF

Furthermore, it is also cleared by the $\overline{\text{HOLD}}$ signal going from high to low, or by the LC7233N-8818 entering tape or CD mode.

The preset scan direction operates as shown below depending on the diode matrix FMB0, FMB1 and B0 to B2 settings.

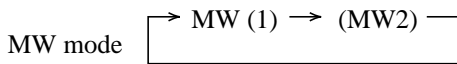
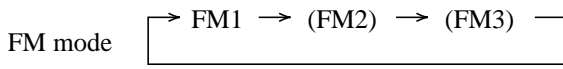

- Auto memory (AMEM) operation

When this key is held down for over 2 seconds, the LC7233N-8818 starts the auto memory operation. This operation is performed in two cycles, the first in local mode (with the LOC pin high) and the second in DX mode (with the loc pin low). The search starts from the low end of the band and stores the stations found in order from M1 to M6. If all memories were not filled in local mode, it proceeds to the second cycle.

— FM band

- [FM1, FM2 and FM3 selected] (diode matrix FMB0 and FMB1 set to 0 and 0)
 - : When started from the FM1 band stations are stored from FM1 M1 to FM1 M6Six stations
 - : When started from the FM2 band stations are stored from FM2 M1 to FM2 M6Six stations
 - : When started from the FM3 band stations are stored from FM3 M1 to FM3 M6Six stations
- [FM1 and FM2 selected] (diode matrix FMB0 and FMB1 set to 1 and 0)
 - : When started from the FM1 band stations are stored from FM1 M1 to FM1 M6Six stations
 - : When started from the FM2 band stations are stored from FM2 M1 to FM2 M6Six stations
- [Only FM1 selected] (diode matrix FMB0 and FMB1 set to 0 and 1)
 - : When started from the FM1 band stations are stored from FM1 M1 to FM1 M6Six stations
- [VF selected] (diode matrix VF SELECT set to 1)
 - : When started from the VF band stations are stored from VF M1 to VF M6Six stations

— MW and LW bands

Initially the LOC pin is set high, and stations are stored in local mode starting at M1. If stations were not stored through M6, the LOC pin is set to low, and storing continues in DX mode.

— When the LW band is not supported, i.e., the diode matrix MW2 SEL is set to 1 (bands MW1 and MW2 provided)

: When started from the MW1 band stations are stored from MW1 M1 to MW1 M6Six stations

: When started from the MW2 band stations are stored from MW2 M1 to MW2 M6Six stations

During the auto memory operation, whatever band is selected, the channel number  is displayed flashing at a 1 Hz rate. When the operation completes, the LC7233N-8818 executes a PS search operation if any stations were stored in memory. If no stations were found, the contents of memory channel M1 are recalled.

The following keys will cancel this operation.

PS/AMEM, POWER, BAND, VF, CD

Furthermore, this operation is also cleared by the $\overline{\text{HOLD}}$ signal going from high to low, or by the LC7233N-8818 entering tape or CD mode.

10. CD

When the $\overline{\text{CDIN}}$ signal is low, pressing this key switches the LC7233N-8818 to CD mode. The CD display is lit and the CDOUT signal is set high.

Key	Display state	Output state	
CD		Lit	H
		Off	L

If this key is pressed again CD mode is cleared, the CD display is turned off and CDOUT is set low.

When the $\overline{\text{HOLD}}$ input is high, this key switches the LC7233N-8818 to CD mode with the highest priority. CD mode is not cleared by switching the $\overline{\text{HOLD}}$ signal from high to low and back to high again. Nor is it cleared by switching the power from on to off and back on again.

This operation is valid when $\overline{\text{HOLD}}$ is high and system power is on.

11. DISPLAY

When the clock function is enabled, i.e, the diode matrix CLOCK setting is 0, this key is used to switch the display with that for the current mode, e.g. between clock and frequency display, clock and tape display, and clock and CD display. This operation is valid when $\overline{\text{HOLD}}$ is high and main power is on.

This operation is valid when $\overline{\text{HOLD}}$ is high and main power is on or off.

Mode	DIMRX "PRIORITY" = 0 (Clock display takes priority)	DIMRX "PRIORITY" = 1
RADIO mode	<p>* RADIO key</p> <p>PS/AMEM, SEEK UP, SEEK DOWN, SCAN, UP, DOWN M1-M6, POWER, BAND, VF, LOC</p>	<p>However, note that if a radio key is pressed during clock display, the LC7233N-8818 returns to frequency display even if the 5 seconds have not elapsed.</p>
TAPE mode	<p>• During tape input, tape display is performed for 5 seconds.</p>	
CD mode	<p>• During CD input, CD display is performed for 5 seconds.</p>	
VF mode	<p>During tape or CD input</p>	<p>SK search</p>

12. LOC

When this key is pressed in radio mode the LOC display is turned on. If the SEEK key or the SCAN key is pressed in this state, the LOC pin goes high and a local search is performed. When the seek or scan function is cleared the LOC pin goes low. (See section Timing-4.)

Key	Display state	Normal operation output state	Search operation output state
LOC	Lit	L	H
	Off	L	L

This operation is valid when $\overline{\text{HOLD}}$ is high and main power is on.

13. LOUD/RMON

- When pressed for less than 1.5 seconds:

Pressing this key turns on the LOUD display and sets the LOUD pin to the high level. Pressing the key again turns off the LOUD display and sets the LOUD pin to the low level. This operation also turns on and off the loudness function implemented in the LC7538JMD.

Key	Display state		Output state
LOUD	LOUD	Lit	H
		Off	L

This operation is valid when $\overline{\text{HOLD}}$ is high and main power is on.

- When pressed and held down for over 1.5 seconds:
 1. When the diode matrix RMON FF/REW setting is 0:

This key operation has no effect. When the FF-REW pin goes high, regardless of the state of this key, the LC7233N-8818 enters radio monitor mode temporarily. The RMON display flashes at a 1 Hz rate and radio reception becomes possible.

2. When the diode matrix RMON FF/REW setting is 1:

When this key is pressed the RMON display lights. When the FF-REW pin goes high in this state, the LC7233N-8818 enters radio monitor mode temporarily. The RMON display flashes at a 1 Hz rate and radio reception becomes possible. Pressing this key again clears radio monitor mode and returns the LC7233N-8818 to the previous mode.

Operations 1 and 2 are both possible in VF mode even in the DK wait (standby) state.

Key	Display State (setting state)		FF-REW	
			L	H
RMON	RMON	Lit (enabled)	Lit	Blinking at a 1 Hz rate
		Off (disabled)	Off	

This operation is valid when $\overline{\text{HOLD}}$ is high and main power is on.

14. POWER (when the diode matrix POWER SW setting is 1)

This key is used when the tact key in the key matrix controls the power. When this key is pressed the POWER pin goes high and furthermore, the LC7233N-8818 switches to tape mode if there is tape input or to CD mode if CD is on, i.e., if the $\overline{\text{CDIN}}$ pin is low.

15. MO/ST

When the LC7233N-8818 is in an FM radio mode (including VF mode), pressing this key turns on the ST display. Pressing this key again turns off the ST display.

Key	Display state		Output state
MO/ST	ST	Lit	L
		Off	H

However, note that this operation is valid for both the FM and MW bands in products for the US and Japanese markets when the diode matrix AM ST SEL setting is 1. This setting can be specified independently for the FM and MW bands (but not for each of the FM1, FM2, FM3, MW1 and MW2 bands).

16. V-SEL

When this key is pressed, a cyclic operation is started from the bass setting, which is the next item in the cycle. Five seconds after the key is released, the LC7233N-8818 automatically returns to the volume control position and the seven segment character display returns to frequency, tape, or CD display. However, if the V-UP or V-DOWN key is pressed within 5 seconds, then five seconds after that key is released, the LC7233N-8818 automatically returns to the volume control position and the seven segment character display returns to frequency, tape, or CD display.



Note: * When the diode matrix FADER setting is 1.

When this key is first pressed, the cycle always starts from the volume position.

17. V-UP and V-DOWN

These keys increase or decrease a level setting in 2 dB steps each time they are pressed. When DK is on, the volume can be increased up to -30 dB. When the volume is -30 dB or over, it remains at that level.

• Volume mode

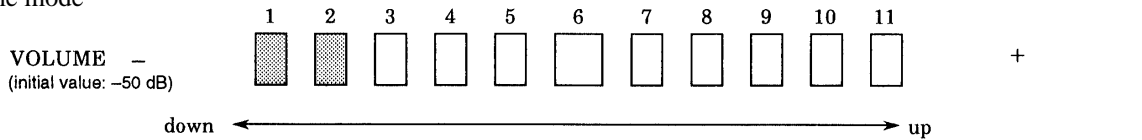

When the V-UP or the V-DOWN key is held down for over 500 ms, the level setting is increased or decreased at a 150 ms/dB rate.

Display point	1	2	3	4	5	6	7	8	9	10	11
Volume (dB)	∞	-50	-42	-34	-26	-18	-12	-8	-4	-2	0

When the value falls under the value listed in the table, the display shifts to the next point.

• Bass/Treble mode

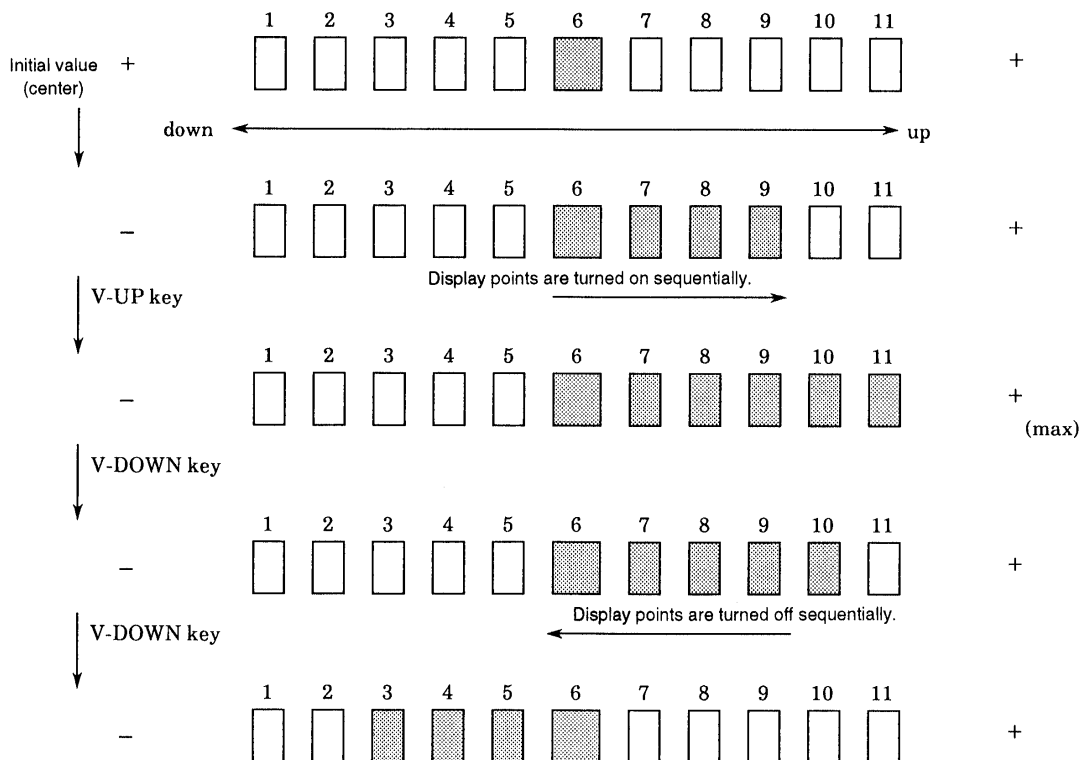

LC7233N-8818

The bass or treble is shifted at a 150 ms/step rate when the V-UP or V-DOWN key is held down for over 500 ms.

Display point	1	2	3	4	5	6	7	8	9	10	11
Step value	1	2	3	4	5	6	7	8	9	10	11

- Balance mode

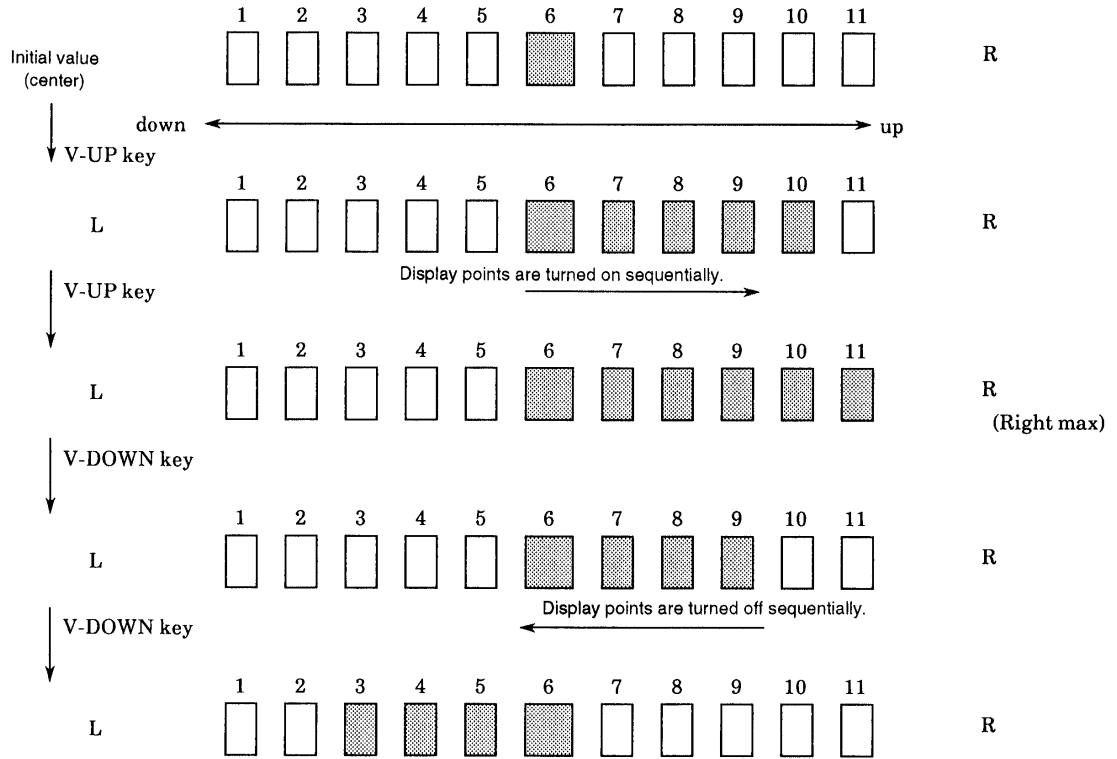

The balance is shifted at a 150 ms/dB rate when the V-UP or V-DOWN key is held down for over 500 ms.

Display point	1	2	3	4	5	6	7	8	9	10	11
Volume difference (dB)	$-\infty$	-20	-8	-4	-2	0	-2	-4	-8	-20	$-\infty$

• Fader mode

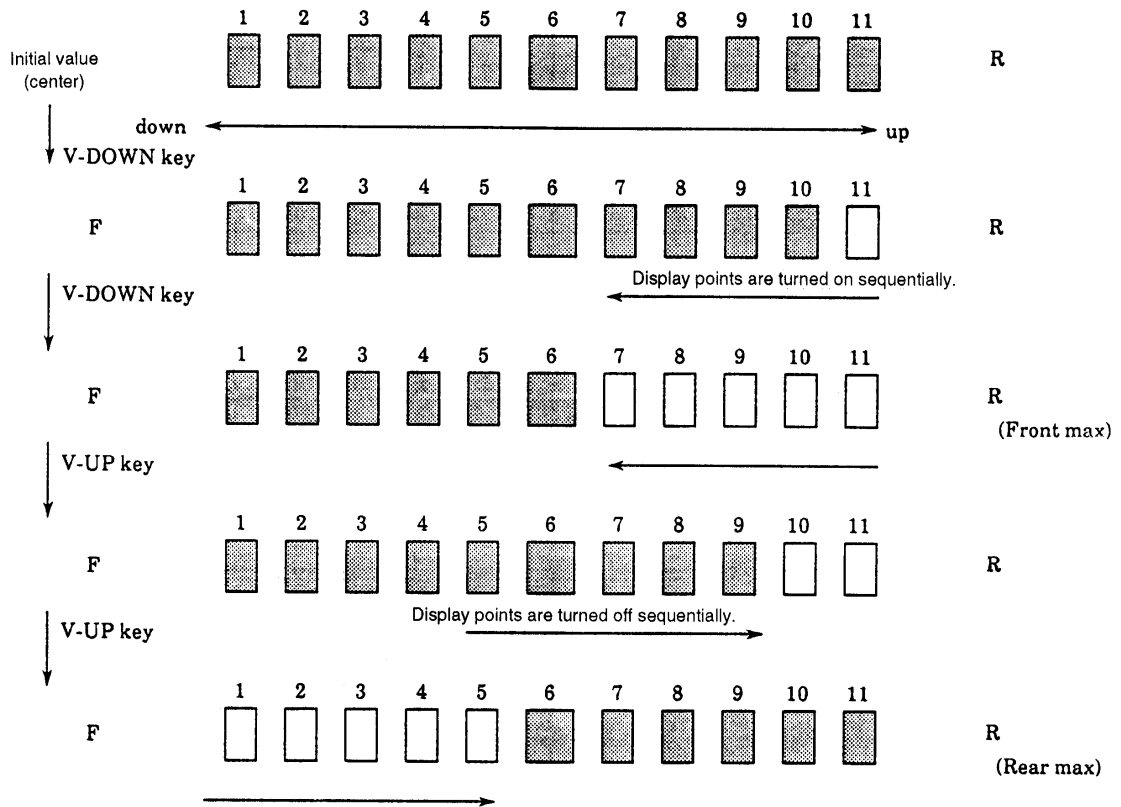

The fader is shifted at a 150 ms/dB rate when the V-UP or V-DOWN key is held down for over 500 ms.

Display point	1	2	3	4	5	6	7	8	9	10	11
Volume difference (dB)	-45	-20	-14	-8	-2	0	-2	-8	-14	-20	-45

18. Mute

When the diode matrix -20 dB setting is 0, pressing this key sets the MUTE pin high and the $\overline{\text{AMUTE}}$ pin low, and when the diode matrix -20 dB setting is 1, pressing this key sets the MUTE and $\overline{\text{AMUTE}}$ pins high. When the key is pressed again the changed pins are returned to their previous state. The LC75853E/W volume setting is set to -79 dB by this operation. Additionally, the volume level display (not including the + or - indicators) flashes at a 1 Hz rate. In the initial state the MUTE pin is low.

19. ILL2 Port (the LC75853E/W pin 2)

	RADIO	TAPE or CD	When HOLD is low, or in the initial state
S2 (2 pin)	H	L	L

The state of the LC75853 S2 changes depending on whether the LC7233N-8818 is in radio mode or tape mode.

Valid when $\overline{\text{PANEL IN}}$ is low.

This is optimal for two-color illumination control based on the mode when A_{CC} is on (i.e., main power is on).

Power Connection

1. POWER Key Systems (when the diode matrix POWER SW setting is 1)

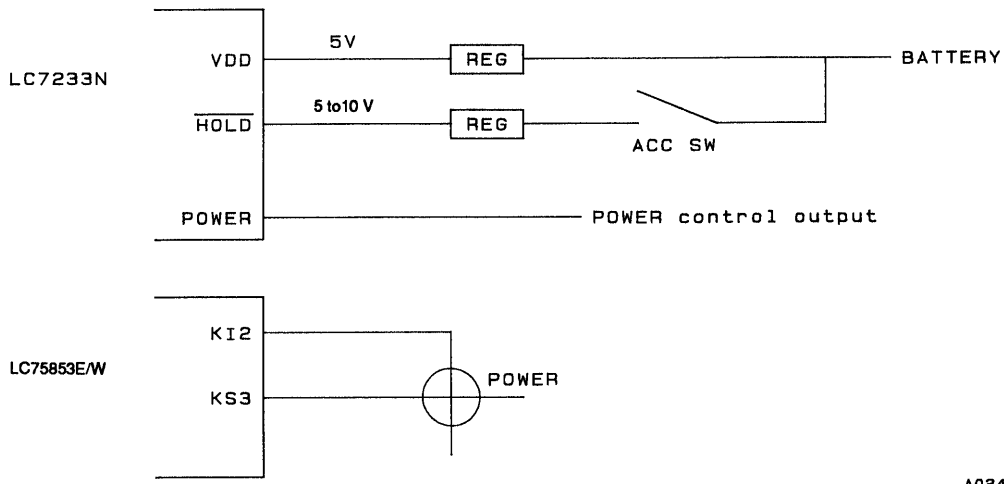

A02457

2. External Power Switch Systems (when the diode matrix POWER SW setting is 0)

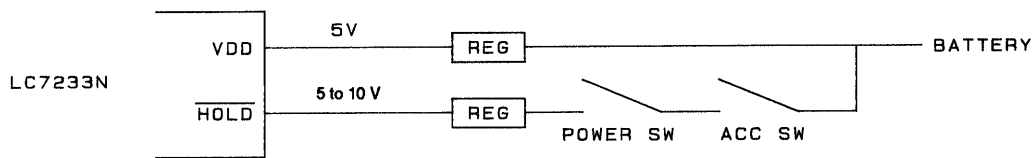

A02458

State Transition Diagram

1. Normal Mode, Clock Disabled

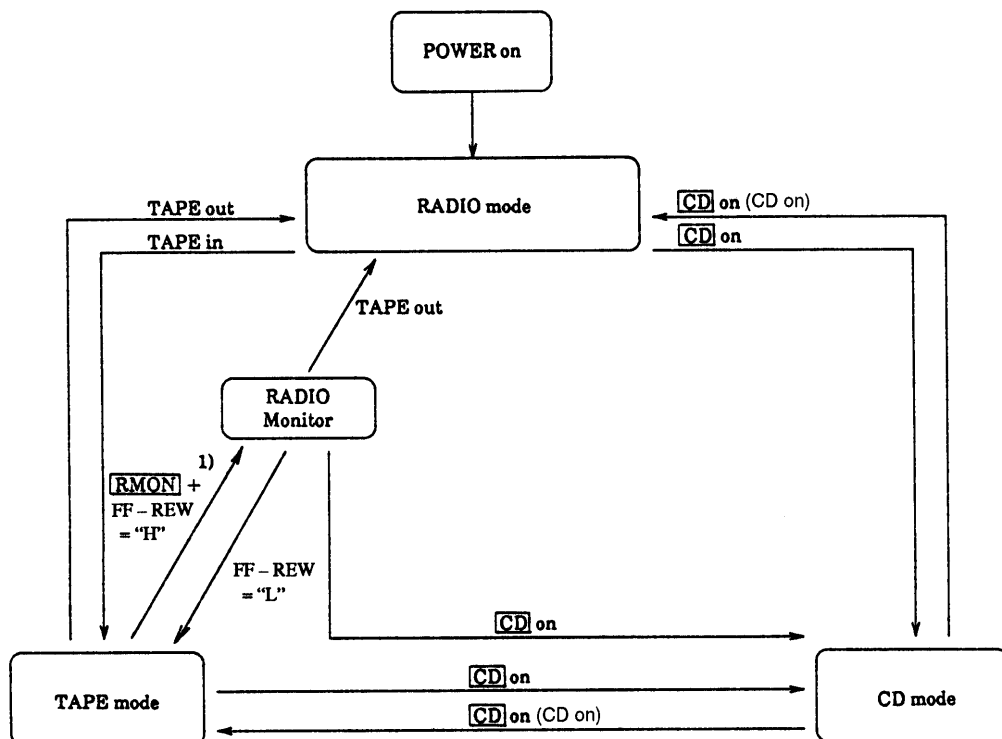

A02459

2. Normal Mode, Clock Enabled

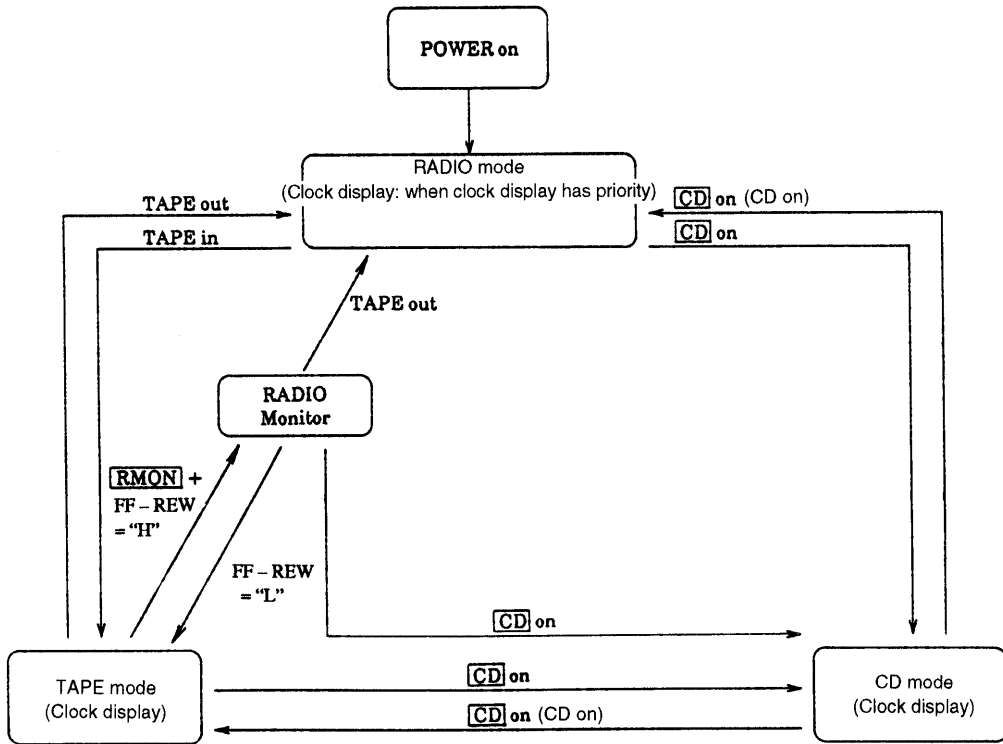

A02450

3. VF Mode, Clock Disabled

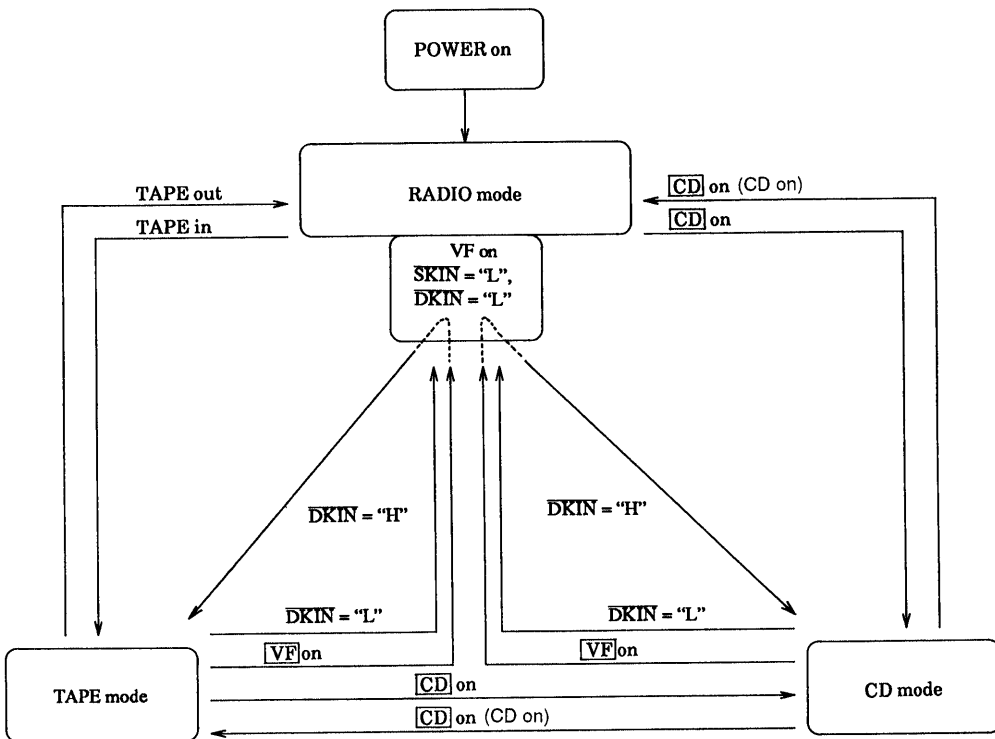

A02451

Note: The radio monitor transitions have been omitted.

4. VF Mode, Clock Enabled

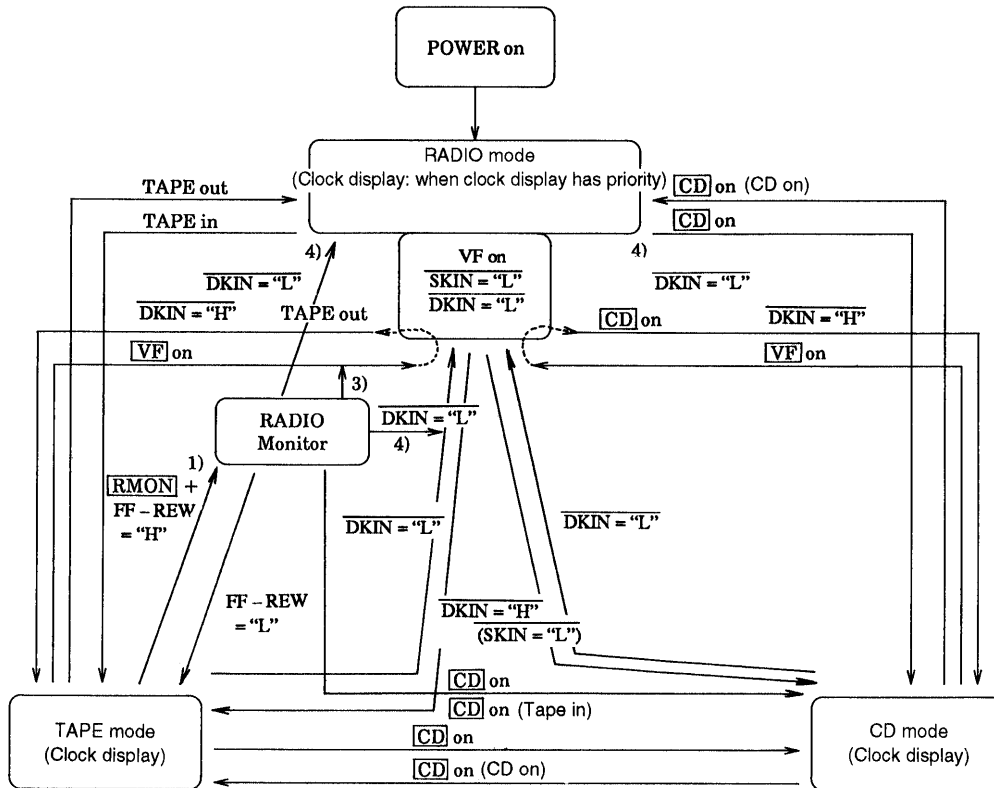

A02462

- Note: 1. Keys are indicated in boxes. However, note that when FF-REW is high (+ **RMON** is on: based on the diode matrix RMON FF-REW setting) the LC7233N-8818 goes to radio monitor mode.
 2. **CD on** operates identically when **CDIN** is low.
 3. If VF is switched from off to on during radio monitor mode, radio monitor mode is cleared and the LC7233N-8818 switches to VF mode.
 4. If **DKIN** goes low during radio monitor mode, radio monitor mode is cleared and SK broadcast begins.

Timing

1. T-UP/DOWN, SEEK, SCAN

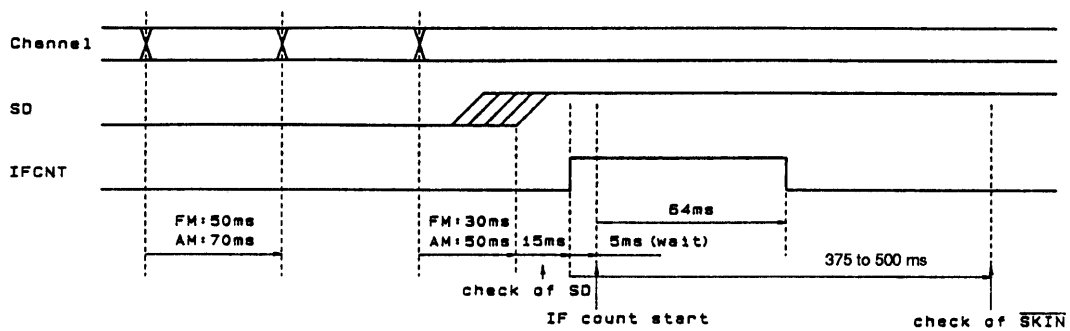

A02463

Note: 1. IF count tolerance

FM	10.7 MHz ± 10 kHz
MW	450 kHz ± 3 kHz
LW	450 kHz ± 0.6 kHz

2. An SD check is performed for 10 ms if IF count is enabled, and for 15 ms if IF count is disabled.

2. Manual Up/Down (both FM and AM)

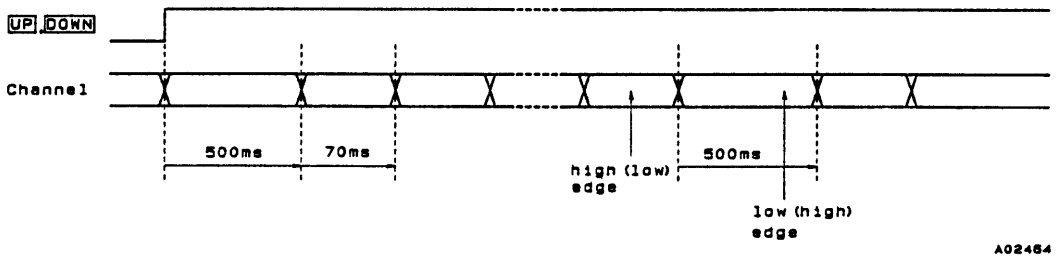

A02464

3. VF Auto-Retune

The LC7233N-8818 retunes with the following timing if a high level on $\overline{\text{SKIN}}$ continues for more than 25 seconds in VF mode.

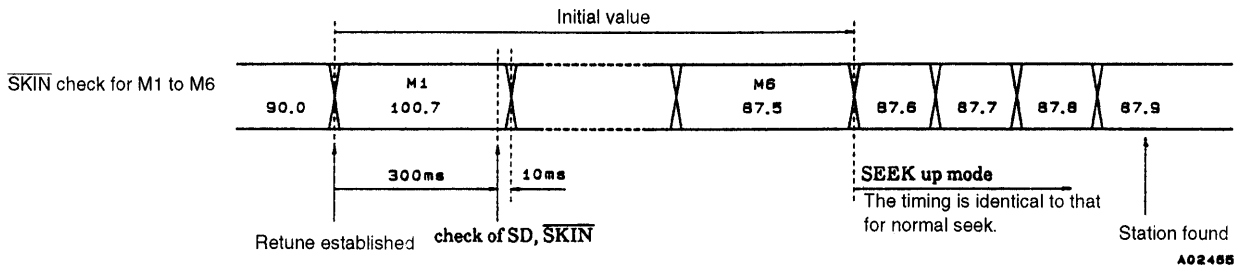

A02465

Note: 1. The timing for the VF preset memory search technique is shown in the figure below.

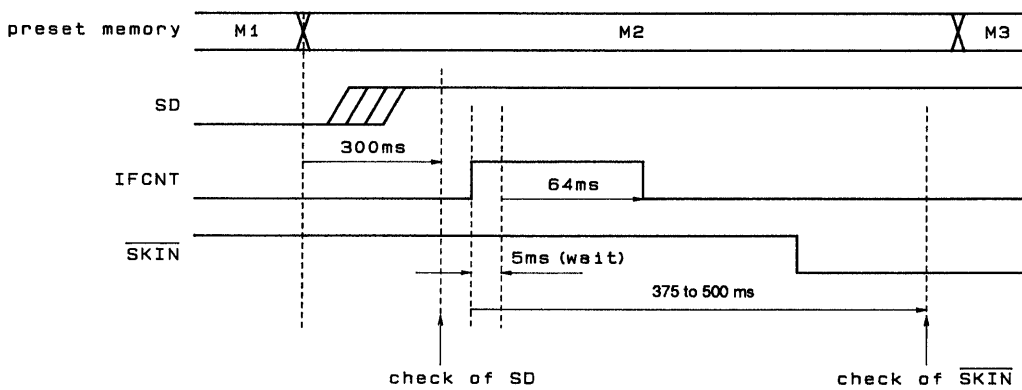

A02466

2. If there is no SD in a VF preset memory, a normal VF seek up operation is performed with timing identical to (1) above.

4. LOC Pin Control

SEEK, SCAN, AMEM and VF auto-retune operations when the LOC display is lit.

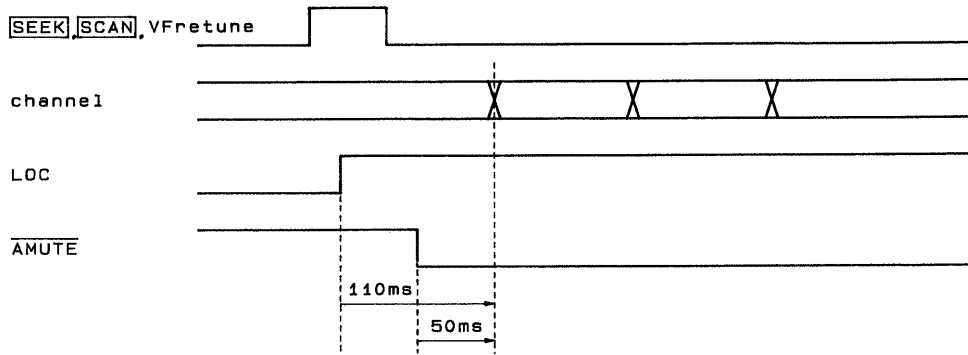

A02467

5. $\overline{\text{SKIN}}$ check timing when VF mode is switched from off to on

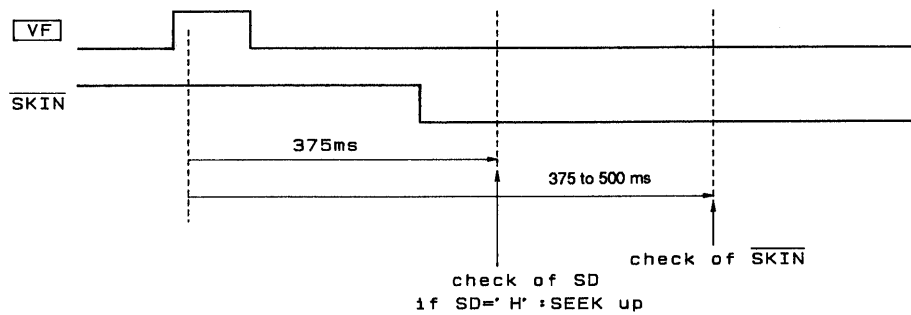

A02468

6. Audio Mute ($\overline{\text{AMUTE}}$)

- ① Key chattering rejection time (40 ms)
- ② Audio mute lead time and beep output (50 ms)
- ③ PLL data and display update processing (30 to 50 ms)
- ④ Audio mute trailing time

- BAND and M1 to M6 keys, and a VF on to off transition

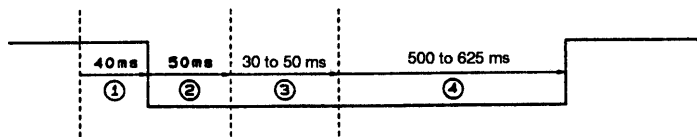

A02469

- VF off to on transition (except for times when DK is disabled, $\overline{\text{TAPE}}$ or $\overline{\text{CDIN}}$ are low, or CD is on)

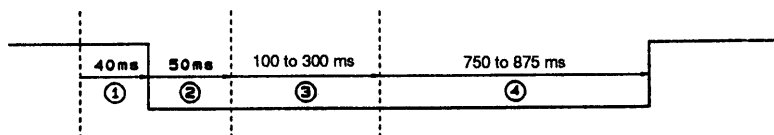

A02470

Note: Item ③ includes checking the $\overline{\text{SKIN}}$ signal.

- UP, DOWN

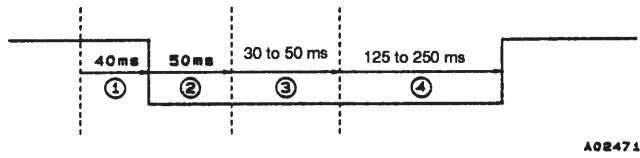

- PS (preset scan)

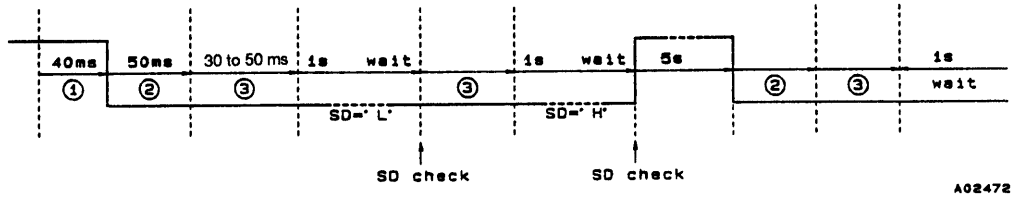

- AMEM, T-UP/DOWN, SEEK, SCAN

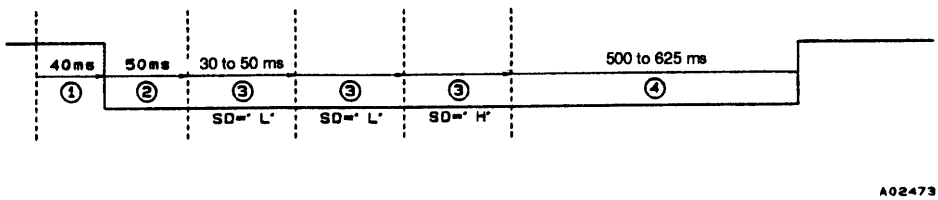

- VF auto retune

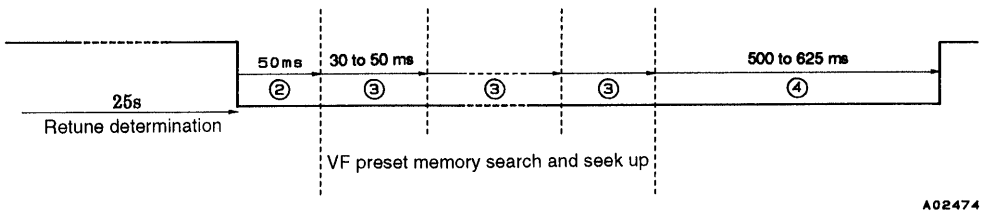

Note: $\overline{\text{AMUTE}}$ is not output for (a) through (f) when DK is disabled, $\overline{\text{TAPE}}$ or $\overline{\text{CDIN}}$ is low, or CD is on. However, $\overline{\text{AMUTE}}$ is output during a band switch in (a).

7. Mode Changes

- For each mode, when:
 - RADIO on
 - RADIO monitor on/off
 - TAPE in/out
 - $\overline{\text{CD}}$ on/off
 - $\text{CDIN} = \text{'H'} \rightarrow \text{'L'} \rightarrow \text{'H'}$

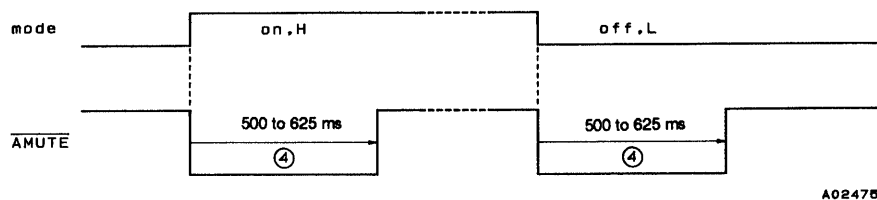

- VF off to on (tape and CD in modes)

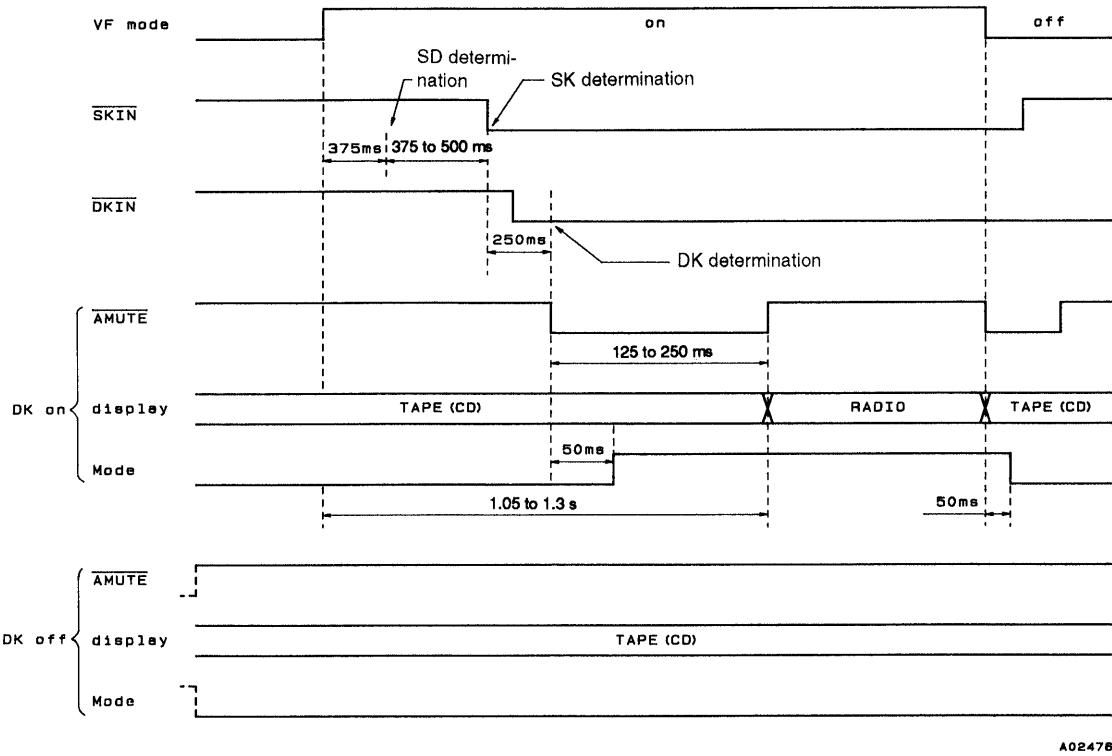

8. Allowable Scan Direction Display Timing

SK display based on $\overline{\text{SKIN}}$ and ST display based on $\overline{\text{STEREO}}$ in FM radio also valid in AM radio mode when the diode matrix AMST SEL setting is 1 and VF modes.

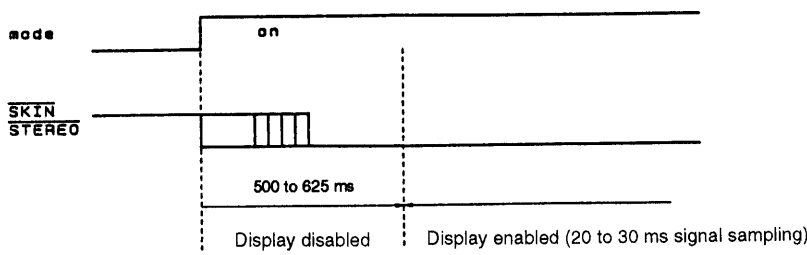

9. ALARM Output (VF mode)

If a high level $\overline{\text{SKIN}}$ signal continues for 25 seconds, an alarm signal (the sum of (approximately) 4.4 kHz and (approximately) 2 Hz signals) is output, and a seek up operation is started.

(When the diode matrix VF AUTORETUNE setting is 0.)

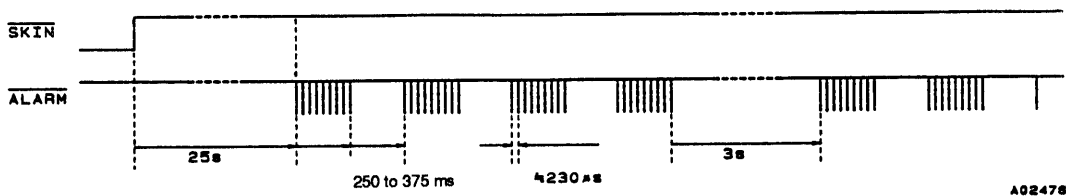

10. Beep Output

A beep is output for keys that have two functions (M1 to M6, LOUD/RMON, UP/T-UP, DOWN/T-DOWN, V-UP, V-DOWN, BAND/ILL1 and PS/AMEM) so that the user can recognize which key was pressed. The beep is output once (for presses less than 0.5, 1.5 or 2.0 seconds) or twice (for presses longer than 0.5, 1.5 or 2.0 seconds).

- One beep

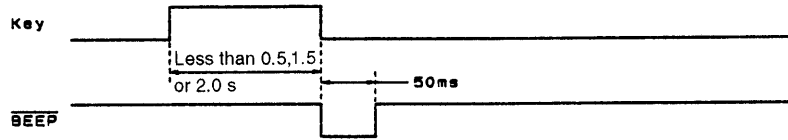

- Two beeps

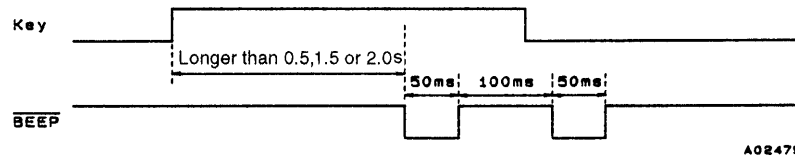

A02479

11. Hold Mode

When the clock is enabled and $\overline{\text{HOLD}}$ pin goes from high to low, inputs from the FMIN, AMIN and HCTR pins are disabled. The LC7233N-8818 enters a state where only the clock operates. This is referred to as hold mode.

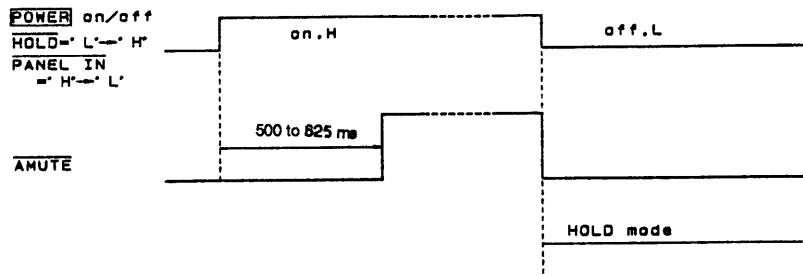

A02480

12. Backup Mode

When the clock is disabled and the $\overline{\text{HOLD}}$ pin goes from high to low, inputs from the FMIN, AMIN and HCTR pins are disabled, the 4.5 MHz crystal oscillator is stopped, and the LC7233N-8818 enters low power mode. This is referred to as backup mode.

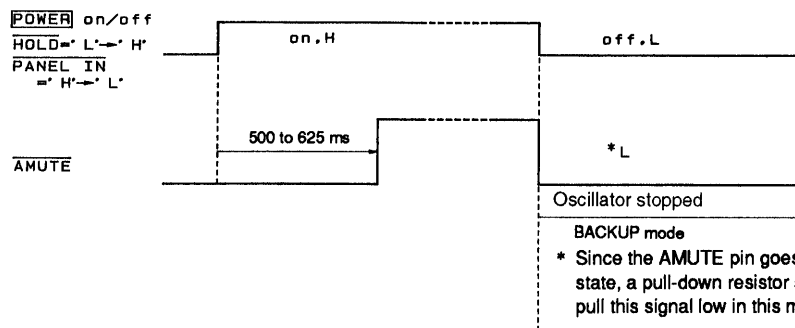

* Since the AMUTE pin goes to the high impedance state, a pull-down resistor should be connected to pull this signal low in this mode.

A02481

13. Timings when Detached

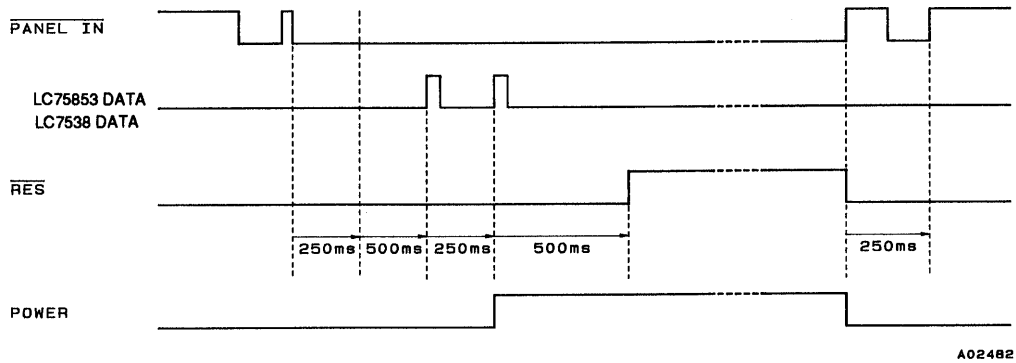

A02482

Note: Display data is transferred twice when the LC7233N-8818 is first brought up, and thereafter only when changed by some operation.

- When a power key is used, i.e., the diode matrix POWER SW setting is 1
If the panel is removed and replaced in the power on state, the power is turned off.
- When an external power switch is used, i.e., when the diode matrix POWER SW setting is 0
If the panel is removed and replaced in the power on state, the power remains on.

Initial States

RADIO mode	TAPE mode	POWER on, HOLD = 'H' (PANEL IN = 'L')
<ul style="list-style-type: none"> • BandFM1 (low band edge) • MO/STstereo • VFoff • LOCDX (off) 	<ul style="list-style-type: none"> • NR B, NR Coff • APSoff • MTLoff 	<ul style="list-style-type: none"> • Volume setting.....-50 dB • CD off • LOUDoff • RADIO monitoroff • MUTE off 'L' • ILL1 'L' • ILL2 'H'

Tracking Point Frequency

Area	Band	M1	M2	M3	M4	M5	M6	Last channel
USA	FM a, b	87.5	90.1	98.1	106.1	87.5	87.5	87.5
	MW a	530	600	1000	1400	530	530	530
	MW b	530	600	1000	1400	530	530	530
Southeast Asia	FM c	87.5	90.0	98.0	106.0	87.5	87.5	87.5
	MW h	531	603	999	1404	531	531	531
Europe	FM c, d	87.5	90.0	98.0	106.0	87.5	87.5	87.5
	MW c	531	603	999	1404	531	531	531
	LW a	153	160	200	260	153	153	153
	LW b	146	160	200	260	146	146	146
Japan	FM e	76.0	78.6	83.0	86.6	76.0	76.0	76.0
	MW e	522	603	999	1404	522	522	522
Saudi Arabia	FM b	87.5	90.1	98.1	106.1	87.5	87.5	87.5
	MW f	531	603	999	1404	531	531	531
South Africa	FM f	87.5	90.1	98.1	106.1	87.5	87.5	87.5
	MW g	531	603	999	1404	531	531	531
East Europe	FM g	65.0	74.0	87.5	94.0	65.0	65.0	65.0
	MWc	531	603	999	1404	531	531	531

Note: 1. FM2, FM3 and MW2 load the lower band edge.
2. In Eastern Europe, FM2 and FM3 load 87.5 MHz.

LC7233N-8818 Detachable System

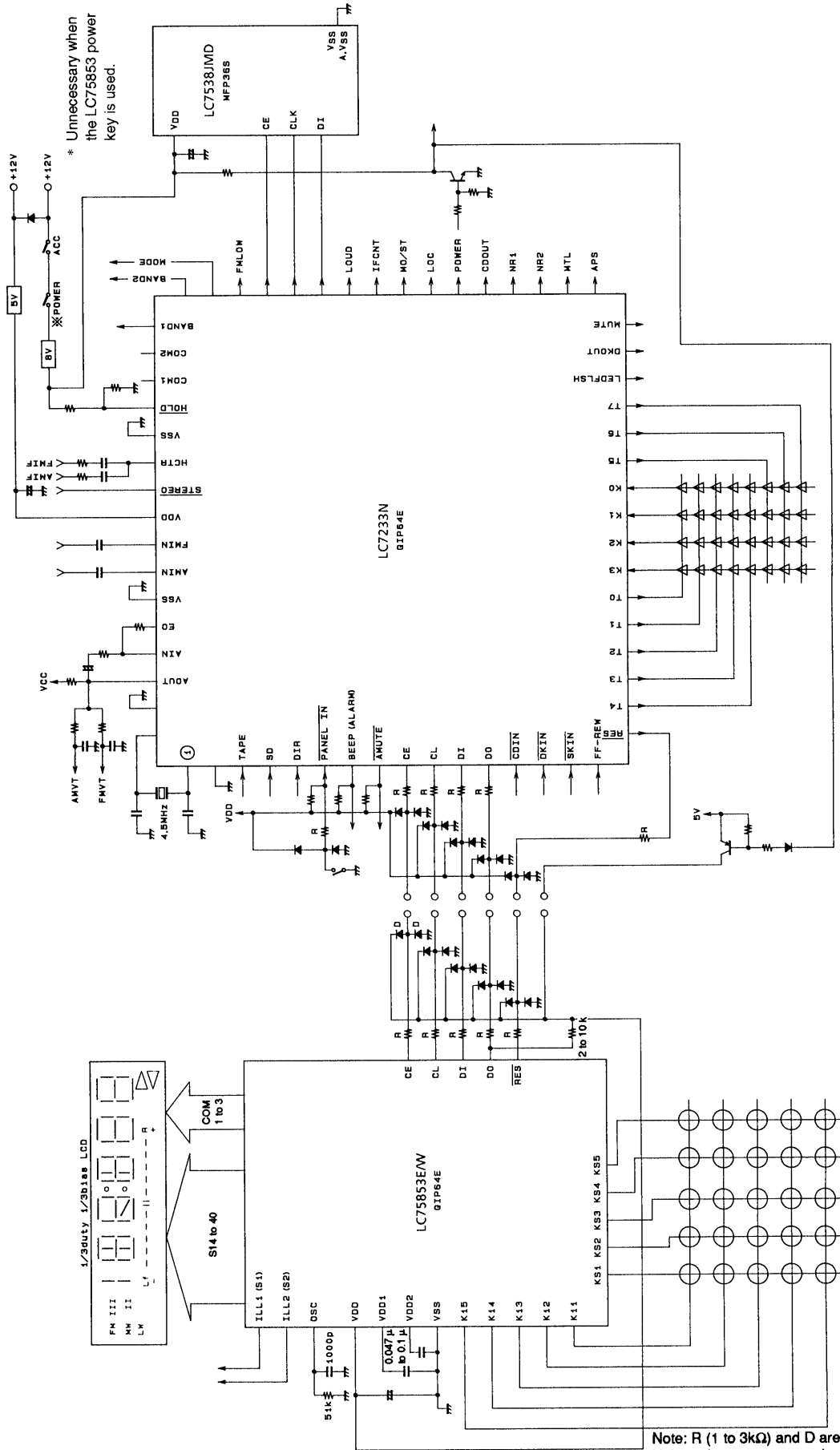

A02-83

- No products described or contained herein are intended for use in surgical implants, life-support systems, aerospace equipment, nuclear power control systems, vehicles, disaster/crime-prevention equipment and the like, the failure of which may directly or indirectly cause injury, death or property loss.
- Anyone purchasing any products described or contained herein for an above-mentioned use shall:
 - ① Accept full responsibility and indemnify and defend SANYO ELECTRIC CO., LTD., its affiliates, subsidiaries and distributors and all their officers and employees, jointly and severally, against any and all claims and litigation and all damages, cost and expenses associated with such use:
 - ② Not impose any responsibility for any fault or negligence which may be cited in any such claim or litigation on SANYO ELECTRIC CO., LTD., its affiliates, subsidiaries and distributors or any of their officers and employees jointly or severally.
- Information (including circuit diagrams and circuit parameters) herein is for example only; it is not guaranteed for volume production. SANYO believes information herein is accurate and reliable, but no guarantees are made or implied regarding its use or any infringements of intellectual property rights or other rights of third parties.

This catalog provides information as of July, 1995. Specifications and information herein are subject to change without notice.