

PolarHV™ HiPerFET Power MOSFET

IXFK 44N80P
IXFX 44N80P

$$\begin{aligned} V_{DSS} &= 800 \text{ V} \\ I_{D25} &= 44 \text{ A} \\ R_{DS(on)} &\leq 190 \text{ m}\Omega \\ t_{rr} &\leq 250 \text{ ns} \end{aligned}$$

N-Channel Enhancement Mode
Avalanche Rated
Fast Intrinsic Diode

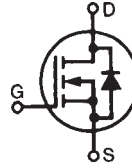

Symbol	Test Conditions	Maximum Ratings	
V_{DSS}	$T_J = 25^\circ\text{C}$ to 150°C	800	V
V_{DGR}	$T_J = 25^\circ\text{C}$ to 150°C ; $R_{GS} = 1 \text{ M}\Omega$	800	V
V_{GS}	Continuous	± 30	V
V_{GSM}	Transient	± 40	V
I_{D25}	$T_C = 25^\circ\text{C}$	44	A
I_{DM}	$T_C = 25^\circ\text{C}$, pulse width limited by T_{JM}	100	A
I_{AR}	$T_C = 25^\circ\text{C}$	22	A
E_{AR}	$T_C = 25^\circ\text{C}$	80	mJ
E_{AS}	$T_C = 25^\circ\text{C}$	3.4	J
dv/dt	$I_S \leq I_{DM}$, $di/dt \leq 100 \text{ A}/\mu\text{s}$, $V_{DD} \leq V_{DSS}$, $T_J \leq 150^\circ\text{C}$, $R_G = 10 \Omega$	10	V/ns
P_D	$T_C = 25^\circ\text{C}$	1040	W
T_J		-55 ... +150	$^\circ\text{C}$
T_{JM}		150	$^\circ\text{C}$
T_{stg}		-55 ... +150	$^\circ\text{C}$
T_L	1.6 mm (0.062 in.) from case for 10 s	300	$^\circ\text{C}$
T_{SOLD}	Plastic body for 10 s	260	$^\circ\text{C}$
M_d	Mounting torque (IXFK)	1.13.10	Nm/lb.in.
F_c	Mounting force (IXFX)	20..120 / 4.5..25	N/lb
Weight	(IXFK)	10	g
	(IXFX)	5	g

TO-264 (IXFK)

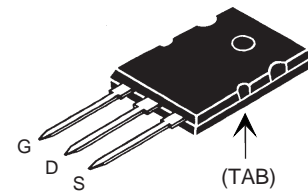

PLUS247 (IXFX)

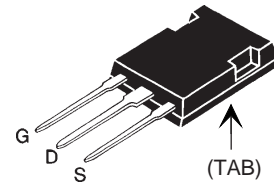

G = Gate D = Drain
S = Source TAB = Drain

Features

- Fast intrinsic diode
- International standard packages
- Unclamped Inductive Switching (UIS) rated
- Low package inductance
 - easy to drive and to protect

Advantages

- Easy to mount
- Space savings
- High power density

Symbol	Test Conditions ($T_J = 25^\circ\text{C}$ unless otherwise specified)	Characteristic Values		
		Min.	Typ.	Max.
BV_{DSS}	$V_{GS} = 0 \text{ V}$, $I_D = 800 \mu\text{A}$	800		V
$V_{GS(th)}$	$V_{DS} = V_{GS}$, $I_D = 8 \text{ mA}$	3.0		5.0 V
I_{GSS}	$V_{GS} = \pm 30 \text{ V}_{DC}$, $V_{DS} = 0$			$\pm 200 \text{ nA}$
I_{DSS}	$V_{DS} = V_{DSS}$			50 μA
	$V_{GS} = 0 \text{ V}$ $T_J = 125^\circ\text{C}$			1.5 mA
$R_{DS(on)}$	$V_{GS} = 10 \text{ V}$, $I_D = 0.5 I_{D25}$, Note 1			190 $\text{m}\Omega$

Symbol	Test Conditions	Characteristic Values ($T_J = 25^\circ\text{C}$ unless otherwise specified)		
		Min.	Typ.	Max.
g_{fs}	$V_{DS} = 20\text{ V}; I_D = 0.5 I_{D25}$, Note 1	27	43	S
C_{iss}	$V_{GS} = 0\text{ V}, V_{DS} = 25\text{ V}, f = 1\text{ MHz}$		12	nF
C_{oss}			910	pF
C_{rss}			30	pF
$t_{d(on)}$	$V_{GS} = 10\text{ V}, V_{DS} = 0.5 V_{DSS}, I_D = I_{D25}$ $R_G = 1\ \Omega$ (External)		28	ns
t_r			22	ns
$t_{d(off)}$			75	ns
t_f			27	ns
$Q_{g(on)}$	$V_{GS} = 10\text{ V}, V_{DS} = 0.5 V_{DSS}, I_D = 0.5 I_{D25}$		198	nC
Q_{gs}			67	nC
Q_{gd}			65	nC
R_{thJC}				0.12°C/W
R_{thCS}		0.15		$^\circ\text{C/W}$

Source-Drain Diode

Symbol	Test Conditions	Characteristic Values ($T_J = 25^\circ\text{C}$ unless otherwise specified)		
		Min.	Typ.	Max.
I_s	$V_{GS} = 0\text{ V}$			44 A
I_{SM}	Repetitive			100 A
V_{SD}	$I_F = I_s, V_{GS} = 0\text{ V}$, Note 1			1.5 V
t_{rr}	$I_F = 22\text{ A}, -di/dt = 100\text{ A}/\mu\text{s}$			250 ns
Q_{RM}		$V_R = 100\text{ V}, V_{GS} = 0\text{ V}$		0.8
I_{RM}				8.0

Note 1: Pulse test, $t \leq 300\ \mu\text{s}$, duty cycle $d \leq 2\%$

TO-264 (IXFK) Outline

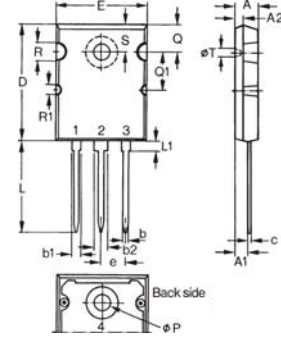

Dim.	Millimeter		Inches	
	Min.	Max.	Min.	Max.
A	4.82	5.13	.190	.202
A1	2.54	2.89	.100	.114
A2	2.00	2.10	.079	.083
b	1.12	1.42	.044	.056
b1	2.39	2.69	.094	.106
b2	2.90	3.09	.114	.122
c	0.53	0.83	.021	.033
D	25.91	26.16	1.020	1.030
E	19.81	19.96	.780	.786
e	5.46 BSC		.215 BSC	
J	0.00	0.25	.000	.010
K	0.00	0.25	.000	.010
L	20.32	20.83	.800	.820
L1	2.29	2.59	.090	.102
P	3.17	3.66	.125	.144
Q	6.07	6.27	.239	.247
Q1	8.38	8.69	.330	.342
R	3.81	4.32	.150	.170
R1	1.78	2.29	.070	.090
S	6.04	6.30	.238	.248
T	1.57	1.83	.062	.072

PLUS 247™ (IXFX) Outline

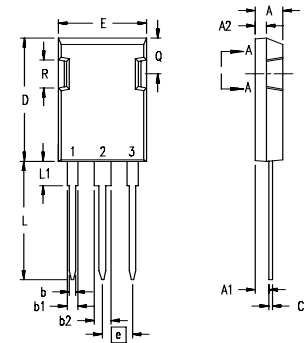

Terminals: 1 - Gate
2 - Drain (Collector)
3 - Source (Emitter)
4 - Drain (Collector)

Dim.	Millimeter		Inches	
	Min.	Max.	Min.	Max.
A	4.83	5.21	.190	.205
A ₁	2.29	2.54	.090	.100
A ₂	1.91	2.16	.075	.085
b	1.14	1.40	.045	.055
b ₁	1.91	2.13	.075	.084
b ₂	2.92	3.12	.115	.123
C	0.61	0.80	.024	.031
D	20.80	21.34	.819	.840
E	15.75	16.13	.620	.635
e	5.45 BSC		.215 BSC	
L	19.81	20.32	.780	.800
L1	3.81	4.32	.150	.170
Q	5.59	6.20	.220	0.244
R	4.32	4.83	.170	.190

IXYS reserves the right to change limits, test conditions, and dimensions.

IXYS MOSFETs and IGBTs are covered by one or more of the following U.S. patents:

4,835,592	4,931,844	5,049,961	5,237,481	6,162,665	6,404,065 B1	6,683,344	6,727,585
4,850,072	5,017,508	5,063,307	5,381,025	6,259,123 B1	6,534,343	6,710,405B2	6,759,692
4,881,106	5,034,796	5,187,117	5,486,715	6,306,728 B1	6,583,505	6,710,463	6,771,478 B2

**Fig. 1. Output Characteristics
@ 25°C**

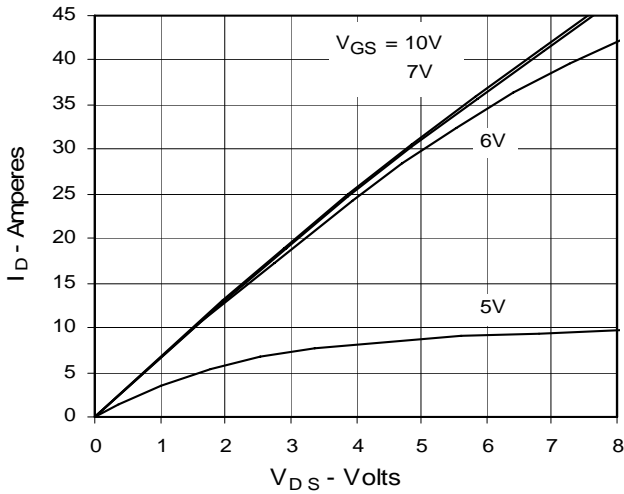

**Fig. 2. Extended Output Characteristics
@ 25°C**

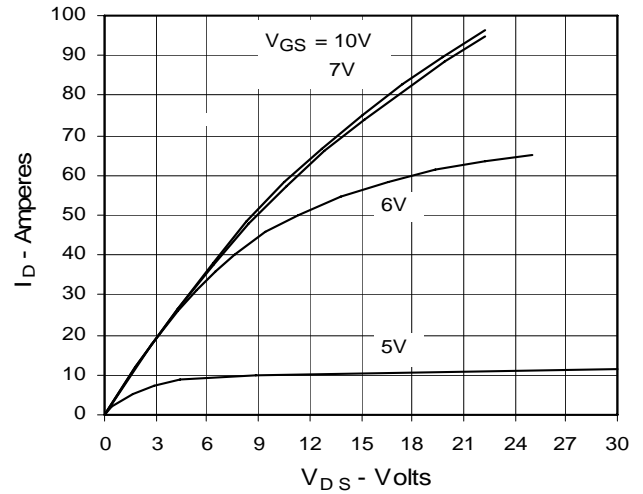

**Fig. 3. Output Characteristics
@ 125°C**

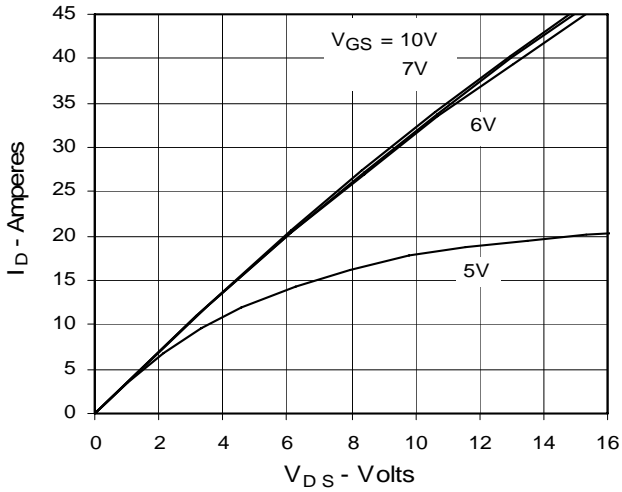

**Fig. 4. $R_{DS(on)}$ Normalized to 0.5 I_{D25}
Value vs. Junction Temperature**

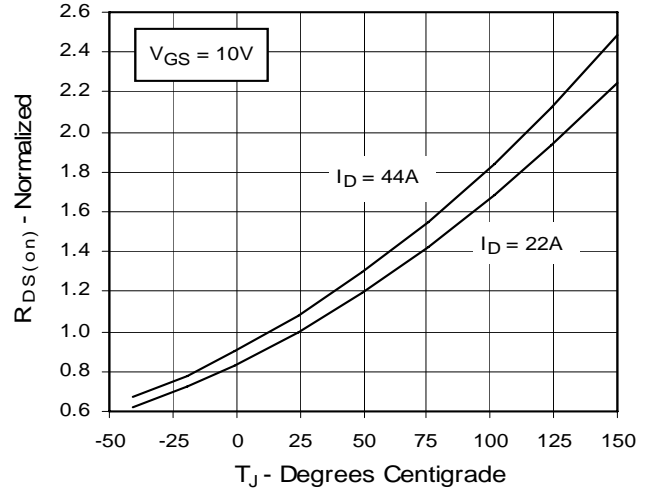

**Fig. 5. $R_{DS(on)}$ Normalized to 0.5 I_{D25}
Value vs. Drain Current**

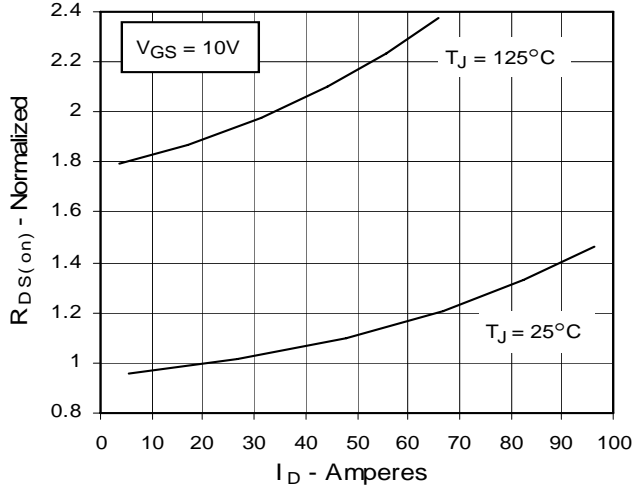

Fig. 6. Drain Current vs. Case Temperature

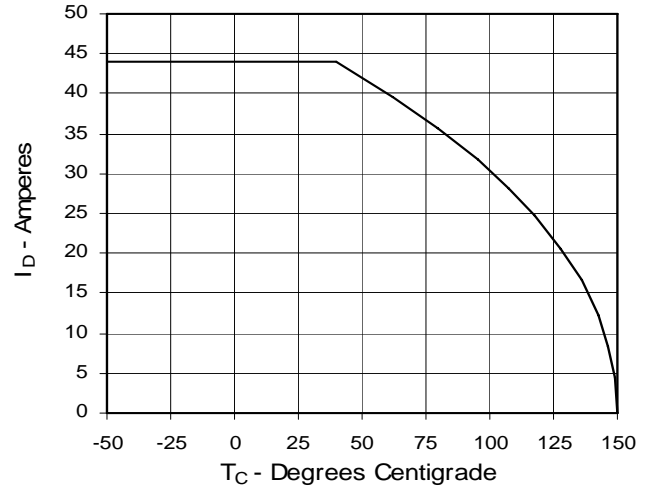

Fig. 7. Input Admittance

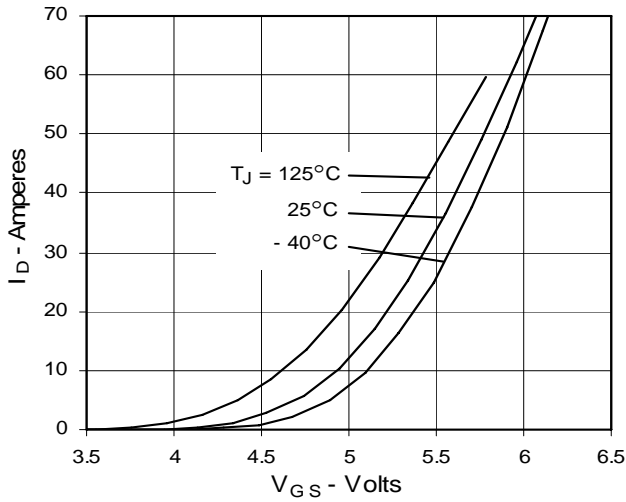

Fig. 8. Transconductance

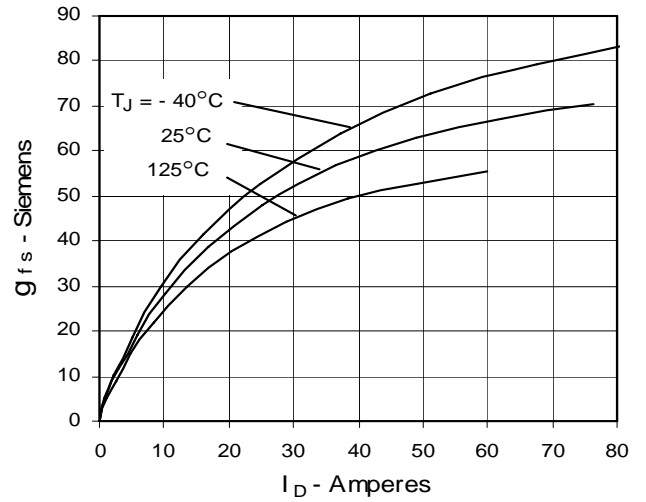

Fig. 9. Source Current vs. Source-To-Drain Voltage

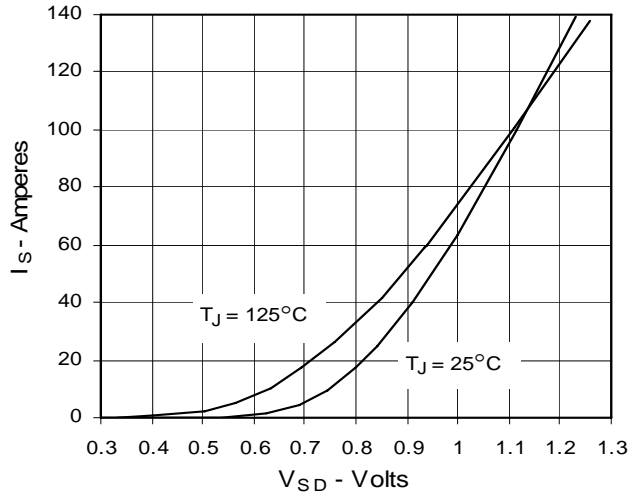

Fig. 10. Gate Charge

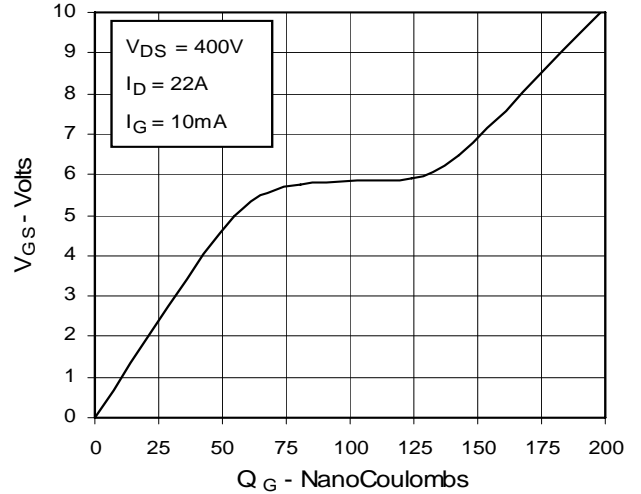

Fig. 11. Capacitance

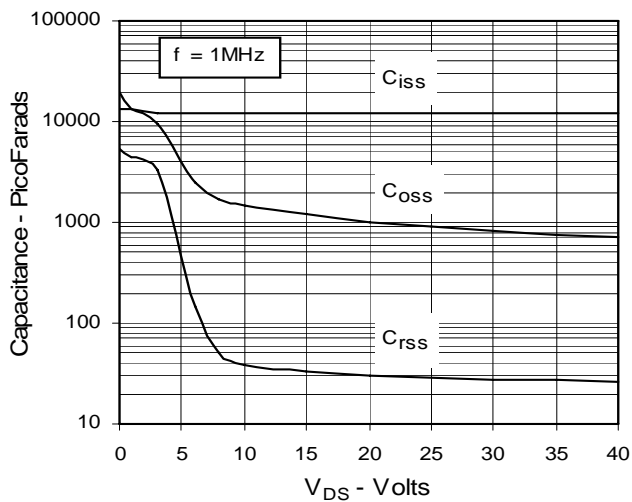

Fig. 13. Maximum Transient Thermal Resistance

