

### FEATURES

#### Fully differential

#### Extremely low power with power-down feature

2.6 mA quiescent supply current @ 5 V

450  $\mu$ A in power-down mode @ 5 V

#### High speed

110 MHz large signal 3 dB bandwidth @ G = 1

450 V/ $\mu$ s slew rate

#### 12-bit SFDR performance @ 500 kHz

#### Fast settling time: 100 ns to 0.02%

#### Low input offset voltage: $\pm 2.6$ mV max

#### Low input offset current: 0.45 $\mu$ A max

#### Differential input and output

#### Differential-to-differential or single-ended-to-differential operation

#### Rail-to-rail output

#### Adjustable output common-mode voltage

#### Externally adjustable gain

#### Wide supply voltage range: 2.7 V to 12 V

#### Available in small SOIC package

### APPLICATIONS

#### 12-bit ADC drivers

#### Portable instrumentation

#### Battery-powered applications

#### Single-ended-to-differential converters

#### Differential active filters

#### Video amplifiers

#### Level shifters

### GENERAL DESCRIPTION

The AD8137 is a low cost differential driver with a rail-to-rail output that is ideal for driving 12-bit ADCs in systems that are sensitive to power and cost. The AD8137 is easy to apply, and its internal common-mode feedback architecture allows its output common-mode voltage to be controlled by the voltage applied to one pin. The internal feedback loop also provides inherently balanced outputs as well as suppression of even-order harmonic distortion products. Fully differential and single-ended-to-differential gain configurations are easily realized by the AD8137. External feedback networks consisting of four resistors determine the amplifier's closed-loop gain. The power-down feature is beneficial in critical low power applications.

#### Rev. A

Information furnished by Analog Devices is believed to be accurate and reliable. However, no responsibility is assumed by Analog Devices for its use, nor for any infringements of patents or other rights of third parties that may result from its use. Specifications subject to change without notice. No license is granted by implication or otherwise under any patent or patent rights of Analog Devices. Trademarks and registered trademarks are the property of their respective owners.

### FUNCTIONAL BLOCK DIAGRAM

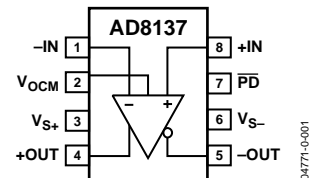

Figure 1.

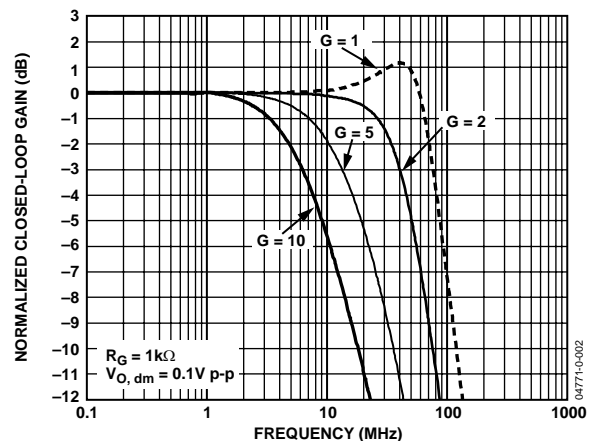

Figure 2. Small Signal Response for Various Gains

The AD8137 is manufactured on Analog Devices' proprietary second generation XFCB process, enabling it to achieve high levels of performance with very low power consumption.

The AD8137 is available in the small 8-lead SOIC package and 3 mm  $\times$  3 mm LFCSP. It is rated to operate over the extended industrial temperature range of  $-40^{\circ}\text{C}$  to  $+125^{\circ}\text{C}$ .

**TABLE OF CONTENTS**

Specifications..... 3

Absolute Maximum Ratings..... 6

    Thermal Resistance ..... 6

    ESD Caution..... 6

Pin Configuration and Function Descriptions..... 7

Typical Performance Characteristics ..... 8

Theory of Operation ..... 17

Applications..... 18

    Analyzing a Typical Application with Matched  $R_F$  and  $R_G$  Networks..... 18

    Estimating Noise, Gain, and Bandwidth with Matched Feedback Networks ..... 18

    Driving an ADC with Greater Than 12-Bit Performance..... 22

Outline Dimensions ..... 24

Ordering Guide..... 24

**REVISION HISTORY**

**8/04—Data Sheet Changed from a Rev. 0 to Rev. A.**

Added 8-Lead LFCSP..... Universal

Changes to Layout..... Universal

Changes to Product Title..... 1

Changes to Figure 1..... 1

Changes to Specifications..... 3

Changes to Absolute Maximum Ratings ..... 6

Changes to Figure 4 and Figure 5..... 7

Added Figure 6, Figure 20, Figure 23, Figure 35, Figure 48, and Figure 58; Renumbered Successive Figures..... 7

Changes to Figure 32..... 12

Changes to Figure 40..... 13

Changes to Figure 55..... 16

Changes to Table 7 and Figure 63..... 18

Changes to Equation 19..... 19

Changes to Figure 64 and Figure 65..... 20

Changes to Figure 66..... 22

Added Driving an ADC with Greater Than 12-Bit Performance Section ..... 22

Changes to Ordering Guide ..... 24

Updated Outline Dimensions ..... 24

**5/04—Revision 0: Initial Version**

## SPECIFICATIONS

**Table 1.**  $V_S = \pm 5\text{ V}$ ,  $V_{OCM} = 0\text{ V}$  (@  $25^\circ\text{C}$ , Diff. Gain = 1,  $R_{L, dm} = R_F = R_G = 1\text{ k}\Omega$ , unless otherwise noted,  $T_{MIN}$  to  $T_{MAX} = -40^\circ\text{C}$  to  $+125^\circ\text{C}$ )

Parameter	Conditions	Min	Typ	Max	Unit
DIFFERENTIAL INPUT PERFORMANCE					
DYNAMIC PERFORMANCE					
-3 dB Small Signal Bandwidth	$V_{O, dm} = 0.1\text{ V p-p}$	64	76		MHz
-3 dB Large Signal Bandwidth	$V_{O, dm} = 2\text{ V p-p}$	79	110		MHz
Slew Rate	$V_{O, dm} = 2\text{ V Step}$		450		V/ $\mu\text{s}$
Settling Time to 0.02%	$V_{O, dm} = 3.5\text{ V Step}$		100		ns
Overdrive Recovery Time	$G = 2$ , $V_{I, dm} = 12\text{ V p-p Triangle Wave}$		85		ns
NOISE/HARMONIC PERFORMANCE					
SFDR	$V_{O, dm} = 2\text{ V p-p}$ , $f_c = 500\text{ kHz}$		90		dB
	$V_{O, dm} = 2\text{ V p-p}$ , $f_c = 2\text{ MHz}$		76		dB
Input Voltage Noise	$f = 50\text{ kHz to }1\text{ MHz}$		8.25		nV/ $\sqrt{\text{Hz}}$
Input Current Noise	$f = 50\text{ kHz to }1\text{ MHz}$		1		pA/ $\sqrt{\text{Hz}}$
DC PERFORMANCE					
Input Offset Voltage	$V_{IP} = V_{IN} = V_{OCM} = 0\text{ V}$	-2.6	$\pm 0.7$	+2.6	mV
Input Offset Voltage Drift	$T_{MIN}$ to $T_{MAX}$		3		$\mu\text{V}/^\circ\text{C}$
Input Bias Current	$T_{MIN}$ to $T_{MAX}$		0.5	1	$\mu\text{A}$
Input Offset Current			0.1	0.45	$\mu\text{A}$
Open-Loop Gain			91		dB
INPUT CHARACTERISTICS					
Input Common-Mode Voltage Range		-4		+4	V
Input Resistance	Differential		800		$\text{k}\Omega$
	Common-Mode		400		$\text{k}\Omega$
Input Capacitance	Common-Mode		1.8		pF
CMRR	$\Delta V_{ICM} = \pm 1\text{ V}$	66	79		dB
OUTPUT CHARACTERISTICS					
Output Voltage Swing	Each Single-Ended Output, $R_{L, dm} = 1\text{ k}\Omega$	$V_{S-} + 0.55$		$V_{S+} - 0.55$	V
Output Current			20		mA
Output Balance Error	$f = 1\text{ MHz}$		-64		dB
$V_{OCM}$ to $V_{O, cm}$ PERFORMANCE					
$V_{OCM}$ DYNAMIC PERFORMANCE					
-3 dB Bandwidth	$V_{O, cm} = 0.1\text{ V p-p}$		58		MHz
Slew Rate	$V_{O, cm} = 0.5\text{ V p-p}$		63		V/ $\mu\text{s}$
Gain		0.992	1.000	1.008	V/V
$V_{OCM}$ INPUT CHARACTERISTICS					
Input Voltage Range		-4		+4	V
Input Resistance			35		$\text{k}\Omega$
Input Offset Voltage		-28	$\pm 11$	+28	mV
Input Voltage Noise	$f = 100\text{ kHz to }1\text{ MHz}$		18		nV/ $\sqrt{\text{Hz}}$
Input Bias Current			0.3	1.1	$\mu\text{A}$
CMRR	$\Delta V_{O, dm}/\Delta V_{OCM}$ , $\Delta V_{OCM} = \pm 0.5\text{ V}$	62	75		dB
POWER SUPPLY					
Operating Range		+2.7		$\pm 6$	V
Quiescent Current			3.2	3.6	mA
Quiescent Current, Disabled	Power-Down = Low		750	900	$\mu\text{A}$
PSRR	$\Delta V_S = \pm 1\text{ V}$	79	91		dB
PD PIN					
Threshold Voltage		$V_{S-} + 0.7$		$V_{S-} + 1.7$	V
Input Current	Power-Down = High/Low		150/210	170/240	$\mu\text{A}$
OPERATING TEMPERATURE RANGE					
		-40		+125	$^\circ\text{C}$

# AD8137

**Table 2.**  $V_S = 5\text{ V}$ ,  $V_{OCM} = 2.5\text{ V}$  (@  $25^\circ\text{C}$ , Diff. Gain = 1,  $R_{L, dm} = R_F = R_G = 1\text{ k}\Omega$ , unless otherwise noted,  $T_{MIN}$  to  $T_{MAX} = -40^\circ\text{C}$  to  $+125^\circ\text{C}$ )

Parameter	Conditions	Min	Typ	Max	Unit
DIFFERENTIAL INPUT PERFORMANCE					
DYNAMIC PERFORMANCE					
-3 dB Small Signal Bandwidth	$V_{O, dm} = 0.1\text{ V p-p}$	63	75		MHz
-3 dB Large Signal Bandwidth	$V_{O, dm} = 2\text{ V p-p}$	76	107		MHz
Slew Rate	$V_{O, dm} = 2\text{ V Step}$		375		V/ $\mu\text{s}$
Settling Time to 0.02%	$V_{O, dm} = 3.5\text{ V Step}$		110		ns
Overdrive Recovery Time	$G = 2$ , $V_{i, dm} = 7\text{ V p-p Triangle Wave}$		90		ns
NOISE/HARMONIC PERFORMANCE					
SFDR	$V_{O, dm} = 2\text{ V p-p}$ , $f_c = 500\text{ kHz}$		89		dB
	$V_{O, dm} = 2\text{ V p-p}$ , $f_c = 2\text{ MHz}$		73		dB
Input Voltage Noise	$f = 50\text{ kHz to }1\text{ MHz}$		8.25		nV/ $\sqrt{\text{Hz}}$
Input Current Noise	$f = 50\text{ kHz to }1\text{ MHz}$		1		pA/ $\sqrt{\text{Hz}}$
DC PERFORMANCE					
Input Offset Voltage	$V_{IP} = V_{IN} = V_{OCM} = 0\text{ V}$	-2.7	$\pm 0.7$	+2.7	mV
Input Offset Voltage Drift	$T_{MIN}$ to $T_{MAX}$		3		$\mu\text{V}/^\circ\text{C}$
Input Bias Current	$T_{MIN}$ to $T_{MAX}$		0.5	0.9	$\mu\text{A}$
Input Offset Current			0.1	0.45	$\mu\text{A}$
Open-Loop Gain			89		dB
INPUT CHARACTERISTICS					
Input Common-Mode Voltage Range		1		4	V
Input Resistance	Differential		800		$\text{k}\Omega$
	Common-Mode		400		$\text{k}\Omega$
Input Capacitance	Common-Mode		1.8		pF
CMRR	$\Delta V_{ICM} = \pm 1\text{ V}$	64	90		dB
OUTPUT CHARACTERISTICS					
Output Voltage Swing	Each Single-Ended Output, $R_{L, dm} = 1\text{ k}\Omega$	$V_{S-} + 0.45$		$V_{S+} - 0.45$	V
Output Current			20		mA
Output Balance Error	$f = 1\text{ MHz}$		-64		dB
$V_{OCM}$ to $V_{O, cm}$ PERFORMANCE					
$V_{OCM}$ DYNAMIC PERFORMANCE					
-3 dB Bandwidth	$V_{O, cm} = 0.1\text{ V p-p}$		60		MHz
Slew Rate	$V_{O, cm} = 0.5\text{ V p-p}$		61		V/ $\mu\text{s}$
Gain		0.980	1.000	1.020	V/V
$V_{OCM}$ INPUT CHARACTERISTICS					
Input Voltage Range		1		4	V
Input Resistance			35		$\text{k}\Omega$
Input Offset Voltage		-25	$\pm 7.5$	+25	mV
Input Voltage Noise	$f = 100\text{ kHz to }5\text{ MHz}$		18		nV/ $\sqrt{\text{Hz}}$
Input Bias Current			0.25	0.9	$\mu\text{A}$
CMRR	$\Delta V_{O, dm} / \Delta V_{OCM}$ , $\Delta V_{OCM} = \pm 0.5\text{ V}$	62	75		dB
POWER SUPPLY					
Operating Range		+2.7		$\pm 6$	V
Quiescent Current			2.6	2.8	mA
Quiescent Current, Disabled	Power-Down = Low		450	600	$\mu\text{A}$
PSRR	$\Delta V_S = \pm 1\text{ V}$	79	91		dB
PD PIN					
Threshold Voltage		$V_{S-} + 0.7$		$V_{S-} + 1.5$	V
Input Current	Power-Down = High/Low		50/110	60/120	$\mu\text{A}$
OPERATING TEMPERATURE RANGE					
		-40		+125	$^\circ\text{C}$

Table 3.  $V_S = 3\text{ V}$ ,  $V_{OCM} = 1.5\text{ V}$  (@  $25^\circ\text{C}$ , Diff. Gain = 1,  $R_{L, dm} = R_F = R_G = 1\text{ k}\Omega$ , unless otherwise noted,  $T_{MIN}$  to  $T_{MAX} = -40^\circ\text{C}$  to  $+125^\circ\text{C}$ )

Parameter	Conditions	Min	Typ	Max	Unit
DIFFERENTIAL INPUT PERFORMANCE					
DYNAMIC PERFORMANCE					
-3 dB Small Signal Bandwidth	$V_{O, dm} = 0.1\text{ V p-p}$	61	73		MHz
-3 dB Large Signal Bandwidth	$V_{O, dm} = 2\text{ V p-p}$	62	93		MHz
Slew Rate	$V_{O, dm} = 2\text{ V Step}$		340		V/ $\mu\text{s}$
Settling Time to 0.02%	$V_{O, dm} = 3.5\text{ V Step}$		110		ns
Overdrive Recovery Time	$G = 2$ , $V_{l, dm} = 5\text{ V p-p Triangle Wave}$		100		ns
NOISE/HARMONIC PERFORMANCE					
SFDR	$V_{O, dm} = 2\text{ V p-p}$ , $f_c = 500\text{ kHz}$		89		dB
	$V_{O, dm} = 2\text{ V p-p}$ , $f_c = 2\text{ MHz}$		71		dB
Input Voltage Noise	$f = 50\text{ kHz to }1\text{ MHz}$		8.25		nV/ $\sqrt{\text{Hz}}$
Input Current Noise	$f = 50\text{ kHz to }1\text{ MHz}$		1		pA/ $\sqrt{\text{Hz}}$
DC PERFORMANCE					
Input Offset Voltage	$V_{IP} = V_{IN} = V_{OCM} = 0\text{ V}$	-2.75	$\pm 0.7$	+2.75	mV
Input Offset Voltage Drift	$T_{MIN}$ to $T_{MAX}$		3		$\mu\text{V}/^\circ\text{C}$
Input Bias Current	$T_{MIN}$ to $T_{MAX}$		0.5	0.9	$\mu\text{A}$
Input Offset Current			0.1	0.4	$\mu\text{A}$
Open-Loop Gain			87		dB
INPUT CHARACTERISTICS					
Input Common-Mode Voltage Range		1		2	V
Input Resistance	Differential		800		$\text{M}\Omega$
	Common-Mode		400		$\text{M}\Omega$
Input Capacitance	Common-Mode		1.8		pF
CMRR	$\Delta V_{ICM} = \pm 1\text{ V}$	64	80		dB
OUTPUT CHARACTERISTICS					
Output Voltage Swing	Each Single-Ended Output, $R_{L, dm} = 1\text{ k}\Omega$	$V_{S-} + 0.37$		$V_{S+} - 0.37$	V
Output Current			20		mA
Output Balance Error	$f = 1\text{ MHz}$		-64		dB
$V_{OCM}$ to $V_{O, cm}$ PERFORMANCE					
$V_{OCM}$ DYNAMIC PERFORMANCE					
-3 dB Bandwidth	$V_{O, cm} = 0.1\text{ V p-p}$		61		MHz
Slew Rate	$V_{O, cm} = 0.5\text{ V p-p}$		59		V/ $\mu\text{s}$
Gain		0.96	1.00	1.04	V/V
$V_{OCM}$ INPUT CHARACTERISTICS					
Input Voltage Range		1.0		2.0	V
Input Resistance			35		$\text{k}\Omega$
Input Offset Voltage		-25	$\pm 5.5$	+25	mV
Input Voltage Noise	$f = 100\text{ kHz to }5\text{ MHz}$		18		nV/ $\sqrt{\text{Hz}}$
Input Bias Current			0.3	0.7	$\mu\text{A}$
CMRR	$\Delta V_{O, dm} / \Delta V_{OCM}$ , $\Delta V_{OCM} = \pm 0.5\text{ V}$	62	74		dB
POWER SUPPLY					
Operating Range		+2.7		$\pm 6$	V
Quiescent Current			2.3	2.5	mA
Quiescent Current, Disabled	Power-Down = Low		345	460	$\mu\text{A}$
PSRR	$\Delta V_S = \pm 1\text{ V}$	78	90		dB
PD PIN					
Threshold Voltage		$V_{S-} + 0.7$		$V_{S-} + 1.5$	V
Input Current	Power-Down = High/Low		8/65	10/70	$\mu\text{A}$
OPERATING TEMPERATURE RANGE					
		-40		+125	$^\circ\text{C}$

# AD8137

## ABSOLUTE MAXIMUM RATINGS

Table 4.

Parameter	Rating
Supply Voltage	12 V
$V_{OCM}$	$V_{S+}$ to $V_{S-}$
Power Dissipation	See Figure 3
Input Common-Mode Voltage	$V_{S+}$ to $V_{S-}$
Storage Temperature	-65°C to +125°C
Operating Temperature Range	-40°C to +125°C
Lead Temperature Range (Soldering 10 sec)	300°C
Junction Temperature	150°C

Stresses above those listed under Absolute Maximum Ratings may cause permanent damage to the device. This is a stress rating only and functional operation of the device at these or any other conditions above those indicated in the operational section of this specification is not implied. Exposure to absolute maximum rating conditions for extended periods may affect device reliability.

### THERMAL RESISTANCE

$\theta_{JA}$  is specified for the worst-case conditions, i.e.,  $\theta_{JA}$  is specified for the device soldered in a circuit board in still air.

Table 5. Thermal Resistance

Package Type	$\theta_{JA}$	$\theta_{JC}$	Unit
SOIC-8/2-Layer	157	56	°C/W
SOIC-8/4-Layer	125	56	°C/W
LFCSP/4-Layer	70	56	°C/W

### Maximum Power Dissipation

The maximum safe power dissipation in the AD8137 package is limited by the associated rise in junction temperature ( $T_J$ ) on the die. At approximately 150°C, which is the glass transition temperature, the plastic will change its properties. Even temporarily exceeding this temperature limit may change the stresses that the package exerts on the die, permanently shifting the parametric performance of the AD8137. Exceeding a junction temperature of 175°C for an extended period of time can result in changes in the silicon devices potentially causing failure.

### ESD CAUTION

ESD (electrostatic discharge) sensitive device. Electrostatic charges as high as 4000 V readily accumulate on the human body and test equipment and can discharge without detection. Although this product features proprietary ESD protection circuitry, permanent damage may occur on devices subjected to high energy electrostatic discharges. Therefore, proper ESD precautions are recommended to avoid performance degradation or loss of functionality.

The power dissipated in the package ( $P_D$ ) is the sum of the quiescent power dissipation and the power dissipated in the package due to the load drive for all outputs. The quiescent power is the voltage between the supply pins ( $V_S$ ) times the quiescent current ( $I_S$ ). The load current consists of differential and common-mode currents flowing to the load, as well as currents flowing through the external feedback networks and the internal common-mode feedback loop. The internal resistor tap used in the common-mode feedback loop places a 1 k $\Omega$  differential load on the output. RMS output voltages should be considered when dealing with ac signals.

Airflow reduces  $\theta_{JA}$ . Also, more metal directly in contact with the package leads from metal traces, through holes, ground, and power planes will reduce the  $\theta_{JA}$ .

Figure 3 shows the maximum safe power dissipation in the package versus the ambient temperature for the SOIC-8 (125°C/W) and LFCSP ( $\theta_{JA} = 70^\circ\text{C/W}$ ) package on a JEDEC standard 4-layer board.  $\theta_{JA}$  values are approximations.

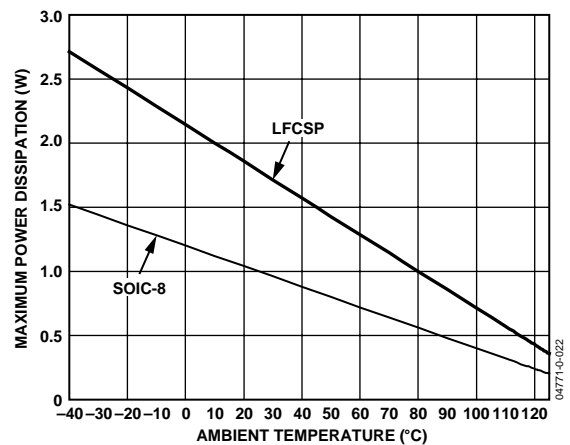

Figure 3. Maximum Power Dissipation vs. Temperature for a 4-Layer Board



## PIN CONFIGURATION AND FUNCTION DESCRIPTIONS

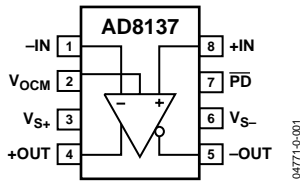

Figure 4. Pin Configuration

Table 6. Pin Function Descriptions

Pin No.	Name	Description
1	-IN	Inverting Input.
2	V <sub>OCM</sub>	An internal feedback loop drives the output common-mode voltage to be equal to the voltage applied to the V <sub>OCM</sub> pin, provided the amplifier's operation remains linear.
3	V <sub>S+</sub>	Positive Power Supply Voltage.
4	+OUT	Positive Side of the Differential Output.
5	-OUT	Negative Side of the Differential Output.
6	V <sub>S-</sub>	Negative Power Supply Voltage.
7	$\overline{\text{PD}}$	Power Down.
8	+IN	Noninverting Input.

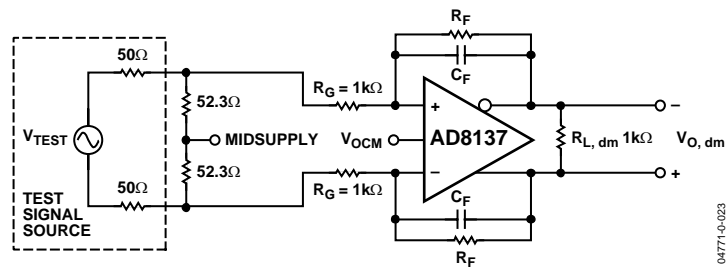

Figure 5. Basic Test Circuit

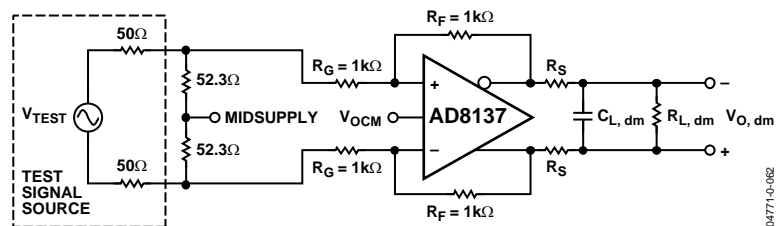

Figure 6. Capacitive Load Test Circuit,  $G = 1$

## TYPICAL PERFORMANCE CHARACTERISTICS

Unless otherwise noted, Diff. Gain = 1,  $R_G = R_F = R_{L, dm} = 1\text{ k}\Omega$ ,  $V_S = 5\text{ V}$ ,  $T_A = 25^\circ\text{C}$ ,  $V_{OCM} = 2.5\text{ V}$ . Refer to the basic test circuit in Figure 5 for the definition of terms.

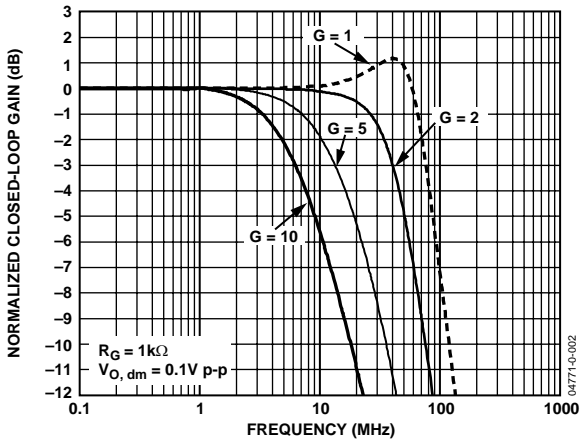

Figure 7. Small Signal Frequency Response for Various Gains

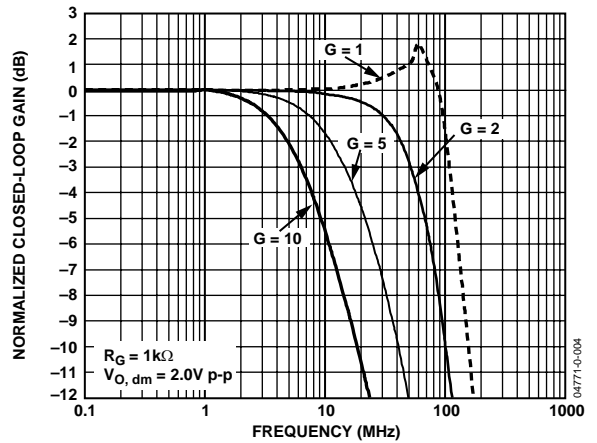

Figure 10. Large Signal Frequency Response for Various Gains

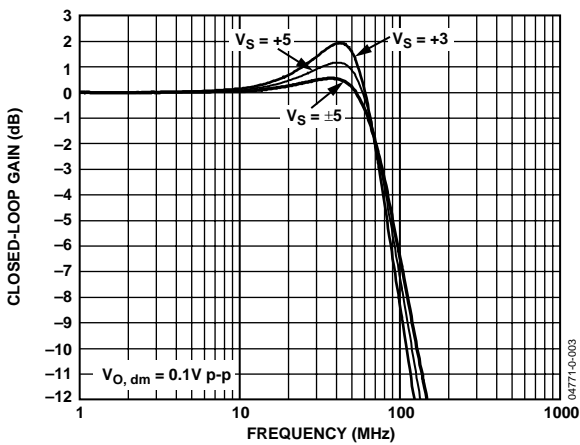

Figure 8. Small Signal Frequency Response for Various Power Supplies

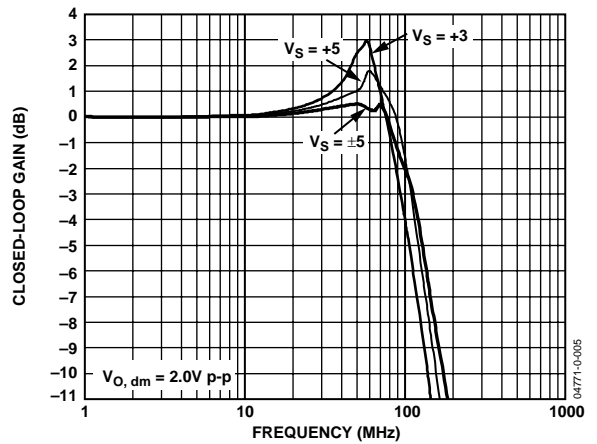

Figure 11. Large Signal Frequency Response for Various Power Supplies

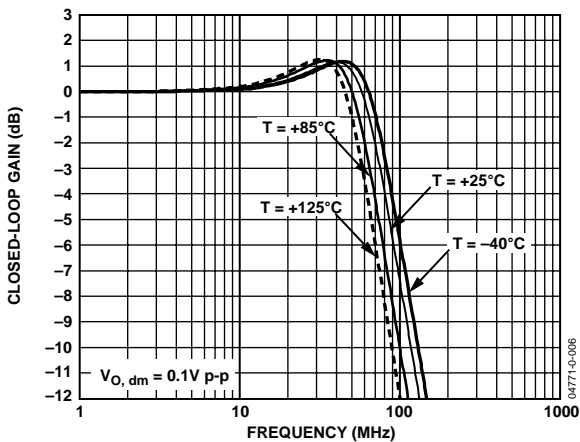

Figure 9. Small Signal Frequency Response at Various Temperatures

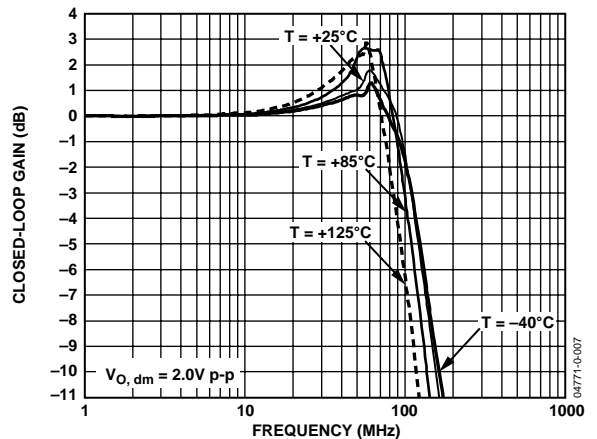

Figure 12. Large Signal Frequency Response at Various Temperatures



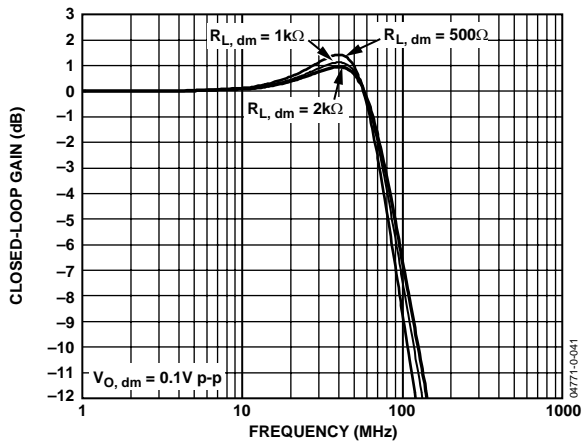

Figure 13. Small Signal Frequency Response for Various Loads

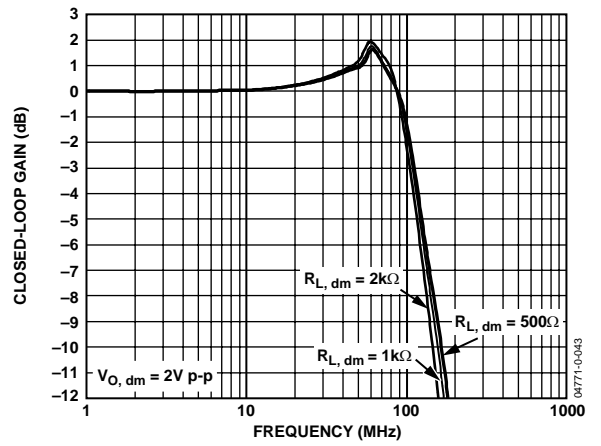

Figure 16. Large Signal Frequency Response for Various Loads

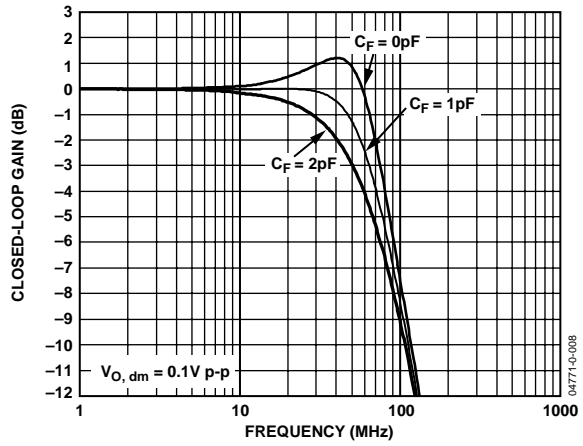

Figure 14. Small Signal Frequency Response for Various  $C_F$

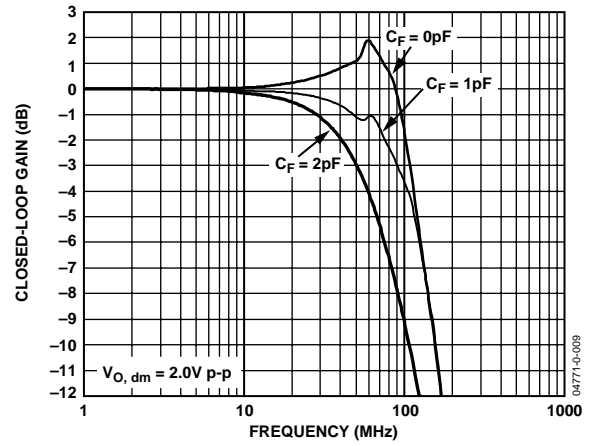

Figure 17. Large Signal Frequency Response for Various  $C_F$

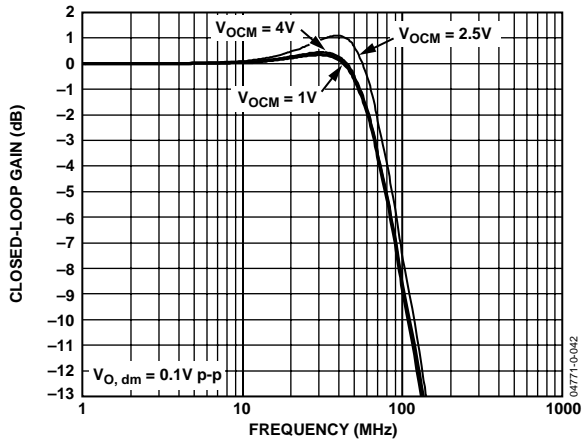

Figure 15. Small Signal Frequency Response at Various  $V_{OCM}$

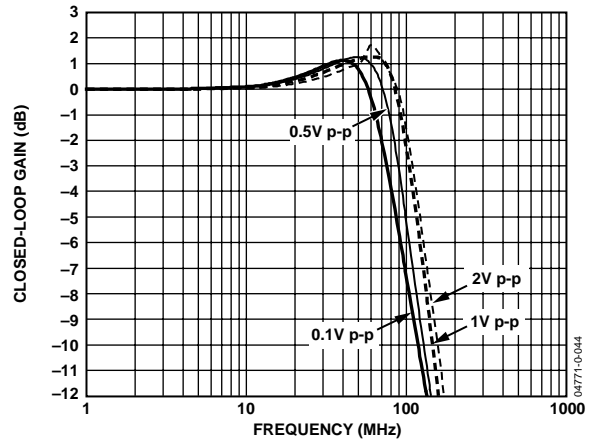

Figure 18. Frequency Response for Various Output Amplitudes

# AD8137

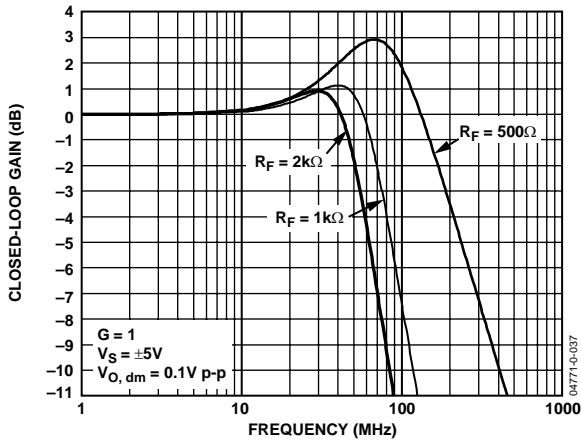

Figure 19. Small Signal Frequency Response for Various  $R_F$

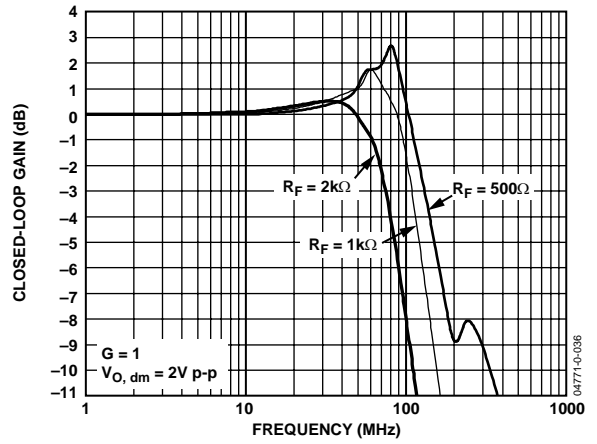

Figure 22. Large Signal Frequency Response for Various  $R_F$

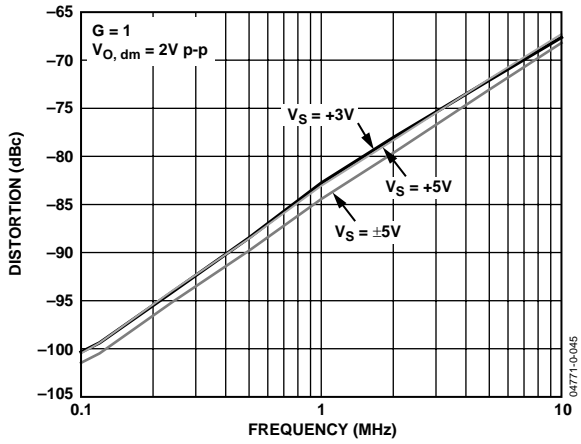

Figure 20. Second Harmonic Distortion vs. Frequency and Supply Voltage

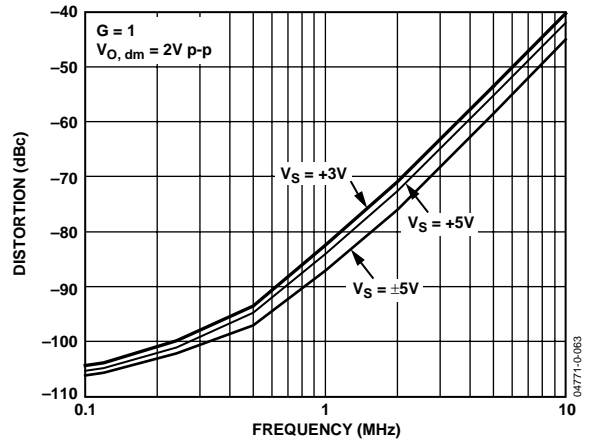

Figure 23. Third Harmonic Distortion vs. Frequency and Supply Voltage

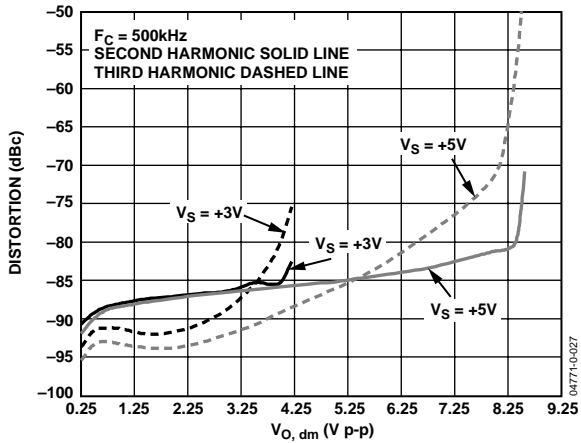

Figure 21. Harmonic Distortion vs. Output Amplitude and Supply,  $F_C = 500 \text{ kHz}$

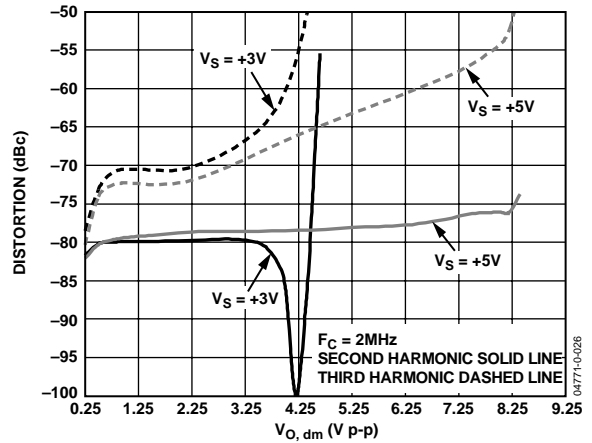

Figure 24. Harmonic Distortion vs. Output Amplitude and Supply,  $F_C = 2 \text{ MHz}$

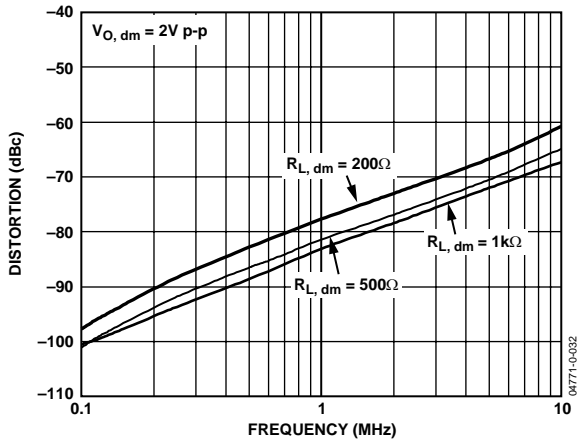

Figure 25. Second Harmonic Distortion at Various Loads

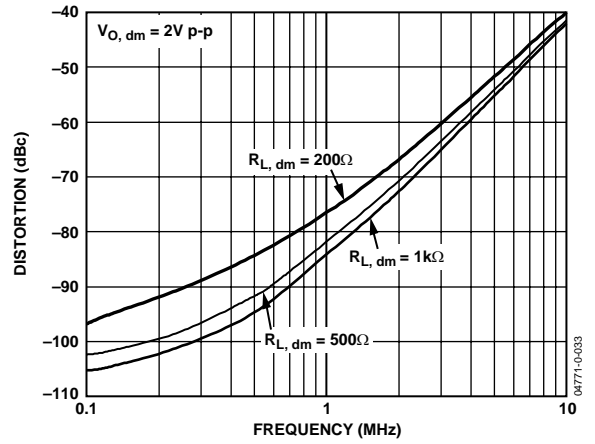

Figure 28. Third Harmonic Distortion at Various Loads

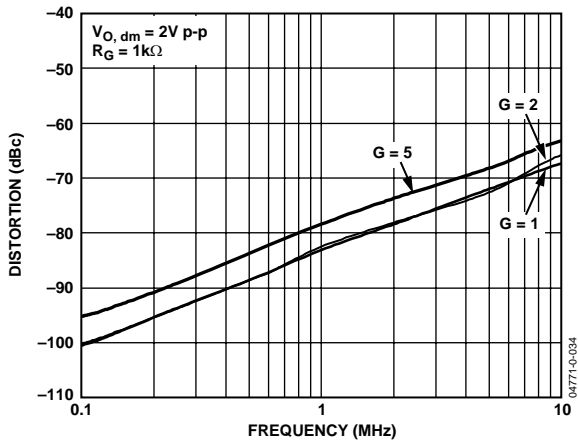

Figure 26. Second Harmonic Distortion at Various Gains

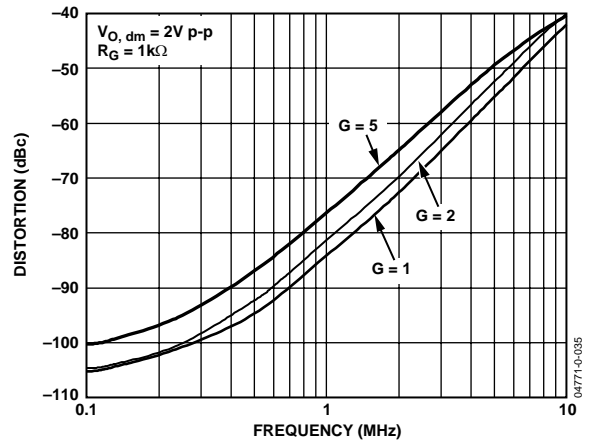

Figure 29. Third Harmonic Distortion at Various Gains

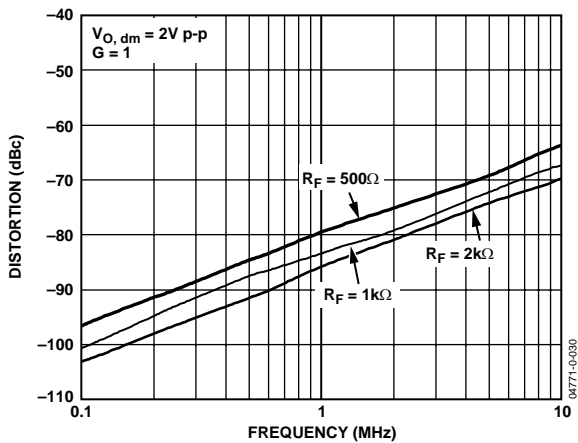

Figure 27. Second Harmonic Distortion at Various  $R_F$

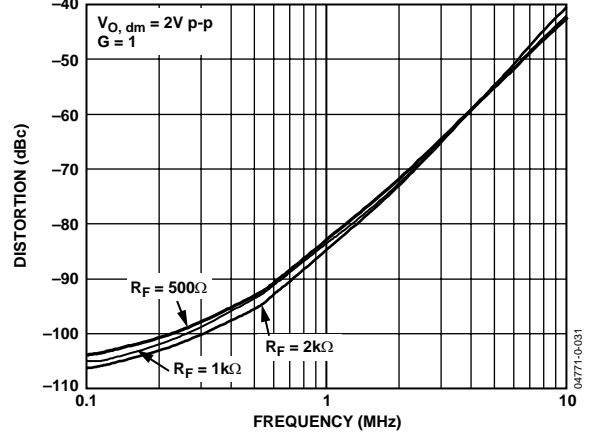

Figure 30. Third Harmonic Distortion at Various  $R_F$

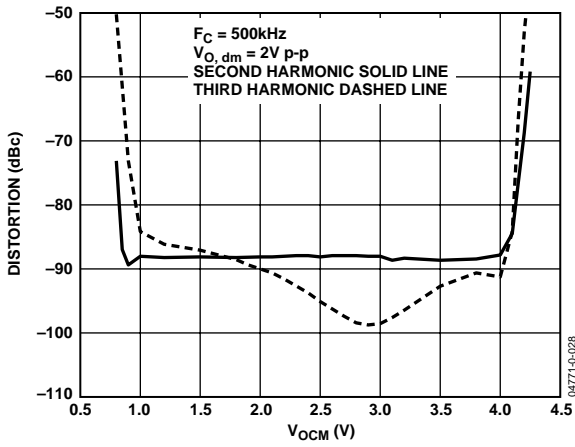

Figure 31. Harmonic Distortion vs.  $V_{OCM}$ ,  $V_S = +5\text{V}$

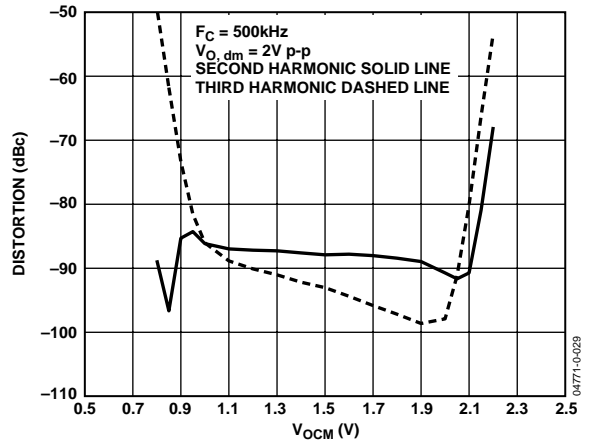

Figure 34. Harmonic Distortion vs.  $V_{OCM}$ ,  $V_S = +3\text{V}$

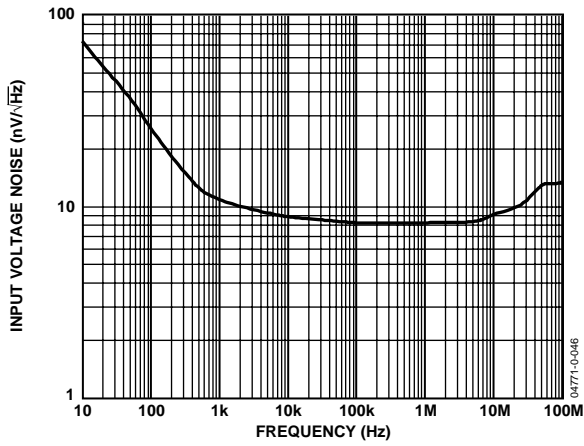

Figure 32. Input Voltage Noise vs. Frequency

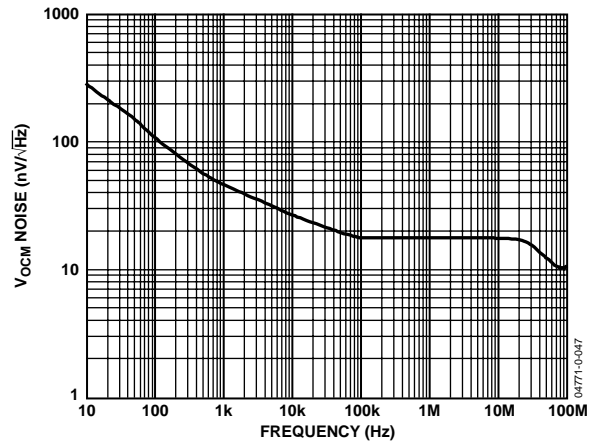

Figure 35.  $V_{OCM}$  Voltage Noise vs. Frequency

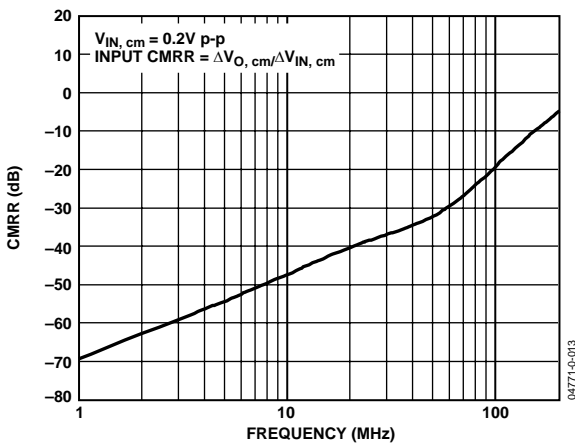

Figure 33. CMRR vs. Frequency

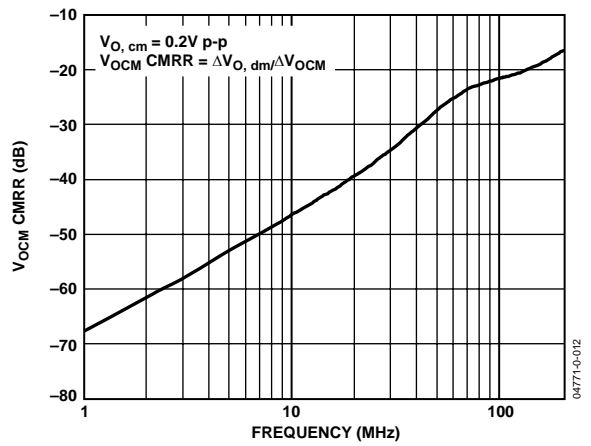

Figure 36.  $V_{OCM}$  CMRR vs. Frequency

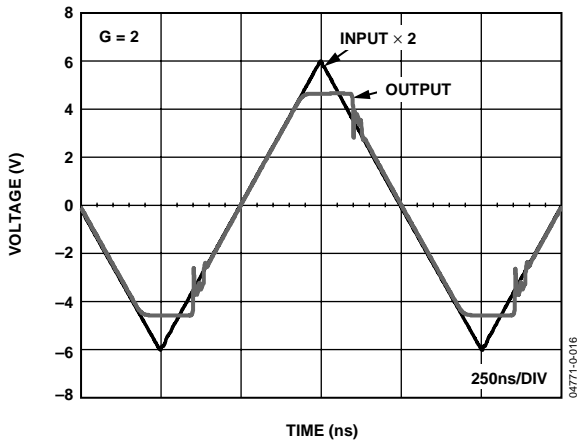

Figure 37. Overdrive Recovery

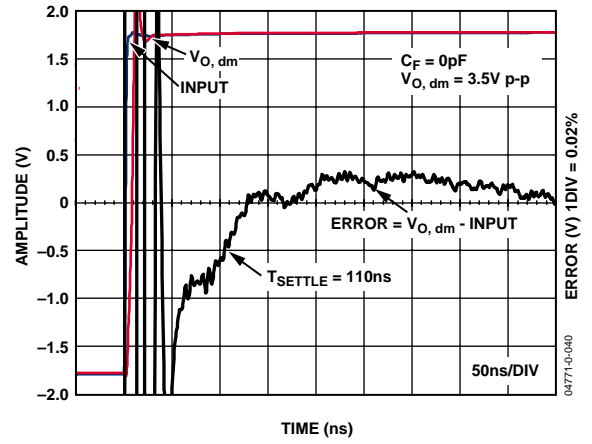

Figure 40. Settling Time (0.02%)

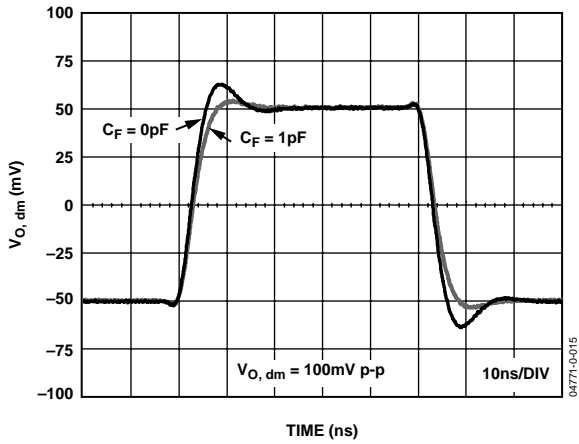

Figure 38. Small Signal Transient Response for Various Feedback Capacitances

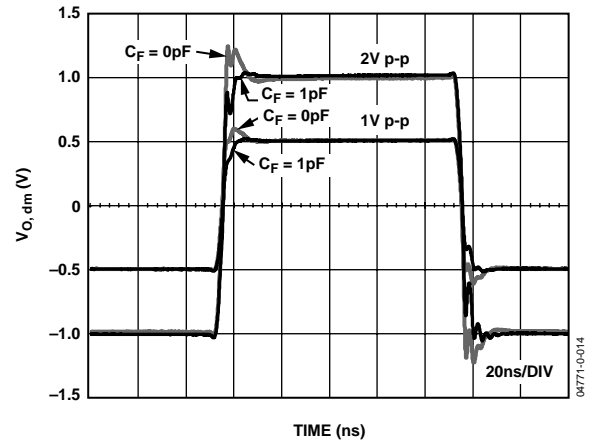

Figure 41. Large Signal Transient Response for Various Feedback Capacitances

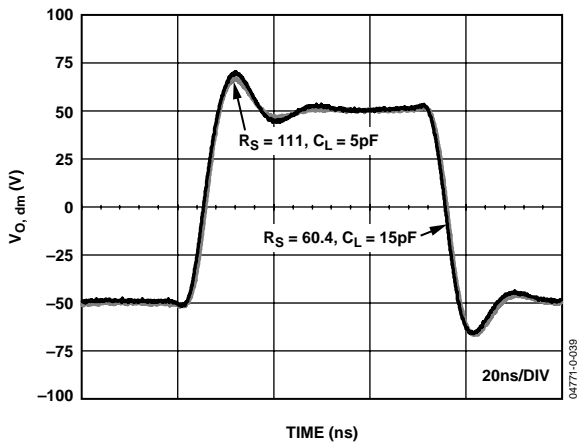

Figure 39. Small Signal Transient Response for Various Capacitive Loads

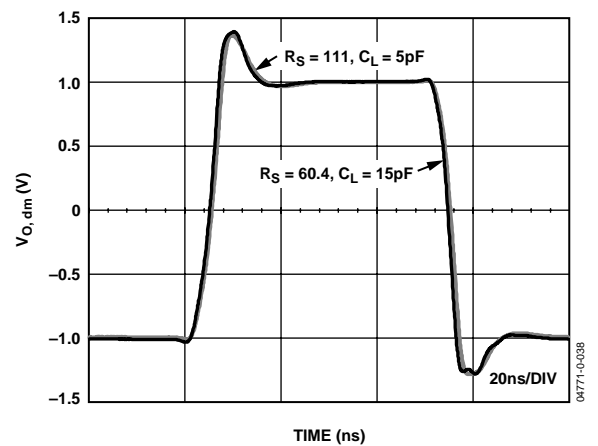

Figure 42. Large Signal Transient Response for Various Capacitive Loads

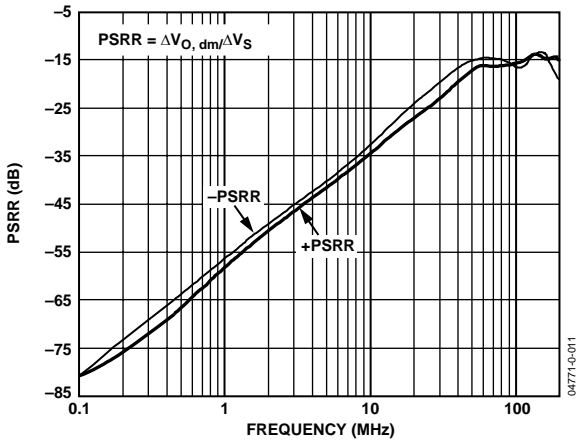

Figure 43. PSRR vs. Frequency

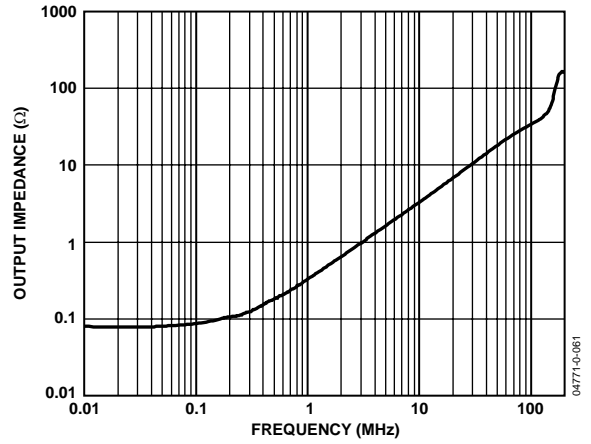

Figure 46. Single-Ended Output Impedance vs. Frequency

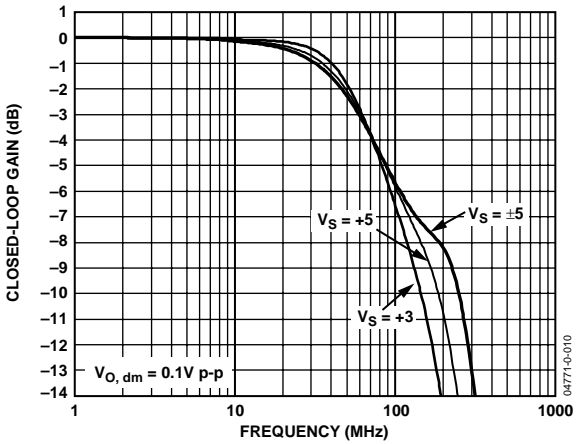

Figure 44.  $V_{OCM}$  Small Signal Frequency Response for Various Supply Voltages

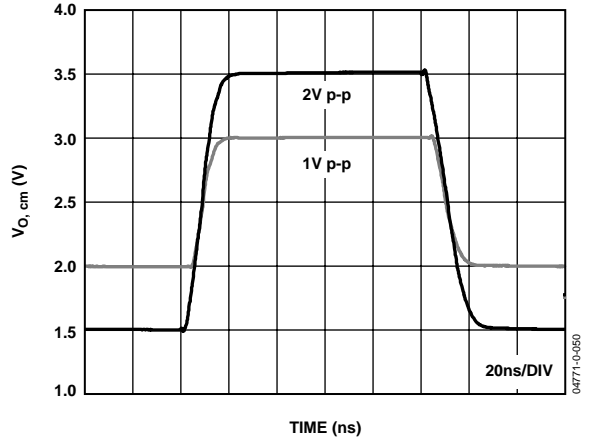

Figure 47.  $V_{OCM}$  Large Signal Transient Response

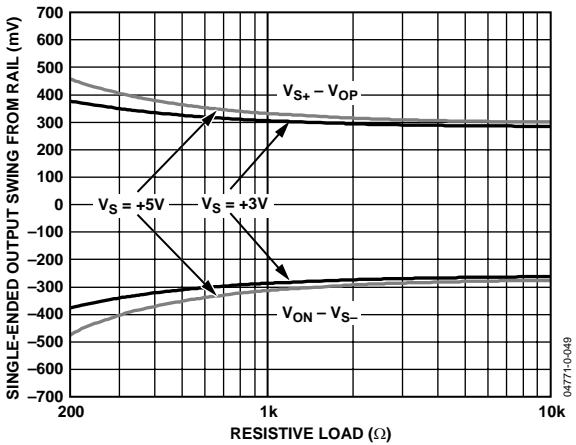

Figure 45. Output Saturation Voltage vs. Output Load

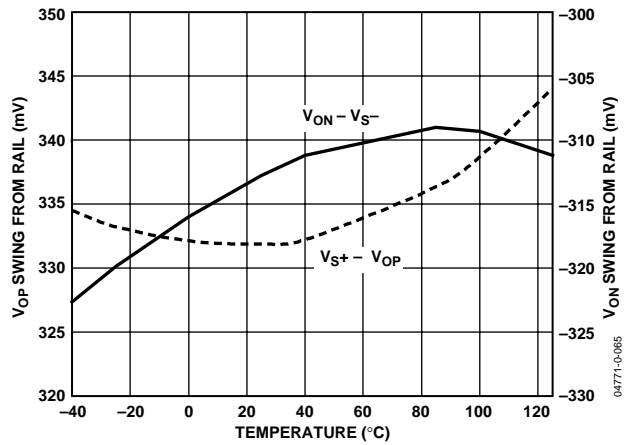

Figure 48. Output Saturation Voltage vs. Temperature

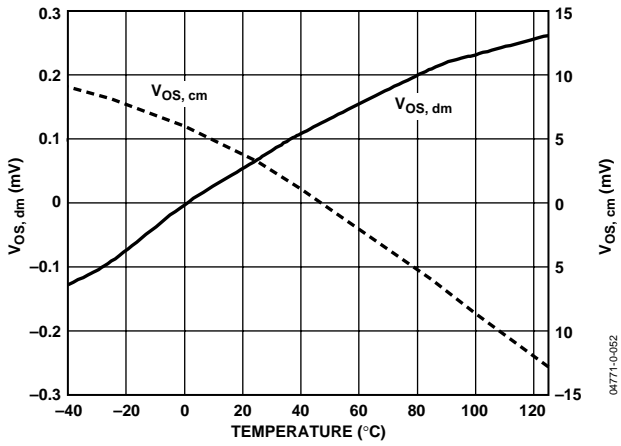

Figure 49. Offset Voltage vs. Temperature

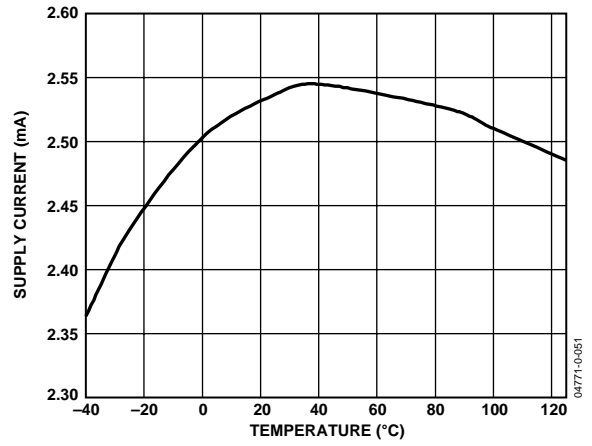

Figure 52. Supply Current vs. Temperature

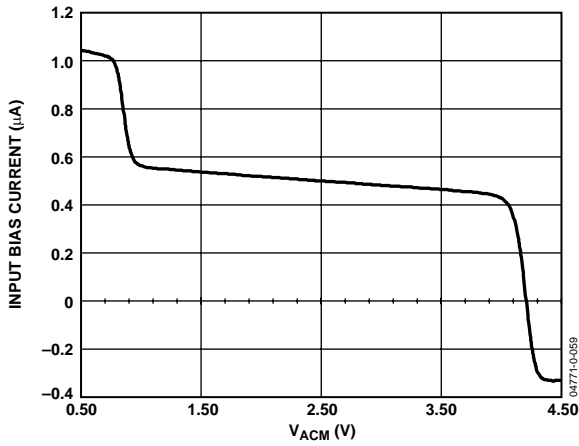

Figure 50. Input Bias Current vs. Input Common-Mode Voltage,  $V_{ACM}$

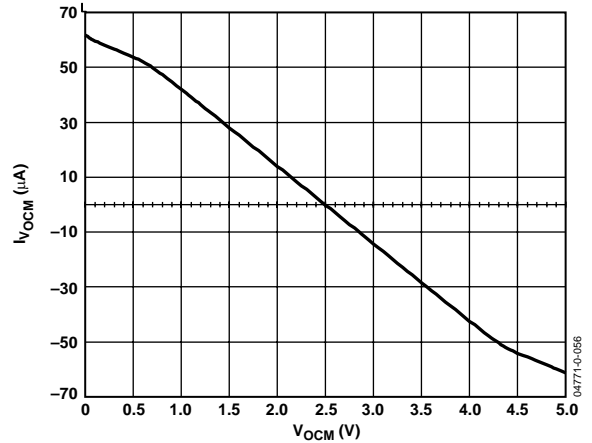

Figure 53.  $V_{OCM}$  Bias Current vs.  $V_{OCM}$  Input Voltage

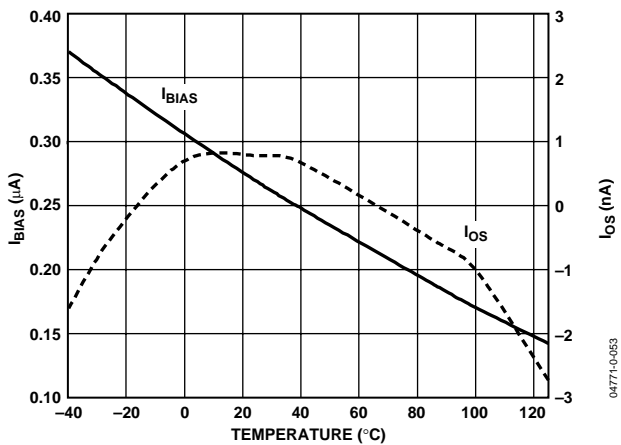

Figure 51. Input Bias and Offset Current vs. Temperature

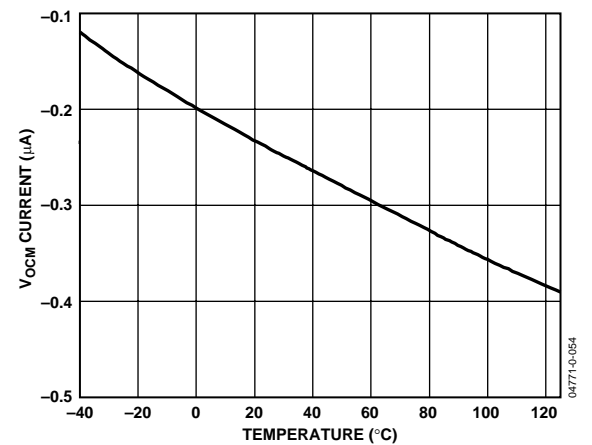

Figure 54.  $V_{OCM}$  Bias Current vs. Temperature

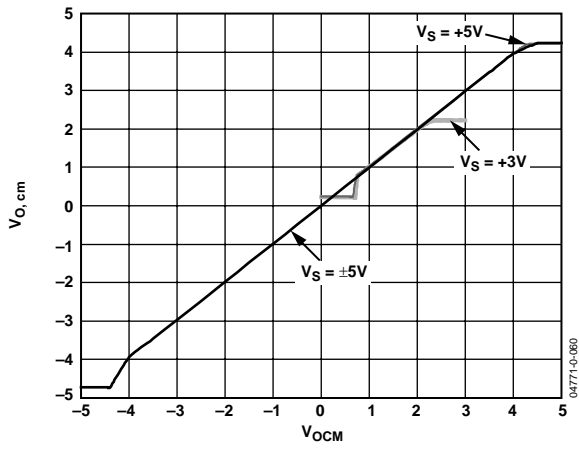

Figure 55.  $V_{O,cm}$  vs.  $V_{OCM}$  Input Voltage

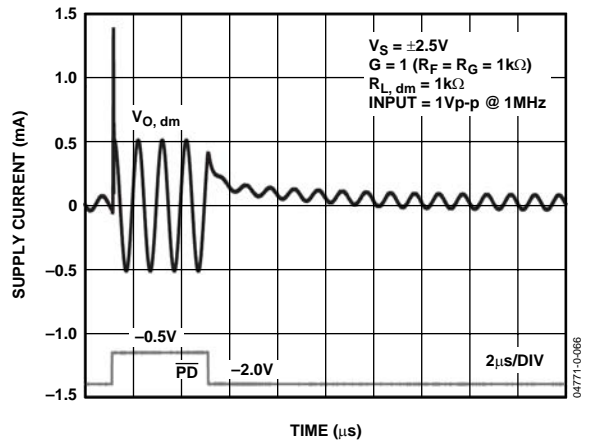

Figure 58. Power-Down Transient Response

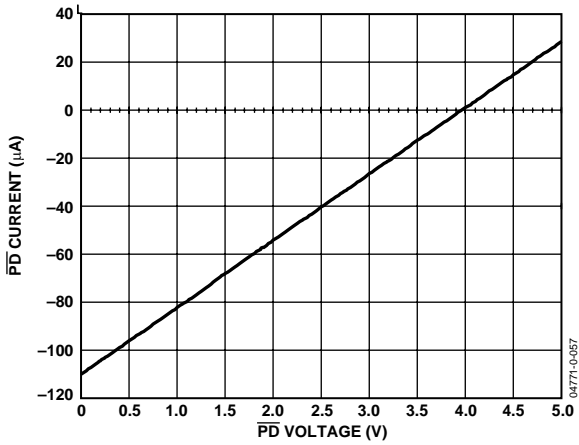

Figure 56.  $\overline{PD}$  Current vs.  $\overline{PD}$  Voltage

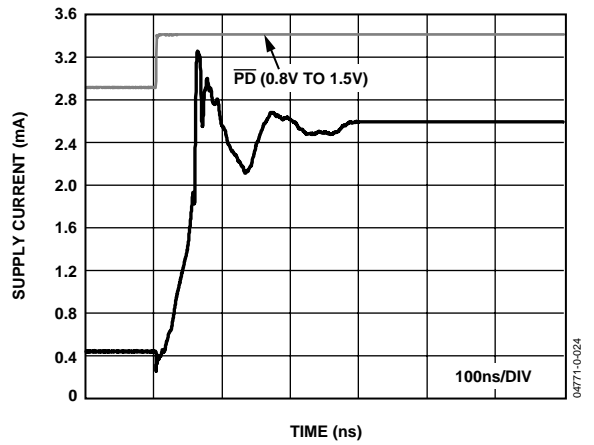

Figure 59. Power-Down Turn-On Time

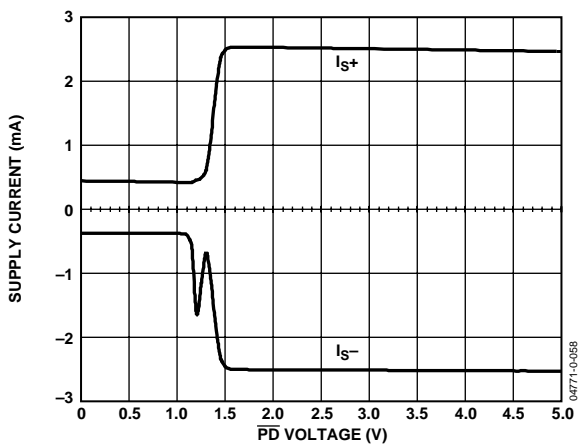

Figure 57. Supply Current vs.  $\overline{PD}$  Voltage

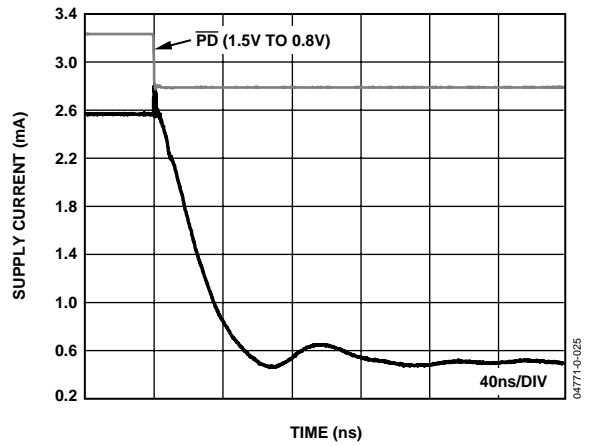

Figure 60. Power-Down Turn-Off Time



## THEORY OF OPERATION

The AD8137 is a low power, low cost, fully differential voltage feedback amplifier that features a rail-to-rail output stage, common-mode circuitry with an internally derived common-mode reference voltage, and bias shutdown circuitry. The amplifier uses two feedback loops to separately control differential and common-mode feedback. The differential gain is set with external resistors as in a traditional amplifier while the output common-mode voltage is set by an internal feedback loop, controlled by an external  $V_{OCM}$  input. This architecture makes it easy to arbitrarily set the output common-mode voltage level without affecting the differential gain of the amplifier.

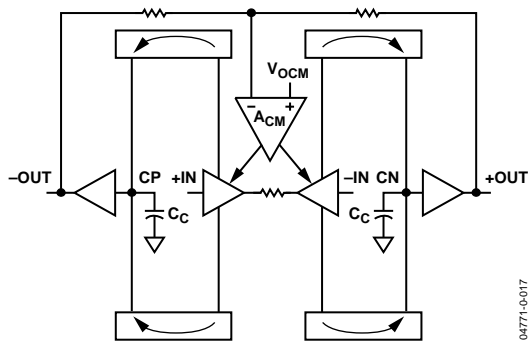

Figure 61. Block Diagram

From Figure 61, the input transconductance stage is an H-bridge whose output current is mirrored to high impedance nodes CP and CN. The output section is traditional H-bridge driven circuitry with common emitter devices driving nodes +OUT and -OUT. The 3 dB point of the amplifier is defined as

$$BW = \frac{g_m}{2\pi \times C_C}$$

where  $g_m$  is the transconductance of the input stage and  $C_C$  is the total capacitance on node CP/CN (capacitances CP and CN are well matched). For the AD8137, the input stage  $g_m$  is  $\sim 1$  mA/V and the capacitance  $C_C$  is 3.5 pF, setting the crossover frequency of the amplifier at 41 MHz. This frequency generally establishes an amplifier's unity gain bandwidth, but with the AD8137, the closed-loop bandwidth depends upon the feedback resistor value as well (see Figure 19). The open-loop gain and phase simulations are shown in Figure 62.

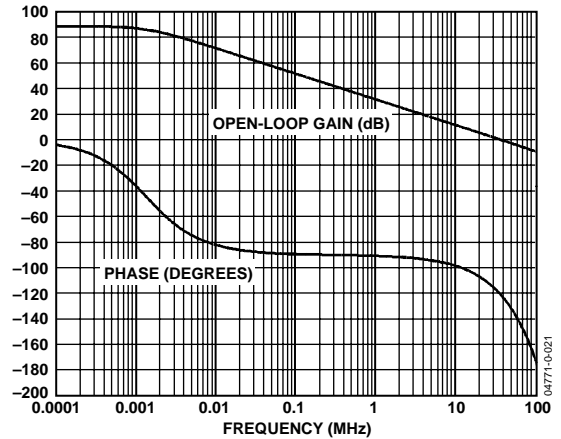

Figure 62. Open-Loop Gain and Phase

In Figure 61, the common-mode feedback amplifier  $A_{CM}$  samples the output common-mode voltage, and by negative feedback forces the output common-mode voltage to be equal to the voltage applied to the  $V_{OCM}$  input. In other words, the feedback loop serves the output common-mode voltage to the voltage applied to the  $V_{OCM}$  input. An internal bias generator sets the  $V_{OCM}$  level to approximately midsupply, therefore, the output common-mode voltage will be set to approximately midsupply when the  $V_{OCM}$  input is left floating. The source resistance of the internal bias generator is large and can be overridden easily by an external voltage supplied by a source with a relatively small output resistance. The  $V_{OCM}$  input can be driven to within approximately 1 V of the supply rails while maintaining linear operation in the common-mode feedback loop.

The common-mode feedback loop inside the AD8137 produces outputs that are highly balanced over a wide frequency range without the requirement of tightly matched external components because it forces the signal component of the output common-mode voltage to be zeroed. The result is nearly perfectly balanced differential outputs of identical amplitude and exactly  $180^\circ$  apart in phase.

# AD8137

## APPLICATIONS

### ANALYZING A TYPICAL APPLICATION WITH MATCHED $R_F$ AND $R_G$ NETWORKS

#### Typical Connection and Definition of Terms

Figure 63 shows a typical connection for the AD8137, using matched external  $R_F/R_G$  networks. The differential input terminals of the AD8137,  $V_{AP}$  and  $V_{AN}$ , are used as summing junctions. An external reference voltage applied to the  $V_{OCM}$  terminal sets the output common-mode voltage. The two output terminals,  $V_{OP}$  and  $V_{ON}$ , move in opposite directions in a balanced fashion in response to an input signal.

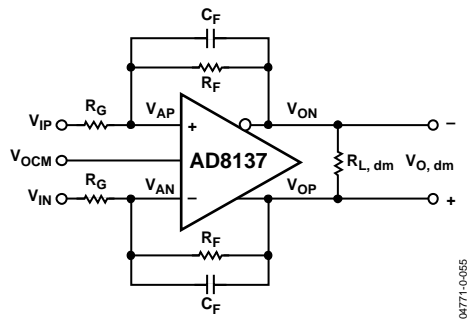

Figure 63. Typical Connection

The differential output voltage is defined as

$$V_{O, dm} = V_{OP} - V_{ON} \quad (1)$$

Common-mode voltage is the average of two voltages. The output common-mode voltage is defined as

$$V_{O, cm} = \frac{V_{OP} + V_{ON}}{2} \quad (2)$$

#### Output Balance

Output balance is a measure of how well  $V_{OP}$  and  $V_{ON}$  are matched in amplitude and how precisely they are 180 degrees out of phase with each other. It is the internal common-mode feedback loop that forces the signal component of the output common-mode towards zero, resulting in the near perfectly balanced differential outputs of identical amplitude and exactly 180 degrees out of phase. The output balance performance does not require tightly matched external components, nor does it require that the feedback factors of each loop be equal to each other. Low frequency output balance is limited ultimately by the mismatch of an on-chip voltage divider.

Output balance is measured by placing a well matched resistor divider across the differential voltage outputs and comparing the signal at the divider's midpoint with the magnitude of the differential output. By this definition, output balance is equal to the magnitude of the change in output common-mode voltage divided by the magnitude of the change in output differential-mode voltage:

$$\text{Output Balance} = \left| \frac{\Delta V_{O, cm}}{\Delta V_{O, dm}} \right| \quad (3)$$

The differential negative feedback drives the voltages at the summing junctions  $V_{AN}$  and  $V_{AP}$  to be essentially equal to each other.

$$V_{AN} = V_{AP} \quad (4)$$

The common-mode feedback loop drives the output common-mode voltage, sampled at the midpoint of the two internal common-mode tap resistors in Figure 61, to equal the voltage set at the  $V_{OCM}$  terminal. This ensures that

$$V_{OP} = V_{OCM} + \frac{V_{O, dm}}{2} \quad (5)$$

and

$$V_{ON} = V_{OCM} - \frac{V_{O, dm}}{2} \quad (6)$$

### ESTIMATING NOISE, GAIN, AND BANDWIDTH WITH MATCHED FEEDBACK NETWORKS

#### Estimating Output Noise Voltage and Bandwidth

The total output noise is the root-sum-squared total of several statistically independent sources. Since the sources are statistically independent, the contributions of each must be individually included in the root-sum-square calculation. Table 7 lists recommended resistor values and estimates of bandwidth and output differential voltage noise for various closed-loop gains. For most applications, 1% resistors are sufficient.

Table 7. Recommended Values of Gain-Setting Resistors, and Voltage Gain for Various Closed-Loop Gains

Gain	$R_G$ ( $\Omega$ )	$R_F$ ( $\Omega$ )	3 dB Bandwidth (MHz)	Total Output Noise (nV/ $\sqrt{\text{Hz}}$ )
1	1 k	1 k	72	18.6
2	1 k	2 k	40	28.9
5	1 k	5 k	12	60.1
10	1 k	10 k	6	112.0

The differential output voltage noise contains contributions from the AD8137's input voltage noise and input current noise as well as those from the external feedback networks.

The contribution from the input voltage noise spectral density is computed as

$$V_{o\_n1} = v_n \left( 1 + \frac{R_F}{R_G} \right), \text{ or equivalently, } v_n / \beta \quad (7)$$

where  $v_n$  is defined as the input-referred differential voltage noise. This equation is the same as that of traditional op amps.

The contribution from the input current noise of each input is computed as

$$V_{o\_n2} = i_n (R_F) \quad (8)$$

where  $i_n$  is defined as the input noise current of one input. Each input needs to be treated separately since the two input currents are statistically independent processes.

The contribution from each  $R_G$  is computed as

$$V_{o\_n3} = \sqrt{4kTR_G} \left( \frac{R_F}{R_G} \right) \quad (9)$$

This result can be intuitively viewed as the thermal noise of each  $R_G$  multiplied by the magnitude of the differential gain.

The contribution from each  $R_F$  is computed as

$$V_{o\_n4} = \sqrt{4kTR_F} \quad (10)$$

### Voltage Gain

The behavior of the node voltages of the single-ended-to-differential output topology can be deduced from the signal definitions and Figure 63. Referring to Figure 63, ( $C_F = 0$ ) and setting  $V_{IN} = 0$  one can write:

$$\frac{V_{IP} - V_{AP}}{R_G} = \frac{V_{AP} - V_{ON}}{R_F} \quad (11)$$

$$V_{AN} = V_{AP} = V_{OP} \left[ \frac{R_G}{R_F + R_G} \right] \quad (12)$$

Solving the above two equations and setting  $V_{IP}$  to  $V_i$  gives the gain relationship for  $V_{O, dm} / V_i$ .

$$V_{OP} - V_{ON} = V_{O, dm} = \frac{R_F}{R_G} V_i \quad (13)$$

An inverting configuration with the same gain magnitude can be implemented by simply applying the input signal to  $V_{IN}$  and setting  $V_{IP} = 0$ . For a balanced differential input, the gain from  $V_{IN, dm}$  to  $V_{O, dm}$  is also equal to  $R_F / R_G$ , where  $V_{IN, dm} = V_{IP} - V_{IN}$ .

### Feedback Factor Notation

When working with differential drivers, it is convenient to introduce the feedback factor  $\beta$ , which is defined as

$$\beta \equiv \frac{R_G}{R_F + R_G} \quad (14)$$

This notation is consistent with conventional feedback analysis and is very useful, particularly when the two feedback loops are not matched.

### Input Common-Mode Voltage

The linear range of the  $V_{AN}$  and  $V_{AP}$  terminals extends to within approximately 1 V of either supply rail. Since  $V_{AN}$  and  $V_{AP}$  are essentially equal to each other, they are both equal to the amplifier's input common-mode voltage. Their range is indicated in the specifications tables as input common-mode range. The voltage at  $V_{AN}$  and  $V_{AP}$  for the connection diagram in Figure 63 can be expressed as

$$V_{AN} = V_{AP} = V_{ACM} = \left( \frac{R_F}{R_F + R_G} \times \frac{(V_{IP} + V_{IN})}{2} \right) + \left( \frac{R_G}{R_F + R_G} \times V_{OCM} \right) \quad (15)$$

where  $V_{ACM}$  is the common-mode voltage present at the amplifier input terminals.

Using the  $\beta$  notation, Equation (15) can be written as

$$V_{ACM} = \beta V_{OCM} + (1 - \beta) V_{ICM} \quad (16)$$

or equivalently,

$$V_{ACM} = V_{ICM} + \beta (V_{OCM} - V_{ICM}) \quad (17)$$

where  $V_{ICM}$  is the common-mode voltage of the input signal, i.e.,

$$V_{ICM} \equiv \frac{V_{IP} + V_{IN}}{2}.$$

For proper operation, the voltages at  $V_{AN}$  and  $V_{AP}$  must stay within their respective linear ranges.

### Calculating Input Impedance

The input impedance of the circuit in Figure 63 will depend on whether the amplifier is being driven by a single-ended or a differential signal source. For balanced differential input signals, the differential input impedance ( $R_{IN, dm}$ ) is simply

$$R_{IN, dm} = 2R_G \quad (18)$$

For a single-ended signal (for example, when  $V_{IN}$  is grounded, and the input signal drives  $V_{IP}$ ), the input impedance becomes

$$R_{IN} = \frac{R_G}{1 - \frac{R_F}{2(R_G + R_F)}} \quad (19)$$

# AD8137

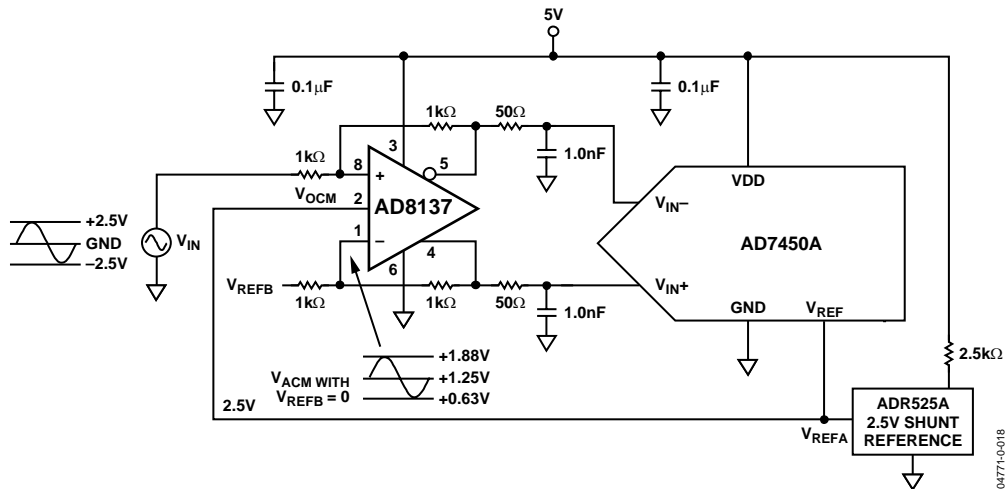

Figure 64. AD8137 Driving AD7450A, 12-Bit A/D Converter

The input impedance of a conventional inverting op amp configuration is simply  $R_G$ , but it is higher in Equation 19 because a fraction of the differential output voltage appears at the summing junctions,  $V_{AN}$  and  $V_{AP}$ . This voltage partially bootstraps the voltage across the input resistor  $R_G$ , leading to the increased input resistance.

### Input Common-Mode Swing Considerations

In some single-ended-to-differential applications when using a single-supply voltage, attention must be paid to the swing of the input common-mode voltage,  $V_{ACM}$ .

Consider the case in Figure 64, where  $V_{IN}$  is 5 V p-p swinging about a baseline at ground and  $V_{REFB}$  is connected to ground. The input signal to the AD8137 is originating from a source with a very low output resistance.

The circuit has a differential gain of 1.0 and  $\beta = 0.5$ .  $V_{ICM}$  has an amplitude of 2.5 V p-p and is swinging about ground. Using the results in Equation 16, the common-mode voltage at the AD8137's inputs,  $V_{ACM}$ , is a 1.25 V p-p signal swinging about a baseline of 1.25 V. The maximum negative excursion of  $V_{ACM}$  in this case is 0.63 V, which exceeds the lower input common-mode voltage limit.

One way to avoid the input common-mode swing limitation is to bias  $V_{IN}$  and  $V_{REF}$  at midsupply. In this case,  $V_{IN}$  is 5 V p-p swinging about a baseline at 2.5 V, and  $V_{REF}$  is connected to a low-Z 2.5 V source.  $V_{ICM}$  now has an amplitude of 2.5 V p-p and is swinging about 2.5 V. Using the results in Equation 17,  $V_{ACM}$  is calculated to be equal to  $V_{ICM}$  because  $V_{OCM} = V_{ICM}$ . Therefore,  $V_{ICM}$  swings from 1.25 V to 3.75 V, which is well within the input common-mode voltage limits of the AD8137. Another benefit seen by this example is that since  $V_{OCM} = V_{ACM} = V_{ICM}$ , no wasted common-mode current flows. Figure 65 illustrates a way to provide the low-Z bias voltage. For situations that do not require a precise reference, a simple voltage divider will suffice to develop the input voltage to the buffer.

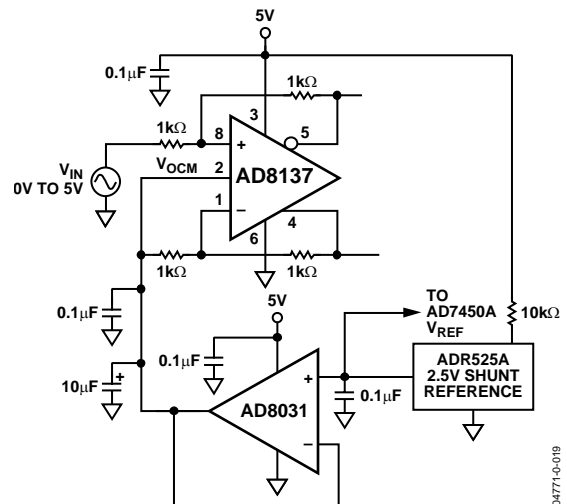

Figure 65. Low-Z Bias Source

Another way to avoid the input common-mode swing limitation is to use dual power supplies on the AD8137. In this case, the biasing circuitry is not required.

### Bandwidth Versus Closed-Loop Gain

The AD8137's 3 dB bandwidth will decrease proportionally to increasing closed-loop gain in the same way as a traditional voltage feedback operational amplifier. For closed-loop gains greater than 4, the bandwidth obtained for a specific gain can be estimated as

$$f_{-3dB, VO, dm} = \frac{R_G}{R_G + R_F} \times (72\text{MHz}) \quad (20)$$

or equivalently,  $\beta(72\text{ MHz})$ .

This estimate assumes a minimum 90 degree phase margin for the amplifier loop, a condition approached for gains greater than 4. Lower gains will show more bandwidth than predicted by the equation due to the peaking produced by the lower phase margin.

### Estimating DC Errors

Primary differential output offset errors in the AD8137 are due to three major components: the input offset voltage, the offset between the  $V_{AN}$  and  $V_{AP}$  input currents interacting with the feedback network resistances, and the offset produced by the dc voltage difference between the input and output common-mode voltages in conjunction with matching errors in the feedback network.

The first output error component is calculated as

$$V_{o\_e1} = V_{IO} \left( \frac{R_F + R_G}{R_G} \right), \text{ or equivalently as } V_{IO}/\beta \quad (21)$$

where  $V_{IO}$  is the input offset voltage.

The second error is calculated as

$$V_{o\_e2} = I_{IO} \left( \frac{R_F + R_G}{R_G} \right) \left( \frac{R_G R_F}{R_F + R_G} \right) = I_{IO} (R_F) \quad (22)$$

where  $I_{IO}$  is defined as the offset between the two input bias currents.

The third error voltage is calculated as

$$V_{o\_e3} = \Delta enr \times (V_{ICM} - V_{OCM}) \quad (23)$$

where  $\Delta enr$  is the fractional mismatch between the two feedback resistors.

The total differential offset error is the sum of these three error sources.

### Additional Impact of Mismatches in the Feedback Networks

The internal common-mode feedback network will still force the output voltages to remain balanced, even when the  $R_F/R_G$  feedback networks are mismatched. The mismatch will, however, cause a gain error proportional to the feedback network mismatch.

Ratio-matching errors in the external resistors will degrade the ability to reject common-mode signals at the  $V_{AN}$  and  $V_{IN}$  input terminals, much the same as with a four-resistor difference amplifier made from a conventional op amp. Ratio-matching errors will also produce a differential output component that is equal to the  $V_{OCM}$  input voltage times the difference between the feedback factors ( $\beta$ s). In most applications using 1% resistors, this component amounts to a differential dc offset at the output that is small enough to be ignored.

### Driving a Capacitive Load

A purely capacitive load will react with the bondwire and pin inductance of the AD8137, resulting in high frequency ringing in the transient response and loss of phase margin. One way to minimize this effect is to place a small resistor in series with each output to buffer the load capacitance. The resistor and load capacitance will form a first-order, low-pass filter, so the resistor value should be as small as possible. In some cases, the ADCs require small series resistors to be added on their inputs.

Figure 39 and Figure 42 illustrate transient response versus capacitive load, and were generated using series resistors in each output and a differential capacitive load.

### Layout Considerations

Standard high speed PCB layout practices should be adhered to when designing with the AD8137. A solid ground plane is recommended and good wideband power supply decoupling networks should be placed as close as possible to the supply pins.

To minimize stray capacitance at the summing nodes, the copper in all layers under all traces and pads that connect to the summing nodes should be removed. Small amounts of stray summing-node capacitance will cause peaking in the frequency response, and large amounts can cause instability. If some stray summing-node capacitance is unavoidable, its effects can be compensated for by placing small capacitors across the feedback resistors.

### Terminating a Single-Ended Input

Controlled impedance interconnections are used in most high speed signal applications, and they require at least one line termination. In analog applications, a matched resistive termination is generally placed at the load end of the line. This section deals with how to properly terminate a single-ended input to the AD8137.

The input resistance presented by the AD8137 input circuitry is seen in parallel with the termination resistor, and its loading effect must be taken into account. The Thevenin equivalent circuit of the driver, its source resistance, and the termination resistance must all be included in the calculation as well. An exact solution to the problem requires solution of several simultaneous algebraic equations and is beyond the scope of this data sheet. An iterative solution is also possible and is simpler, especially considering the fact that standard resistor values are generally used.

Figure 66 shows the AD8137 in a unity-gain configuration, and with the following discussion, provides a good example of how to provide a proper termination in a 50  $\Omega$  environment.

# AD8137

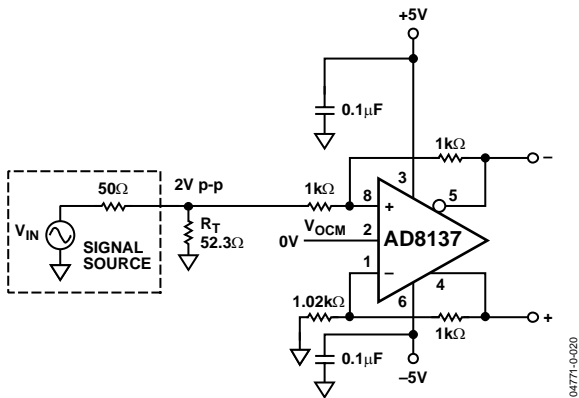

Figure 66. AD8137 with Terminated Input

The 52.3 Ω termination resistor,  $R_T$ , in parallel with the 1 kΩ input resistance of the AD8137 circuit, yields an overall input resistance of 50 Ω that is seen by the signal source. In order to have matched feedback loops, each loop must have the same  $R_G$  if they have the same  $R_F$ . In the input (upper) loop,  $R_G$  is equal to the 1 kΩ resistor in series with the (+) input plus the parallel combination of  $R_T$  and the source resistance of 50 Ω. In the upper loop,  $R_G$  is therefore equal to 1.03 kΩ. The closest standard value is 1.02 kΩ and is used for  $R_G$  in the lower loop.

Things get more complicated when it comes to determining the feedback resistor values. The amplitude of the signal source generator  $V_{IN}$  is two times the amplitude of its output signal when terminated in 50 Ω. Therefore, a 2 V p-p terminated amplitude is produced by a 4 V p-p amplitude from  $V_S$ . The Thevenin equivalent circuit of the signal source and  $R_T$  must be used when calculating the closed-loop gain because  $R_G$  in the upper loop is split between the 1 kΩ resistor and the Thevenin resistance looking back toward the source. The Thevenin voltage of the signal source is greater than the signal source output voltage when terminated in 50 Ω because  $R_T$  must always be greater than 50 Ω. In this case,  $R_T$  is 52.3 Ω and the Thevenin voltage and resistance are 2.04 V p-p and 25.6 Ω, respectively. Now the upper input branch can be viewed as a 2.04 V p-p source in series with 1.03 kΩ. Since this is to be a unity-gain application, a 2 V p-p differential output is required, and  $R_F$  must therefore be  $1.03 \text{ k}\Omega \times (2/2.04) = 1.01 \text{ k}\Omega \approx 1 \text{ k}\Omega$ . This example shows that when  $R_F$  and  $R_G$  are large compared to  $R_T$ ,

the gain reduction produced by the increase in  $R_G$  is essentially cancelled by the increase in the Thevenin voltage caused by  $R_T$  being greater than the output resistance of the signal source. In general, as  $R_F$  and  $R_G$  become smaller in terminated applications,  $R_F$  needs to be increased to compensate for the increase in  $R_G$ .

When generating the typical performance characteristics data, the measurements were calibrated to take the effects of the terminations on closed-loop gain into account.

## Power Down

The AD8137 features a  $\overline{\text{PD}}$  pin that can be used to minimize the quiescent current consumed when the device is not being used.  $\overline{\text{PD}}$  is asserted by applying a low logic level to Pin 7. The threshold between high and low logic levels is nominally 1.1 V above the negative supply rail. See the Specification tables for the threshold limits.

## DRIVING AN ADC WITH GREATER THAN 12-BIT PERFORMANCE

Since the AD8137 is suitable for 12-bit systems, it is desirable to measure the performance of the amplifier in a system with greater than 12-bit linearity. In particular, the effective number of bits, ENOB, is most interesting. The AD7687, 16-bit, 250 KSPS ADC's performance makes it an ideal candidate for showcasing the 12-bit performance of the AD8137.

For this application, the AD8137 is set in a gain of 2 and driven single-ended through a 20 kHz band-pass filter, while the output is taken differentially to the input of the AD7687 (see Figure 67). This circuit has mismatched  $R_G$  impedances and, therefore, has a dc offset at the differential output. It is included as a test circuit to illustrate the performance of the AD8137. Actual application circuits should have matched feedback networks.

For an AD7687 input range up to  $-1.82 \text{ dBFS}$ , the AD8137 power supply is a single 5 V applied to  $V_{S+}$  with  $V_{S-}$  tied to ground. To increase the AD7687 input range to  $-0.45 \text{ dBFS}$ , the AD8137 supplies are increased to +6 V and  $-1 \text{ V}$ . In both cases, the  $V_{\text{OCM}}$  pin is biased with 2.5 V and the  $\overline{\text{PD}}$  pin is left floating. All voltage supplies are decoupled with 0.1 μF capacitors. Figure 68 and Figure 69 show the performance of the  $-1.82 \text{ dBFS}$  setup and the  $-0.45 \text{ dBFS}$  setup, respectively.

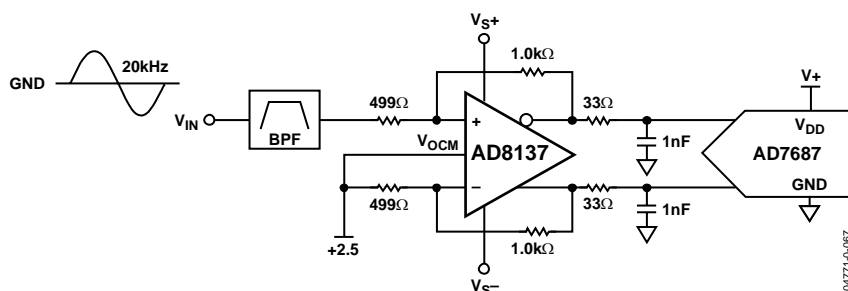

Figure 67. AD8137 Driving AD7687, 16-Bit 250 KSPS ADC

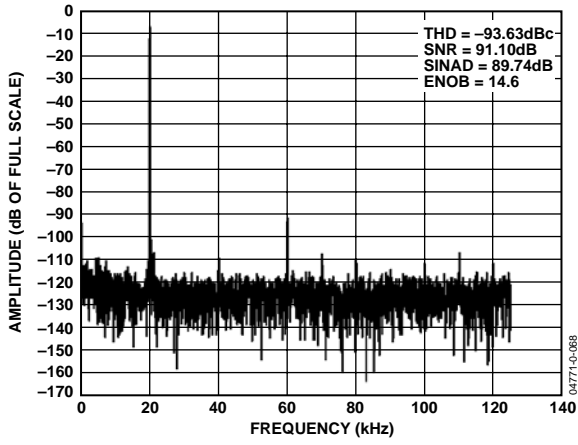

Figure 68. AD8137 Performance on Single 5 V Supply, -1.82 dBFS

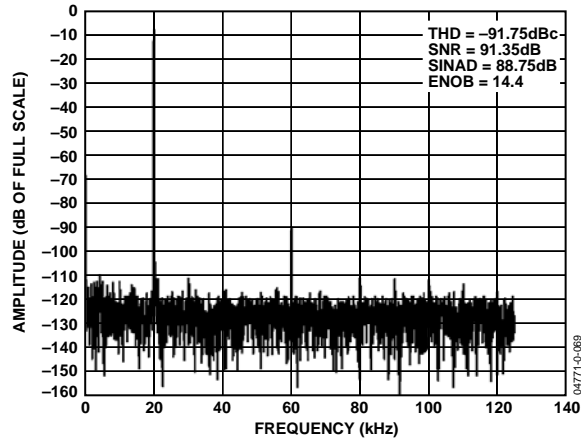
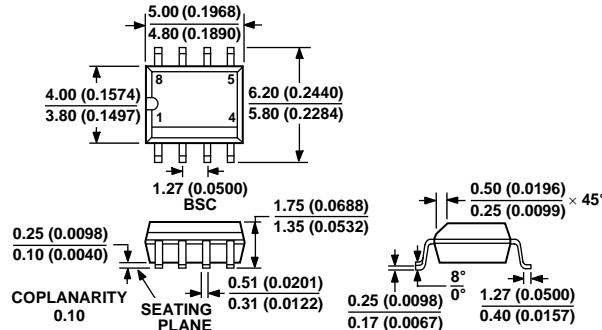

Figure 69. AD8137 Performance on +6 V, -1 V Supplies, -0.45 dBFS

# AD8137

## OUTLINE DIMENSIONS



COMPLIANT TO JEDEC STANDARDS MS-012AA  
 CONTROLLING DIMENSIONS ARE IN MILLIMETERS; INCH DIMENSIONS  
 (IN PARENTHESES) ARE ROUNDED-OFF MILLIMETER EQUIVALENTS FOR  
 REFERENCE ONLY AND ARE NOT APPROPRIATE FOR USE IN DESIGN

Figure 70. 8-Lead Standard Small Outline Package [SOIC]  
 Narrow Body (R-8)—Dimensions shown in millimeters (inches)

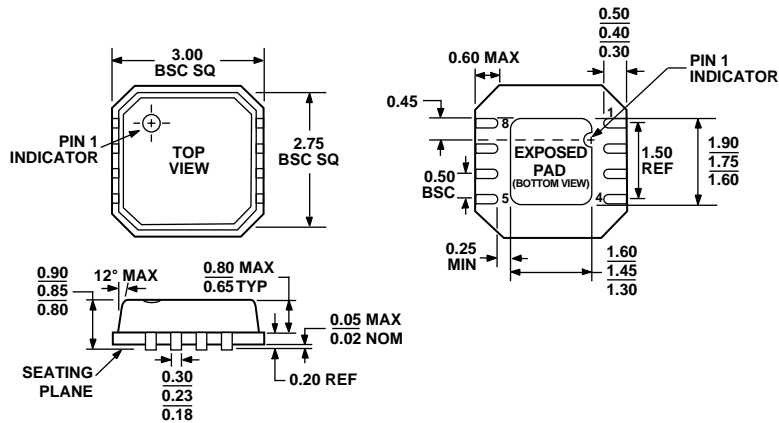

Figure 71. 8-Lead Lead Frame Chip Scale Package [LFCS]  
 3 mm x 3 mm Body (CP-8-2)—Dimensions shown in millimeters

## ORDERING GUIDE

Model	Temperature Range	Package Description	Package Option	Branding
AD8137YR	-40°C to +125°C	8-Lead Standard Small Outline Package (SOIC)	R-8	
AD8137YR-REEL	-40°C to +125°C	8-Lead Standard Small Outline Package (SOIC)	R-8	
AD8137YR-REEL7	-40°C to +125°C	8-Lead Standard Small Outline Package (SOIC)	R-8	
AD8137YRZ <sup>1</sup>	-40°C to +125°C	8-Lead Standard Small Outline Package (SOIC)	R-8	
AD8137YRZ-REEL <sup>1</sup>	-40°C to +125°C	8-Lead Standard Small Outline Package (SOIC)	R-8	
AD8137YRZ-REEL7 <sup>1</sup>	-40°C to +125°C	8-Lead Standard Small Outline Package (SOIC)	R-8	
AD8137YCP-R2	-40°C to +125°C	8-Lead Lead Frame Chip Scale Package (LFCS)	CP-8-2	HFB
AD8137YCP-REEL	-40°C to +125°C	8-Lead Lead Frame Chip Scale Package (LFCS)	CP-8-2	HFB
AD8137YCP-REEL7	-40°C to +125°C	8-Lead Lead Frame Chip Scale Package (LFCS)	CP-8-2	HFB
AD8137YCPZ-R2 <sup>1</sup>	-40°C to +125°C	8-Lead Lead Frame Chip Scale Package (LFCS)	CP-8-2	HGB
AD8137YCPZ-REEL <sup>1</sup>	-40°C to +125°C	8-Lead Lead Frame Chip Scale Package (LFCS)	CP-8-2	HGB
AD8137YCPZ-REEL7 <sup>1</sup>	-40°C to +125°C	8-Lead Lead Frame Chip Scale Package (LFCS)	CP-8-2	HGB

<sup>1</sup> Z = Pb-free part.