

FEATURES

- 4-channel WDRC compression
- 16-band frequency shaping
- 16-band adaptive noise reduction
- adaptive feedback cancellation
- FRONTWAVE® directional processing
- high fidelity CODEC – dual A/D's;D/A
- 16-bit DSP core processor
- 95dB input dynamic range with HRX™ Headroom Extension
- drives zero-bias 2-terminal receivers
- thinSTAX™ packaging
- 4 fully configurable memories with audible memory change indicator
- 2 memory select pads
- internal/external volume control
- AGCo with variable threshold and time constants

thinSTAX™ PACKAGING

Hybrid typical dimensions:

0.217 x 0.129 x 0.087in.
(5.51 x 3.28 x 2.21mm)

DESCRIPTION

DUET™ DIGITAL is a high end DSP system with advanced adaptive algorithms. The signal processing algorithms run on a hardware platform which is a combination of a high-fidelity CODEC and a general purpose DSP core. Algorithms developed and optimized by Gennum, running on this powerful platform, offer true speech processing. The reflowable thinSTAX™ packaging enables easy integration into a wide range of applications, from CIC to BTE.

As shown in the block diagram below, some of the audio DSP functions are implemented in hardware as a part of our high fidelity CODEC while other adaptive algorithms such as Noise Reduction and Feedback Cancellation use the DSP core. Pre-processing blocks include FRONTWAVE® directional processing and programmable filters. Post-processing blocks include tone generation, volume control, AGCo and programmable filters.

The GB3212 hybrid code programmed into the EEPROM is "40".

This data sheet is part of a set of documents available for this product. Please refer to [Getting Started with DUET™ DIGITAL](#), Document #29231 for a list of other documents.

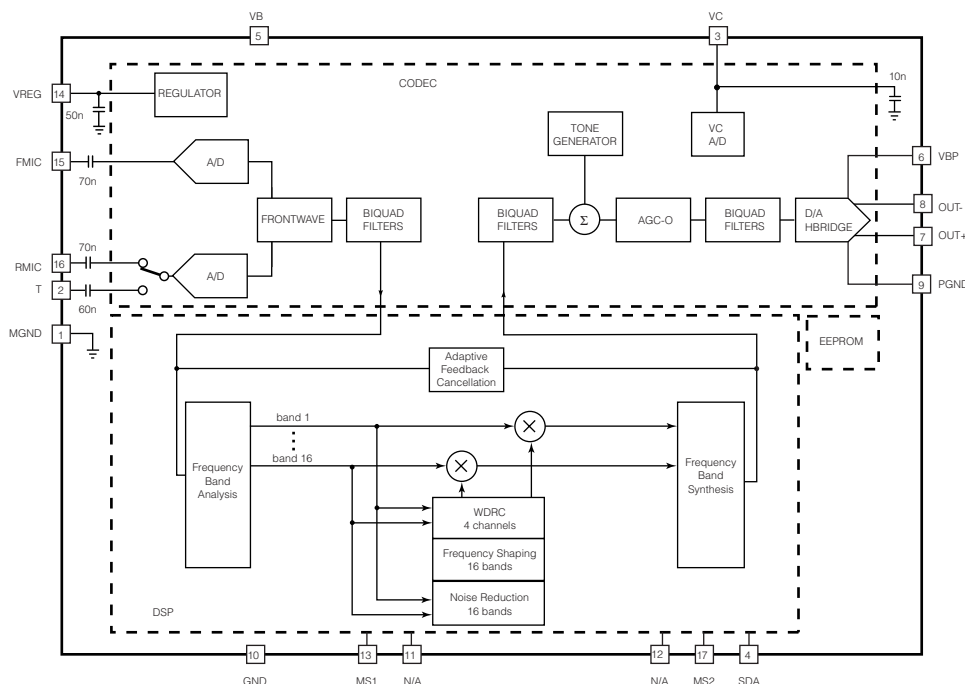

BLOCK DIAGRAM

ABSOLUTE MAXIMUM RATINGS

PARAMETER	VALUE/UNITS
Operating Temperature Range	-10°C to 40°C
Storage Temperature Range	-20°C to 70°C
Absolute Maximum Power Dissipation	25mW
Maximum Operating Supply Voltage	1.5VDC
Absolute Maximum Supply Voltage	2VDC

PAD CONNECTION

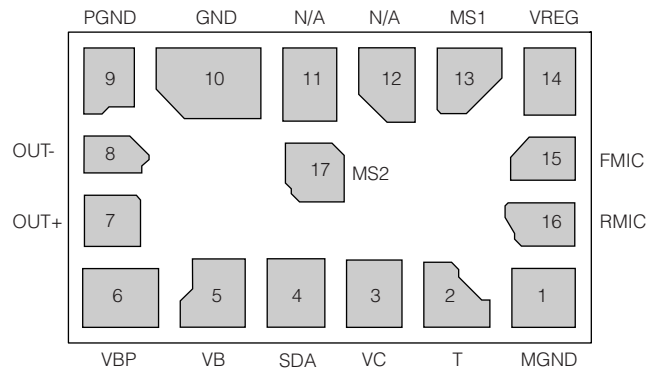

CAUTION
ELECTROSTATIC
SENSITIVE DEVICES
DO NOT OPEN PACKAGES OR HANDLE
EXCEPT AT A STATIC-FREE WORKSTATION



CAUTION
LEVEL 3 MOISTURE
SENSITIVE DEVICES
DO NOT OPEN PACKAGES EXCEPT UNDER
CONTROLLED CONDITIONS



ELECTRICAL CHARACTERISTICS

Conditions: Supply Voltage $V_B = 1.3V$; Temperature = 25°C

PARAMETER	SYMBOL	CONDITIONS	MIN	TYP	MAX	UNITS
Hybrid Current	I_{AMP}	All adaptive features enabled.	-	1.1	-	mA
Minimum Operating Supply Voltage	V_{BOFF}	Ramp down	0.94	0.97	1.0	V
Supply Voltage Turn On Threshold	V_{BON}	Ramp up	-	1.10	-	V
Low Frequency System Bandwidth			-	125	-	Hz
High Frequency System Bandwidth			-	8	-	kHz
Converter Gain	A_{CONV}	A/D + D/A gain.	-	29	-	dB
Total Harmonic Distortion	THD	$V_{IN} = -40$ dBV	-	-	1	%
THD at Maximum Input	THD _M	$V_{IN} = -15$ dBV, HRX - ON	-	-	3	%
Clock Frequency	f_{clk}		1.945	2.048	2.15	MHz
INPUT						
Input Referred Noise	IRN	Bandwidth 100Hz - 8kHz	-	-	-106	dBV
Input Impedance	Z_{IN}		-	16	-	k Ω
Anti-alias Filter Rejection (input referred)		$f = f_{clk} - 8kHz$, $V_{IN} = -40dBV$	-	80	-	dB
Maximum Input Level			-	-15	-	dBV
Input Dynamic Range		HRX - ON, Bandwidth 100Hz - 8kHz	-	95	-	dB
A/D Dynamic Range		Bandwidth 100Hz - 8kHz	-	86	-	dB
OUTPUT						
Maximum RMS Output Voltage		0dBFS $f = 1kHz$	-	-1	-	dBV
D/A Dynamic Range		Bandwidth 100Hz - 8kHz	-	83	-	dB

ELECTRICAL CHARACTERISTICS (CONTINUED)Conditions: Supply Voltage $V_B = 1.3V$; Temperature = 25°C

PARAMETER	RANGE		UNITS
	MIN	MAX	
FRONTWAVE®			
Time Delay	0.1	50	ms
Low Frequency Equalizer Corner Frequency	0.05	8	kHz
FREQUENCY SHAPING			
Pre1 and Pre2 Biquad Filter	Design Specific		N/A
PostA and PostB Biquad Filter	Design Specific		N/A
Graphic EQ Band Gain	-42	0	dB
WIDE DYNAMIC RANGE COMPRESSION			
Lower Threshold	-100	-30	dBFS
Upper Threshold	-90	-20	dBFS
Low Level Gain	-18	42	dB
High Level Gain	-18	42	dB
Compression Ratio	1:1	100:1	Ratio
Fast Detector Time Constant	4	8188	ms
Slow Detector Time Constant	4	8188	ms
AGCo			
AGCo Output Limiting	-40	0	dBFS*
AGCo Compression Ratio	$\infty : 1$		Ratio
AGCo Attack Time Constant	0.25	8192	ms
AGCo Release Time Constant	0.25	8192	ms
WIDEBAND SYSTEM GAIN			
Wideband System Gain	-36	12	dB
External Volume Control	-48	0	dB
Internal Volume Control Attenuator	-48	0	dB

* peak output is defined as largest sine wave possible at the resonant frequency of the receiver

SUPPORT SOFTWARE

All support software for the GB3212 is available from the Gennum Web site,

<http://www.gennum.com/hip/software/index.html>.

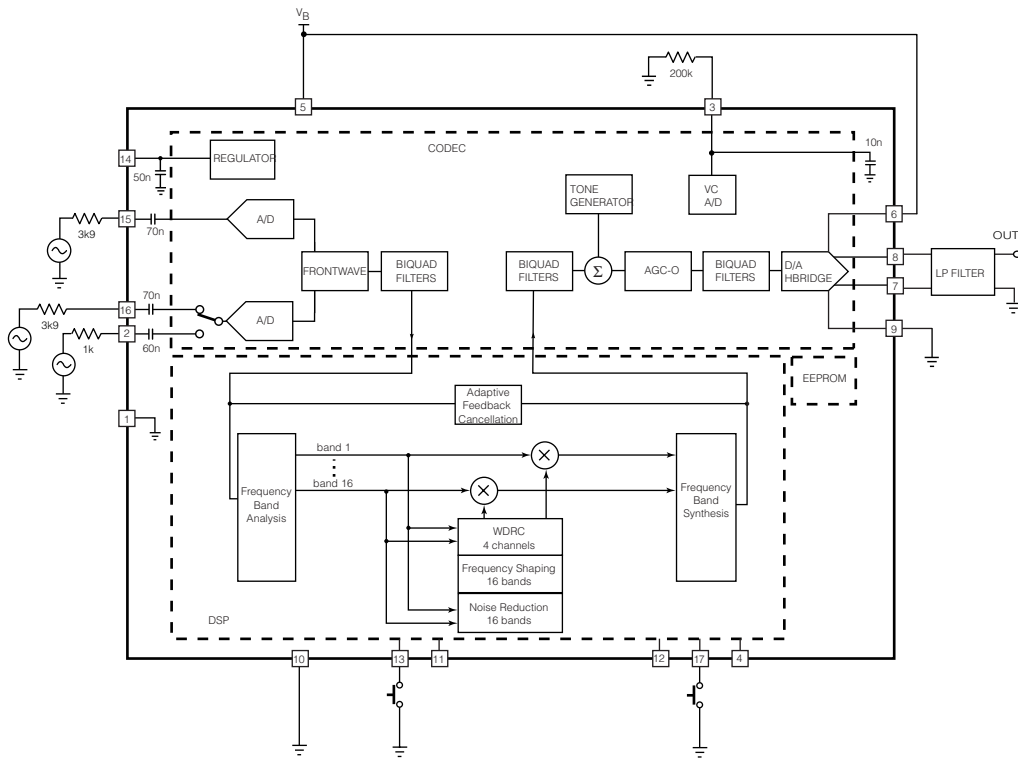

All resistors in ohms, all capacitors in farads unless otherwise stated.

Figure 1: Test circuit

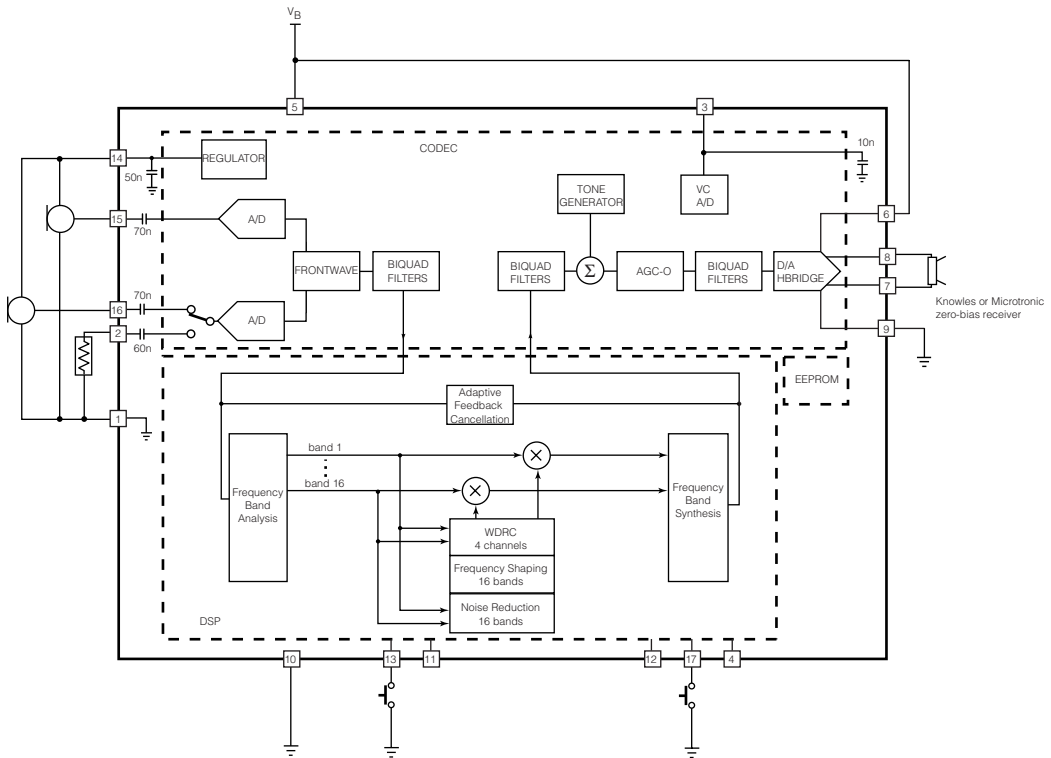

All resistors in ohms, all capacitors in farads unless otherwise stated.

Figure 2: Typical application circuit

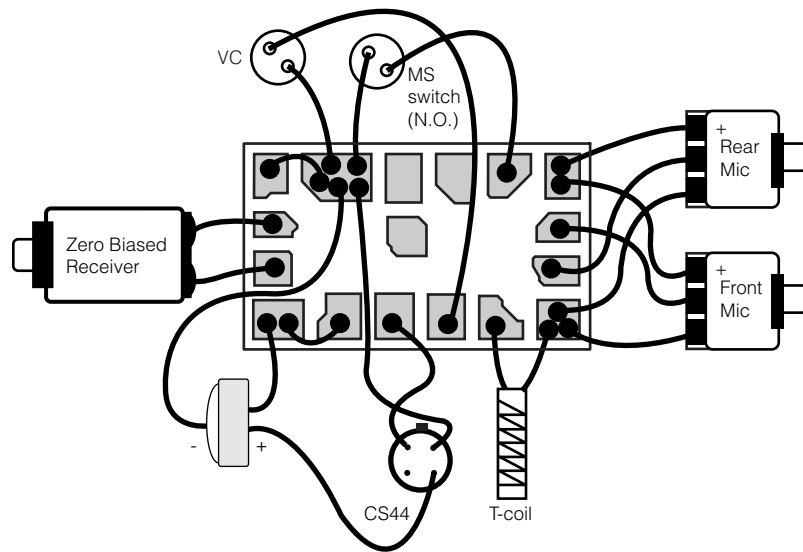

Figure 3: Assembly diagram

INTRODUCTION

The GB3212 hybrid comprises a highly versatile, advanced digital signal processing system.

Configuration data stored in non-volatile memory defines hearing aid parameters. This data needs to be uploaded to the hybrid before the circuit becomes functional. The GB3212 hybrid is programmed via the SDA pin using industry-standard programming boxes.

Configuration data is generated by an ARK product component library (DLL). Like Gennum's other digital products, the GB3212 is fully supported by Gennum's software tools available from the Gennum ARK web site <http://ark.gennum.com>.

SIGNAL PATH

There are two main audio input signal paths. The first path contains the Front Microphone and second path contains the Rear Microphone or Telecoil input as selected by a programmable MUX. The front microphone input is intended as the main Microphone audio input for single microphone applications. In FRONTWAVE® operation, a multimicrophone signal is used to produce a directional hearing instrument response. The two audio inputs are buffered, sampled and converted into digital form using dual A/D converters. The digital outputs are converted into a 32kHz, 20-bit digital audio signal.

Further IIR filter blocks process the front microphone and rear microphone signals. Two biquad filters, "miccomp1" and "miccomp2", are used to match the rear microphone's gain and phase to that of the front microphone. After the miccomp filters, more filters are used to provide an adjustable group delay to create the desired polar response pattern during the calibration process.

In the Telecoil mode gains are trimmed during Cal/Config process to compensate for microphone/telecoil mismatches.

The FRONTWAVE® block is followed by two cascaded biquad filters, "pre1" and "pre2". These filters can be used for frequency response shaping before the signal goes from the CODEC chip into the DSP chip. When FRONTWAVE® is not enabled, the miccomp filters can be used for frequency response shaping also.

After passing through the biquad filters the signal enters the DSP chip. At this point, the signal is converted to 16kHz and 16-bit. The DSP chip runs the following signal processing algorithms:

- frequency analysis
- 4 channel WDRC
- 16 band frequency shaping
- 16 band noise reduction
- frequency band synthesis
- adaptive feedback cancellation

Once the signal has been processed by the DSP chip it goes back into the CODEC chip. On the CODEC chip there are four more cascaded biquad filters — "post1", "post2", "post3" and "post4". These biquad filters are followed by the tone generator, AGCo block and two more biquad filters — "postagco1" and "postagco2". The last stage in the signal path is the D/A H-bridge.

FUNCTIONAL BLOCK DESCRIPTION

ADAPTIVE FEEDBACK CANCELLER

The adaptive feedback canceller (AFC) reduces acoustic feedback by forming an estimate of the hearing aid feedback signal and then subtracting this estimate from the hearing aid input. Therefore the forward path of the hearing aid is not affected. Unlike adaptive notch filter approaches, DUET's AFC does not reduce the hearing aid's gain. The AFC is based on a time-domain model of the feedback path.

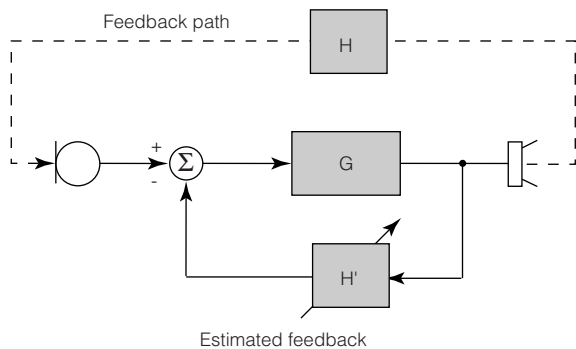

Figure 4: Adaptive Feedback Canceller (AFC) block diagram

ADAPTIVE NOISE REDUCTION

Noise reduction is applied independently in each of 16 frequency bands. The algorithm utilizes perceptual criteria to determine the audibility of individual noise bands. More attenuation is applied to those bands where the noise is most audible. Less attenuation is applied where the noise is inaudible. This maximizes the perceptual benefit of noise reduction and also reduces the audible artifacts that are often associated with adaptive noise reduction algorithms.

The attenuation applied to a given band is determined by a combination of two factors: the SNR and the masking threshold. The SNR estimate in each band determines the maximum amount of attenuation that will be applied to that band (the poorer the SNR the greater the amount of attenuation). At the same time the masking threshold resulting from the energy in adjacent bands is also estimated. Only enough attenuation is applied to bring the energy in each 'noise' band to just below the masking threshold. This prevents excessive amounts of attenuation from being applied and thereby reduces unwanted artifacts and distortion.

A/D AND D/A CONVERTERS

The system's two A/D converters are 2nd-order sigma-delta modulators, which operate at a 2.048MHz sample rate. The system's two audio inputs are pre-conditioned with antialias filtering and programmable gain pre-amplifiers. These analog outputs are over sampled and modulated to produce two, 1-bit pulse density modulated (PDM) data streams. The digital PDM data is then decimated down to pulse-code modulated (PCM) digital words at the system sampling rate of 32kHz.

The D/A is comprised of a digital, 3rd-order sigma-delta modulator and an H-bridge. The modulator accepts PCM audio data from the DSP path and converts it into a 32-times over-sampled, 1-bit PDM data stream, which is then supplied to the H-bridge. The H-bridge is a specialized CMOS output driver used to convert the 1-bit data stream into a low-impedance, differential output voltage waveform suitable for driving zero-biased hearing aid receivers.

HRX HEAD ROOM EXPANDER

The GB3212 has an enhanced Head Room Expander (HRX) circuit, which increases the input dynamic range of the DUET™ DIGITAL without any unwanted audible artifacts. This is accomplished by dynamically adjusting the preamplifier's gain and the post-A/D attenuation depending on the input level.

FRONTWAVE® DIRECTIONALITY

The FRONTWAVE® block provides the resources necessary to implement directional microphone processing. The block accepts inputs from both a front and rear microphone and provides a synthesized directional microphone signal as its output. The directional microphone output is obtained by delaying the rear microphone signal and subtracting it from the front microphone signal. Various microphone response patterns can be obtained by adjusting the time delay.

The FRONTWAVE® circuit also provides a fixed filter for compensating the sensitivity and frequency response differences between microphones. The filter parameters are adjusted during product calibration.

One of the generic IIR filters following the FRONTWAVE® block ("pre1") has been allocated for low frequency equalization to compensate for the 6dB/octave roll off in frequency response that occurs in directional mode. The amount of low frequency equalization that is applied can be determined during product calibration.

Gennum recommends using matched microphones with FRONTWAVE®, although calibration is fully possible using unmatched microphones. Initially, calibration using unmatched microphones will result in no difference in directionality. However, over a longer period of time unmatched microphones are more likely to drift apart and result in poor directional characteristics.

GENERIC BIQUAD FILTERS

Frequency shaping can be achieved by configuring generic biquad filters. The transfer function for each of the biquad filters is as follows:

$$H(z) = \frac{b_0 + b_1 * z^{-1} + b_2 * z^{-2}}{1 + a_1 * z^{-1} + a_2 * z^{-2}}$$

Note that the a0 coefficient is hard-wired to always be a 1. The coefficients are each 16 bits in length and include one sign bit, one bit to the left of the decimal point, and 14 bits to the right of the decimal point. Thus, before quantization, the floating-point coefficients must be in the range

$-2.0 \leq x < 2.0$ and quantized with the function:

$$\text{round}(x * 2^{14})$$

After designing a filter, the quantized coefficients can be entered into the PreBiquads or PostBiquads tab in the Interactive Data Sheet. The coefficients b0, b1, b2, a1, and a2 are as defined in the transfer function above. The parameters meta0 and meta1 do not have any effect on the signal processing, but can be used to store additional information related to the biquad with which they are associated.

The underlying code in the product components automatically checks all of the filters in the system for stability (that is, the poles have to be within the unit circle) before updating the graphs on the screen or programming the coefficients into the hybrid. If the Interactive Data Sheet receives an exception from the underlying stability checking code, it will automatically disable the biquad being modified and display a warning message. When the filter is made stable again, it can be re-enabled.

Note also that in some configurations some of these filters may be used by the product component for microphone/telecoil compensation, low-frequency EQ, etc. If this is the case, the coefficients the user enters into IDS will be ignored and the filter designed by the software will be programmed instead. For more information on filter design refer to [Biquad Filters In PARAGON™ Digital Hybrid](#) information note, Document # 20205.

VOLUME CONTROL

The volume control (VC) can be either external or programmable. If VC is programmed for external operation, a 200kΩ variable resistor should be connected to the 9bit A/D converter. Hysteresis is built into the Volume Control circuitry to prevent unintentional volume level toggling. A log taper potentiometer is recommended so that gain in dB will be linear with potentiometer rotation.

AGCO

The AGCo module is an output limiting circuit whose compression ratio is fixed at infinity:1. The threshold level is programmable. The AGCo module has its own twin level detector, with programmable attack and release time constants.

MS1 AND MS2 SWITCHES

There are two, two-pole Memory Select switches available on the GB3212, which allows the user tremendous flexibility in switching between configurations. These switches may be either momentary or static as set up in the Interactive Data Sheet.

Up to four memories can be configured. Enabled (valid) memories must be sequential. For example, if three memories were required, memories A, B and C would be enabled. Memory A must always be valid.

Momentary Switch on MS1

This mode uses a single momentary switch on MS (Pin 13) to change memories. Using this mode will cause the part to start in Memory A and whenever the button is pressed the next valid memory will be loaded. When the user is in the last valid memory, a button press will cause memory A to be loaded.

Examples:

If 4 valid memories ABCDABCD...

If 3 valid memories ABCABCA...

If 2 valid memories ABABA...

If 1 valid memories AAA...

Static Switch on MS1 and MS2

This mode uses two static switches to change memories. The following table describes which memory is selected depending on the state of the switches. In this mode it is possible to jump from any memory to any other memory simply by changing the state of both switches. If both switches are changed simultaneously then the transition will be smooth, otherwise, if one switch is changed and then the other, the part will transition to an intermediate memory before reaching the final memory. The part will start in whatever memory the switches are selecting. If a memory is invalid the part will not switch to the invalid memory, but stay in the current memory.

MS1	MS2	Memory
LOW	LOW	A
LOW	OPEN	B (if valid otherwise no change)
OPEN	LOW	C (if valid otherwise no change)
OPEN	OPEN	D (if valid otherwise no change)

Static Switch on MS1 Static Switch on MS2 (jump to memory D)

This mode uses two static switches to change memories. Unlike in the previous example, this mode will switch to memory D when the static switch on MS2 is OPEN. This means that this mode will only use a maximum of three memories (even if four valid memories are programmed). The following table describes which memory is selected depending on the state of the switches.

MS1	MS2	Memory
LOW	LOW	A
LOW	OPEN	D if valid otherwise no change)
OPEN	LOW	B (if valid otherwise no change)
OPEN	OPEN	D (if valid otherwise no change)

In this mode it is possible to jump from any memory to any other memory simply by changing the state of both switches. If both switches are changed simultaneously then the transition will be smooth, otherwise, if one switch is changed and then the other, the part will transition to an intermediate memory before reaching the final memory.

The part will start in whatever memory the switches are selecting. If the device starts up in a memory other than A, and the memory beep tones are enabled, the device will emit the corresponding tones for that memory. If a memory is invalid and the part starts up with the switches indicating this memory, the part will stay in memory A.

AUDIBLE MEMORY CHANGE INDICATOR

The DUET™ DIGITAL can be programmed to produce tones to indicate a memory change. Using the Interactive Data Sheet the GB3212 can be configured to either enable or disable the Memory Change Indicator.

When the Memory Change Indicator is enabled, there is an option to have a single beep for each memory change or multiple beeps.

The amplitude and frequency of the memory change tone can be selected independent of the Tone Generator settings and can be individually selected for each memory. When the memory change multiple beep is enabled and the memory change tone is enabled, then during a memory change operation the selected tone will beep a code to indicate which memory has been selected. The beep sequence will be 150ms ON followed by a 150ms OFF time between the beeps. The memory change beeping code is deciphered in the table below.

SELECTED MEMORY	# OF BEEPS
A	1
B	2
C	3
D	4

tone generator

The programmable tone generator is capable of producing programmable tones. Upon reception of the tone enable instruction, the DUET™ DIGITAL connects the output of the tone generator to the input of the D/A converter. The programmed tone is then output until a tone disable instruction is issued. When disabled, the normal audio signal is again connected.

WIDE DYNAMIC RANGE COMPRESSION

Any combination of adjacent frequency bands can be grouped to form four independent channels of compression. The I/O curve of each channel is divided into up to four regions (linear, compression, return to linear, clipping). The thresholds between these regions are adjustable over a wide range. Each channel has twin average detectors: a fast detector with a configurable time constant and a slow detector with a configurable time constant.

FREQUENCY SHAPING

The 16-band signal processor acts as a graphic equalizer. The gain of each band can be adjusted over 0 to -42dB range. The width of each band is 500Hz. The bands can be selected to have either an even or odd stacking arrangement. Selecting even stacking shifts the bands in unison by one half-band width (250Hz) effectively doubling the number of potential band edges. The default setting will be even stacking as this effectively results in one "extra" band since the nyquist band is "split" into two 250Hz bands, one from 0 to 250Hz the other from 7750Hz to 8000Hz.

LOW BATTERY INDICATOR (POWER-ON/POWER-OFF)

The DUET™ DIGITAL hybrids have two power management components on their controller chips: the Power-On-Reset sequence and turn off/end of battery life system.

The Power-On-Reset block's purpose is to ensure that a stable turn-on state is achieved. The blocks that are kept OFF are the A/D and preamp channels (both front and rear), the controller, the DSP chip, and the EEPROM power. A small portion of the controller is enabled to monitor the signals coming from the analog POR block. The audio output is muted when the supply voltage is below the turn-on threshold and during the power-on sequence.

An analog voltage comparator monitors the supply voltage and feeds its output to a digital timer whose purpose is to deglitch bouncy turn-ons. When the supply crosses the 1.1Vdc level (V_{BON}) the timer starts and if the supply voltage maintains a level above 1.0Vdc (V_{BOFF}) for at least 30ms, the disabled blocks will be enabled, else the timer is reset and waits for the analog comparator to signal that supply is again above V_{BON} . This ensures rejection of any turn on transients. Only after this 30ms finishes can the part start to download EEPROM configuration data, then configure and activate the DSP.

Once the part is ON, dropping the supply below V_{BON} causes the Lowbat signal to become active but otherwise the part continues to operate as normal. The Lowbat signal true condition requires that the supply voltage remain below V_{BON} for at least 30ms.

Once the Lowbat signal becomes active, the audible low battery voltage indicator will produce two consecutive beeps, 0.45 second long. These two beeps will repeat every 30 seconds. The communication with the hybrid is not possible when the beeps are being produced by the hybrid. The frequency and the amplitude of the beeps are programmable.

If the supply drops below 1.0Vdc (V_{BOFF}), then the part is put into an OFF state, there is no debouncing of this signal, and the action is immediate. This level was chosen since the regulator has a 950mV regulation voltage. The regulator needs some headroom to ensure that it maintains good supply rejection, which is critical in high gain, high power applications to prevent system instability.

The GB3212 operates in shallow-reset mode, during the power-on sequence circuit starts when the supply voltage rises above the turn-on threshold (V_{BON}) after shutdown. The device will function until the supply voltage drops below the turn-off threshold (V_{BOFF}) but will recover once the supply voltage rises above the turn-on threshold (V_{BON}) again.

POWER MANAGEMENT

The DUET™ DIGITAL was designed to accommodate high power applications. AC ripple on the supply can cause instantaneous reduction of the battery's voltage, potentially disruption the circuit's function. The GB3212 has a separate power supply and ground connection for the output stage. This allows hearing instrument designers to accommodate external RC filters in order to minimize any AC ripple from the supply line. Reducing this AC ripple greatly improves the stability of the circuit and prevents unwanted reset of

the circuit caused by spikes on the supply line. For more information on properly designing a filter to reduce supply ripple, please refer to information note [Using the GB3211 PARAGON Digital in High Power Application Initial Design Tips](#) document #24561.

PACKAGE DIMENSIONS

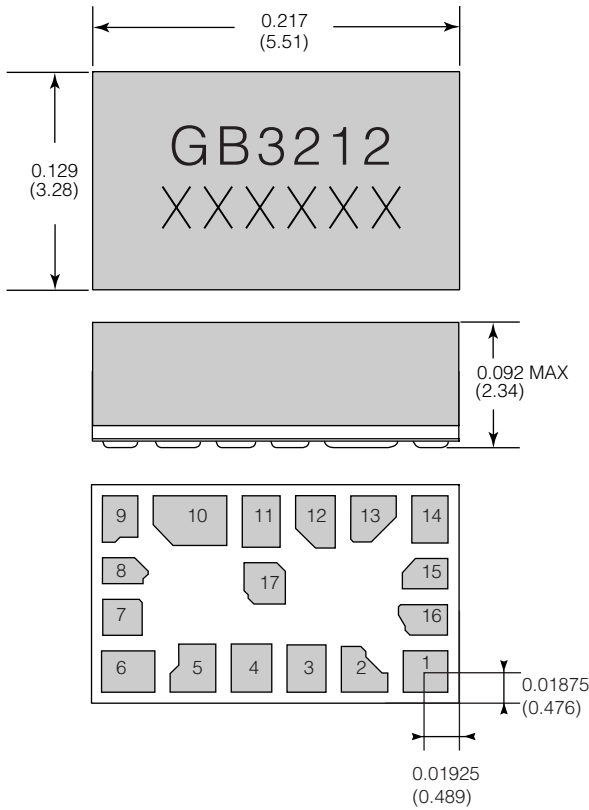

Dimension units are in inches.
 Dimensions in parentheses are in millimetres, converted from inches and include minor rounding errors.
 1.0000 inches = 25.400mm
 Dimension tolerances: ±0.003 (±0.08) unless otherwise stated.
 Work order number: XXXXXX
 This Hybrid is designed for either point-to-point manual soldering or for reflow according to Gennum's reflow process (Information Note 521-45).

PAD LOCATION

PAD NO.	PADPOSITION		PAD DIMENSION		
	X	Y	Xdim	Ydim	
1	0	0	26.5	24.5	MIL
2	-36	0	27.5	24.5	
3	-70.25	0	23	24.5	
4	-102.75	0	24	24.5	
5	-137.25	0	27	24.5	
6	-175.5	0	31.5	24.5	
7	-180.25	32	21	21.5	
8	-180.25	59.5	21	15.5	
9	-180.25	90	21	27.5	
10	-139	90	43.5	27.5	
11	-97	90	22.5	27.5	
12	-65	90	23.5	27.5	
13	-30.75	90	27	27.5	
14	2.5	89.75	21.5	28	
15	0	57.75	26.5	18	
16	0	30.5	26.5	18.5	
17	-95	52	24.5	24.5	
1	0	0	0.673	0.622	mm
2	-0.914	0	0.699	0.622	
3	-1.784	0	0.584	0.622	
4	-2.610	0	0.610	0.622	
5	-3.486	0	0.686	0.622	
6	-4.458	0	0.800	0.622	
7	-4.578	0.813	0.533	0.546	
8	-4.578	1.511	0.533	0.394	
9	-4.578	2.286	0.533	0.699	
10	-3.531	2.286	1.105	0.699	
11	-2.464	2.286	0.572	0.699	
12	-1.651	2.286	0.597	0.699	
13	-0.781	2.286	0.686	0.699	
14	0.064	2.280	0.546	0.711	
15	0	1.467	0.673	0.457	
16	0	0.775	0.673	0.470	
17	-2.413	1.321	0.622	0.622	

GB3212

DOCUMENT IDENTIFICATION
 PRELIMINARY DATA SHEET
 The product is in a preproduction phase and specifications are subject to change without notice.

REVISION NOTES:
 Corrected Package Dimensions drawing.
 For latest product information, visit www.gennum.com

GENNUM CORPORATION

MAILING ADDRESS:
 P.O. Box 489, Stn. A, Burlington, Ontario, Canada L7R 3Y3
 Tel. +1 (905) 632-2996 Fax. +1 (905) 632-5946

SHIPPING ADDRESS:
 970 Fraser Drive, Burlington, Ontario, Canada L7L 5P5

GENNUM JAPAN CORPORATION

Shinjuku Green Tower Building 27F, 6-14-1, Nishi Shinjuku,
 Shinjuku-ku, Tokyo, 160-0023 Japan
 Tel. +81 (03) 3349-5501, Fax. +81 (03) 3349-5505

Gennum Corporation assumes no responsibility for the use of any circuits described herein and makes no representations that they are free from patent infringement.

© Copyright May 2002 Gennum Corporation. All rights reserved. Printed in Canada.