

IRG4IBC10UDPbF

INSULATED GATE BIPOLAR TRANSISTOR WITH ULTRAFAST SOFT RECOVERY DIODE UltraFast Co-Pack IGBT

Features

- UltraFast: Optimized for high operating up to 80 kHz in hard switching, > 200 kHz in resonant mode
- Generation 4 IGBT design provides tighter parameter distribution and higher efficiency than previous generation
- IGBT co-packaged with HEXFRED[®] ultrafast, ultra-soft-recovery anti-parallel diodes for use in bridge configurations
- Industry standard TO-220 Full-Pak
- Lead-Free

Benefits

- Generation 4 IGBTs offer highest efficiencies available
- IGBTs optimized for specific application conditions
- HEXFRED[®] diodes optimized for performance with IGBTs
Minimized recovery characteristics require less/no snubbing

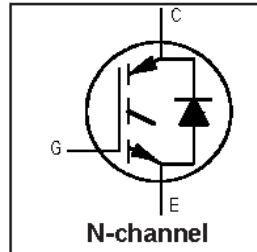

$V_{CES} = 600V$
$V_{CE(on) typ.} = 2.15V$
@ $V_{GE} = 15V, I_C = 5.0A$
$t_{f(typ.)} = 140ns$

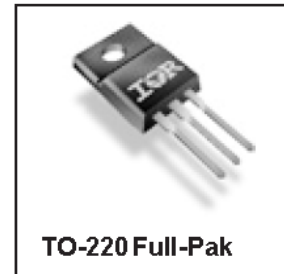

Absolute Maximum Ratings

	Parameter	Max.	Units
V_{CES}	Collector-to-Emitter Voltage	600	V
$I_C @ T_C = 25^\circ C$	Continuous Collector Current	6.8	A
$I_C @ T_C = 100^\circ C$	Continuous Collector Current	3.9	
I_{CM}	Pulsed Collector Current ①	27	
I_{LM}	Clamped Inductive Load Current ②	27	
$I_F @ T_C = 100^\circ C$	Diode Continuous Forward Current	3.9	
I_{FM}	Diode Maximum Forward Current	27	
V_{ISOL}	RMS Isolated Voltage, Terminal to case, t=1min	2500	V
V_{GE}	Gate-to-Emitter Voltage	± 20	
$P_D @ T_C = 25^\circ C$	Maximum Power Dissipation	25	W
$P_D @ T_C = 100^\circ C$	Maximum Power Dissipation	10	
T_J	Operating Junction and	-55 to +150	°C
T_{STG}	Storage Temperature Range		
	Soldering Temperature, for 10 sec	300 (0.063 in. (1.6mm) from case)	
	Mounting Torque, 6-32 or M3 Screw	10 lbf•in (1.1 N•m)	

Thermal Resistance

	Parameter	Typ.	Max.	Units
$R_{\theta JC}$	Junction-to-Case - IGBT	—	5.0	°C/W
$R_{\theta JC}$	Junction-to-Case - Diode	—	9.0	
$R_{\theta JA}$	Junction-to-Ambient, typical socket mount	—	65	
Wt	Weight	2.1 (0.075)	—	g (oz)

Electrical Characteristics @ $T_J = 25^\circ\text{C}$ (unless otherwise specified)

	Parameter	Min.	Typ.	Max.	Units	Conditions
$V_{(BR)CES}$	Collector-to-Emitter Breakdown Voltage ③	600	—	—	V	$V_{GE} = 0V, I_C = 250\mu A$
$DV_{(BR)CES}/DT_J$	Temperature Coeff. of Breakdown Voltage	—	0.54	—	V/°C	$V_{GE} = 0V, I_C = 1.0mA$
$V_{CE(on)}$	Collector-to-Emitter Saturation Voltage	—	2.15	2.6	V	$I_C = 5.0A$ $V_{GE} = 15V$ See Fig. 2, 5 $I_C = 8.5A$ $I_C = 5.0A, T_J = 150^\circ\text{C}$
		—	2.61	—		
		—	2.30	—		
$V_{GE(th)}$	Gate Threshold Voltage ④	3.0	—	6.0		$V_{CE} = V_{GE}, I_C = 250\mu A$
$DV_{GE(th)}/DT_J$	Temperature Coeff. of Threshold Voltage	—	-8.7	—	mV/°C	$V_{CE} = V_{GE}, I_C = 250\mu A$
g_{fe}	Forward Transconductance	2.8	4.2	—	S	$V_{CE} = 100V, I_C = 5.0A$
I_{CES}	Zero Gate Voltage Collector Current	—	—	250	μA	$V_{GE} = 0V, V_{CE} = 600V$ $V_{GE} = 0V, V_{CE} = 600V, T_J = 150^\circ\text{C}$
		—	—	1000		
V_{FM}	Diode Forward Voltage Drop	—	1.5	1.8	V	$I_C = 4.0A$ See Fig. 13 $I_C = 4.0A, T_J = 125^\circ\text{C}$
		—	1.4	1.7		
I_{GES}	Gate-to-Emitter Leakage Current	—	—	± 100	nA	$V_{GE} = \pm 20V$

Switching Characteristics @ $T_J = 25^\circ\text{C}$ (unless otherwise specified)

	Parameter	Min.	Typ.	Max.	Units	Conditions	
Q_g	Total Gate Charge (turn-on)	—	15	22	nC	$I_C = 5.0A$ $V_{CC} = 400V$ See Fig. 8 $V_{GE} = 15V$	
Q_{ge}	Gate - Emitter Charge (turn-on)	—	2.6	4.0			
Q_{gc}	Gate - Collector Charge (turn-on)	—	5.8	8.7			
$t_{d(on)}$	Turn-On Delay Time	—	40	—	ns	$T_J = 25^\circ\text{C}$ $I_C = 5.0A, V_{CC} = 480V$ $V_{GE} = 15V, R_G = 100W$ Energy losses include "tail" and diode reverse recovery. See Fig. 9, 10, 18	
t_r	Rise Time	—	16	—			
$t_{d(off)}$	Turn-Off Delay Time	—	87	130			
t_f	Fall Time	—	140	210			
E_{on}	Turn-On Switching Loss	—	0.14	—			
E_{off}	Turn-Off Switching Loss	—	0.12	—	mJ		
E_{ts}	Total Switching Loss	—	0.26	0.33			
$t_{d(on)}$	Turn-On Delay Time	—	38	—	ns	$T_J = 150^\circ\text{C}$ See Fig. 11, 18 $I_C = 5.0A, V_{CC} = 480V$ $V_{GE} = 15V, R_G = 100W$ Energy losses include "tail" and diode reverse recovery.	
t_r	Rise Time	—	18	—			
$t_{d(off)}$	Turn-Off Delay Time	—	95	—			
t_f	Fall Time	—	250	—			
E_{ts}	Total Switching Loss	—	0.45	—	mJ		
L_E	Internal Emitter Inductance	—	7.5	—	nH	Measured 5mm from package	
C_{ies}	Input Capacitance	—	270	—	pF	$V_{GE} = 0V$ $V_{CC} = 30V$ See Fig. 7 $f = 1.0MHz$	
C_{oes}	Output Capacitance	—	21	—			
C_{res}	Reverse Transfer Capacitance	—	3.5	—			
t_{rr}	Diode Reverse Recovery Time	—	28	42	ns	$T_J = 25^\circ\text{C}$ See Fig. 14 $T_J = 125^\circ\text{C}$ 14	$I_F = 4.0A$ $V_R = 200V$ $di/dt = 200A/\mu s$
		—	38	57			
I_{rr}	Diode Peak Reverse Recovery Current	—	2.9	5.2	A	$T_J = 25^\circ\text{C}$ See Fig. 15 $T_J = 125^\circ\text{C}$ 15	
		—	3.7	6.7			
Q_{rr}	Diode Reverse Recovery Charge	—	40	60	nC	$T_J = 25^\circ\text{C}$ See Fig. 16 $T_J = 125^\circ\text{C}$ 16	
		—	70	105			
$di_{(rec)M}/dt$	Diode Peak Rate of Fall of Recovery During t_b	—	280	—	A/ μs	$T_J = 25^\circ\text{C}$ See Fig. 17 $T_J = 125^\circ\text{C}$ 17	
		—	235	—			

Details of note ① through ④ are on the last page

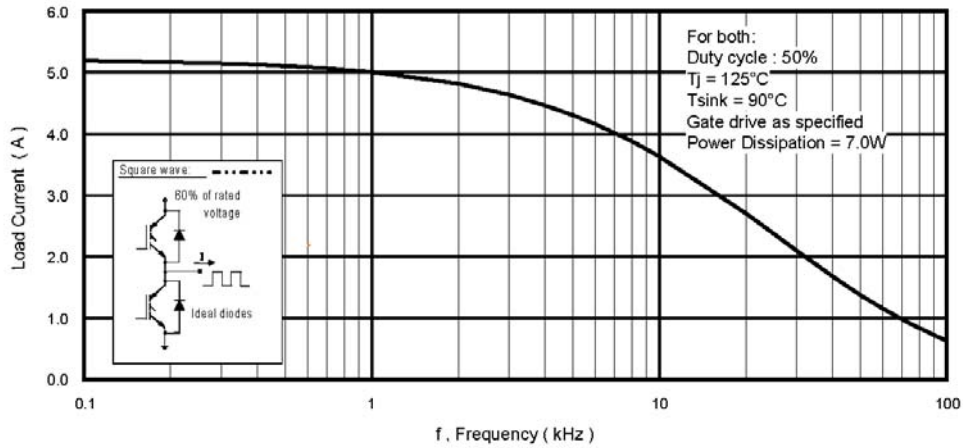

Fig. 1 - Typical Load Current vs. Frequency
(Load Current = I_{RMS} of fundamental)

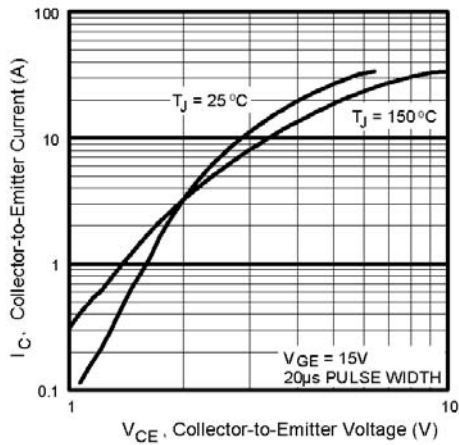

Fig. 2 - Typical Output Characteristics

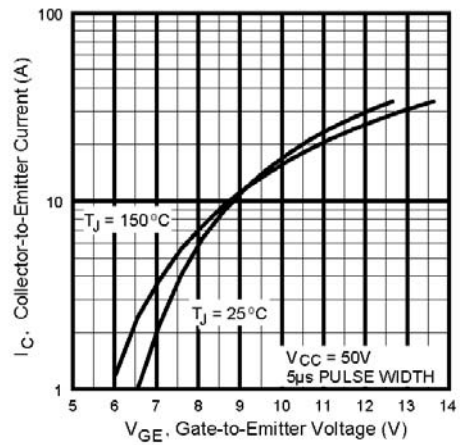

Fig. 3 - Typical Transfer Characteristics

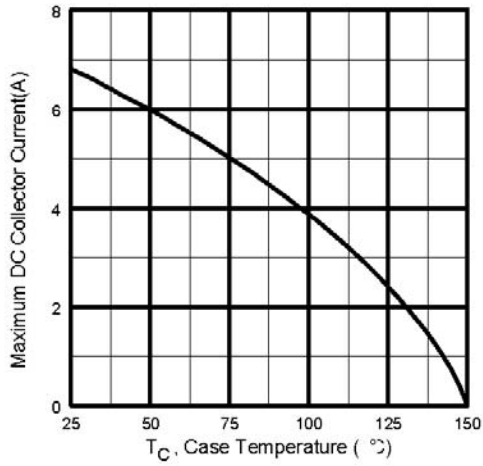

Fig. 4 - Maximum Collector Current vs. Case Temperature

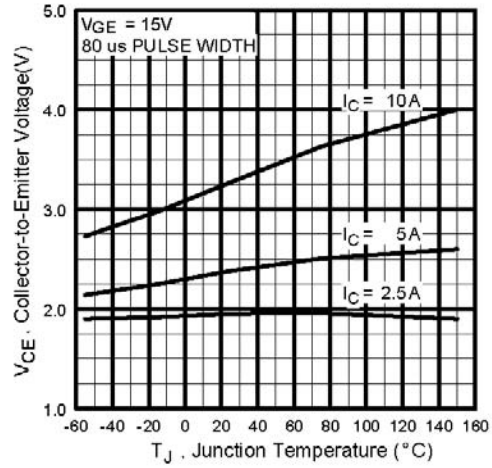

Fig. 5 - Typical Collector-to-Emitter Voltage vs. Junction Temperature

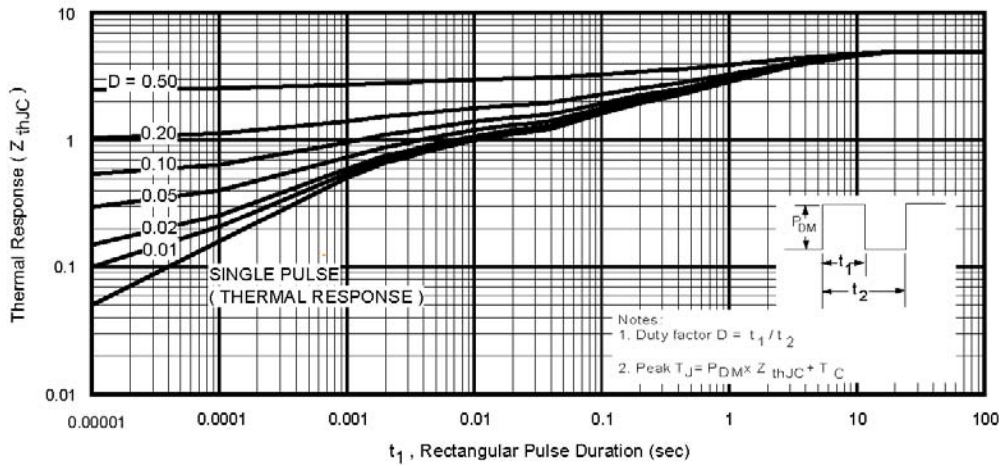

Fig. 6 - Maximum Effective Transient Thermal Impedance, Junction-to-Case

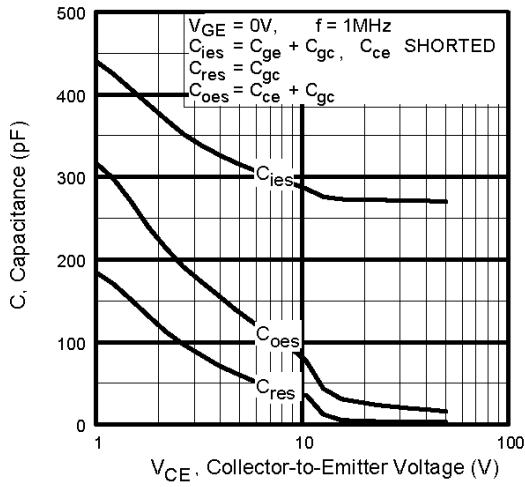

Fig. 7 - Typical Capacitance vs. Collector-to-Emitter Voltage

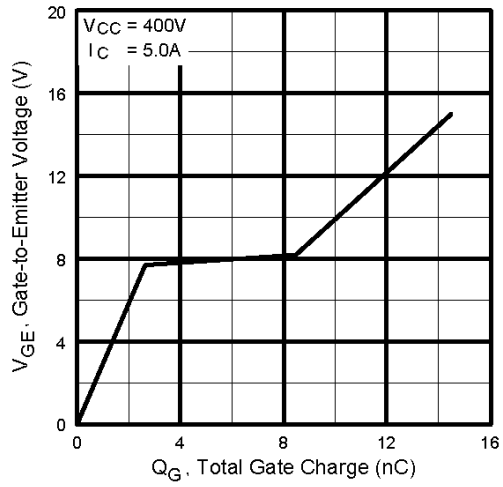

Fig. 8 - Typical Gate Charge vs. Gate-to-Emitter Voltage

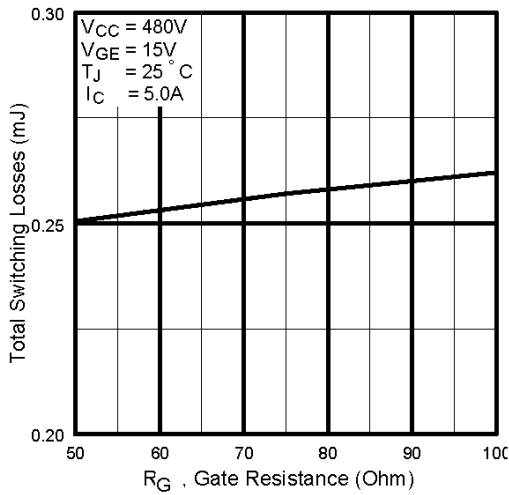

Fig. 9 - Typical Switching Losses vs. Gate Resistance

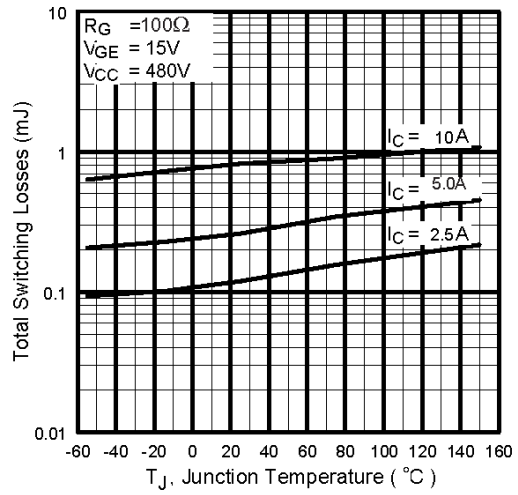

Fig. 10 - Typical Switching Losses vs. Junction Temperature

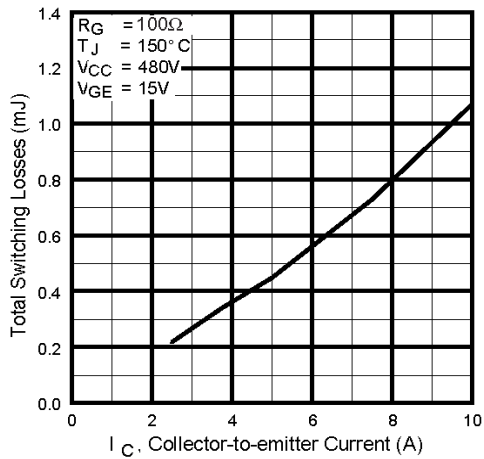

Fig. 11 - Typical Switching Losses vs. Collector-to-Emitter Current

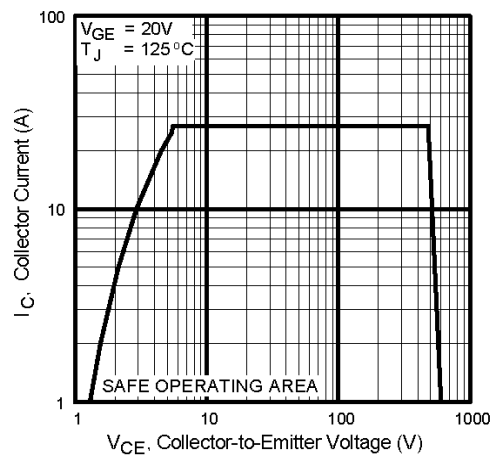

Fig. 12 - Turn-Off SOA

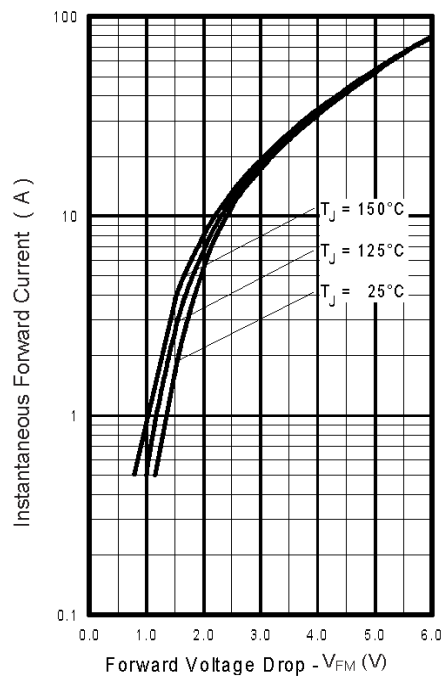

Fig. 13 - Maximum Forward Voltage Drop vs. Instantaneous Forward Current

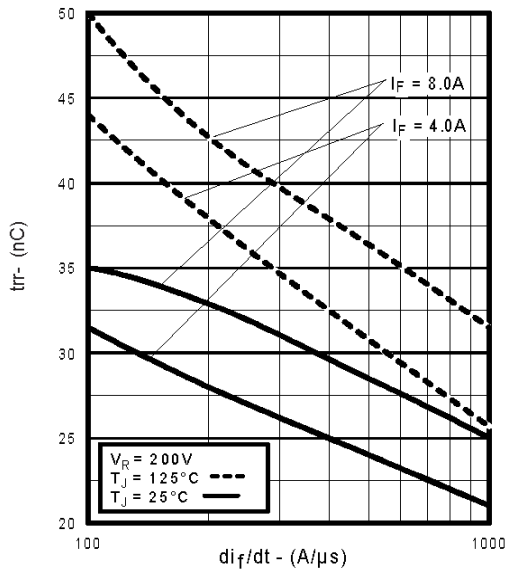

Fig. 14 - Typical Reverse Recovery vs. di_f/dt

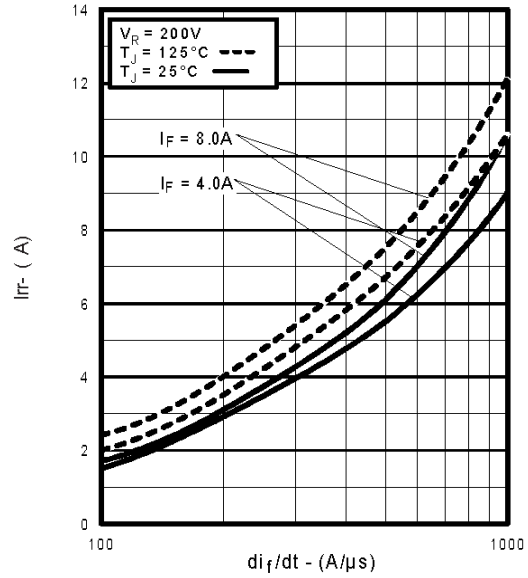

Fig. 15 - Typical Recovery Current vs. di_f/dt

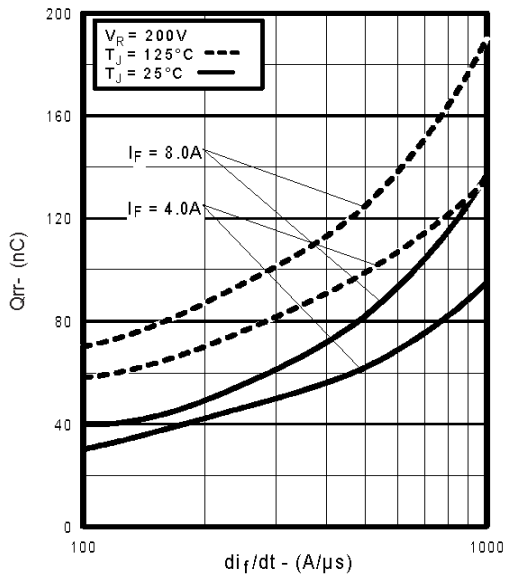

Fig. 16 - Typical Stored Charge vs. di_f/dt

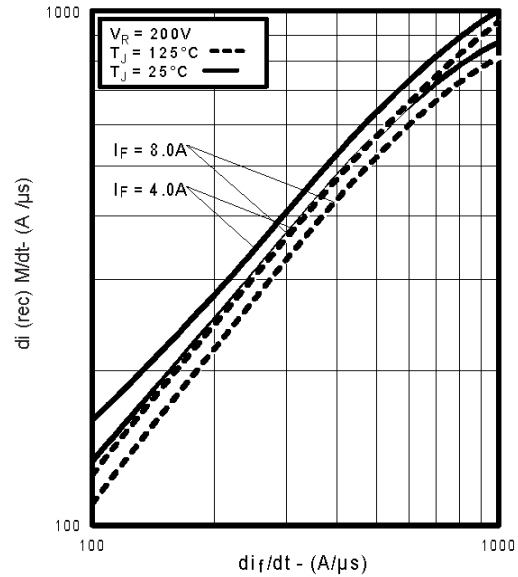

Fig. 17 - Typical $di_{(rec)M}/dt$ vs. di_f/dt

IRG4IBC10UDPbF

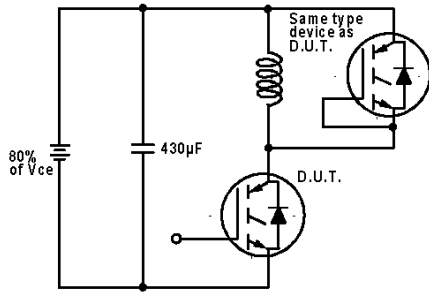

Fig. 18a - Test Circuit for Measurement of I_{LM} , E_{on} , $E_{off}(\text{diode})$, t_{rr} , Q_{rr} , I_{rr} , $t_{d(on)}$, t_r , $t_{d(off)}$, t_f

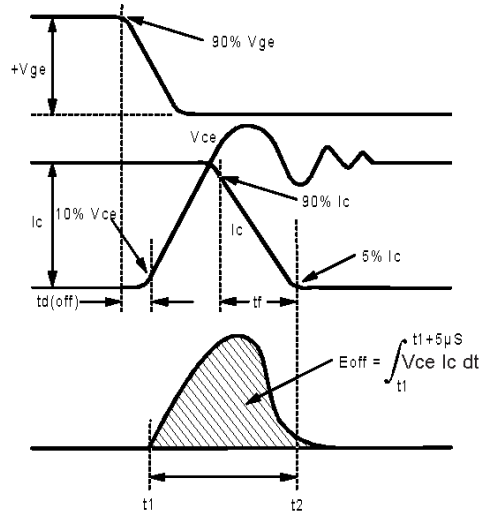

Fig. 18b - Test Waveforms for Circuit of Fig. 18a, Defining E_{off} , $t_{d(off)}$, t_f

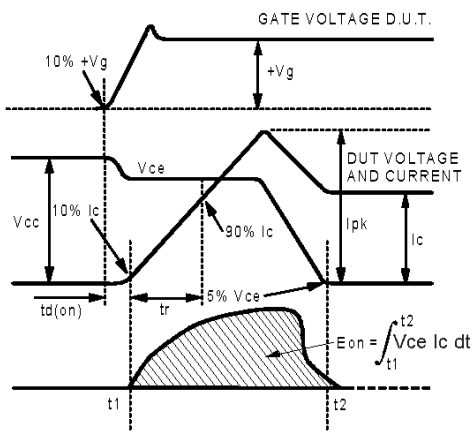

Fig. 18c - Test Waveforms for Circuit of Fig. 18a, Defining E_{on} , $t_{d(on)}$, t_r

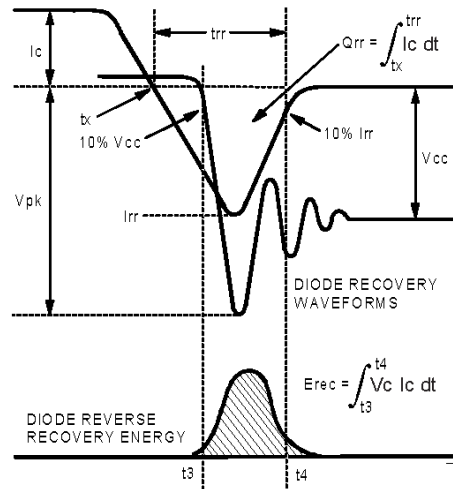

Fig. 18d - Test Waveforms for Circuit of Fig. 18a, Defining E_{rec} , t_{rr} , Q_{rr} , I_{rr}

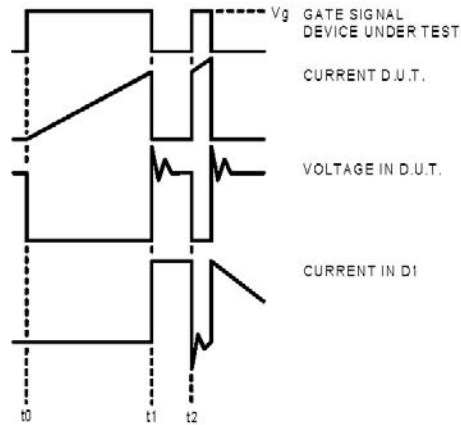

Fig. 18e - Macro Waveforms for Figure 18a's Test Circuit

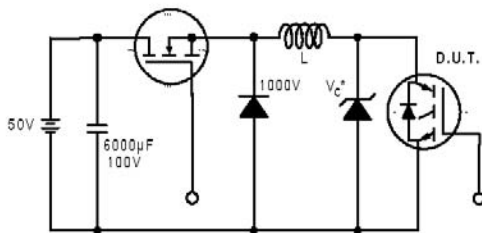

Fig. 19 - Clamped Inductive Load Test Circuit

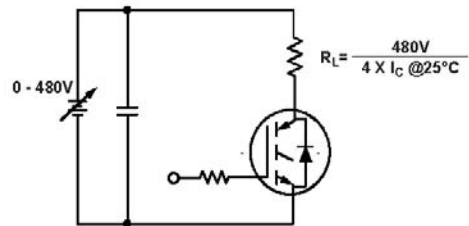

Fig. 20 - Pulsed Collector Current Test Circuit

IRG4IBC10UDPbF



TO-220 Full-Pak Package Outline

Dimensions are shown in millimeters (inches)

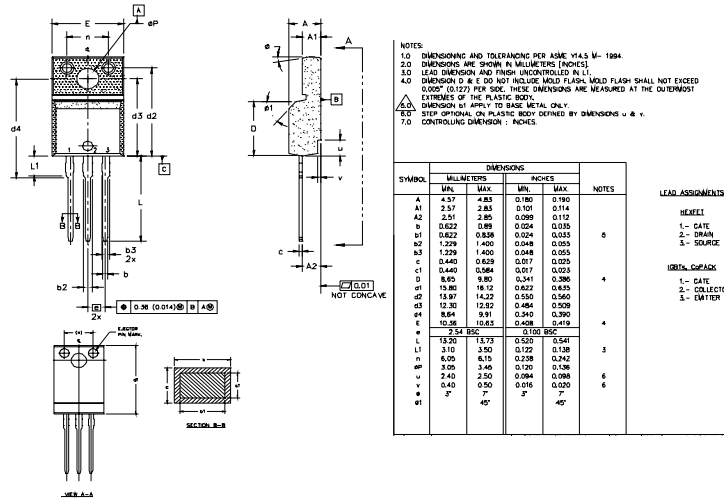

TO-220 Full-Pak Part Marking Information

EXAMPLE: THIS IS AN IRF1840G
 WITH ASSEMBLY
 LOT CODE 3432
 ASSEMBLED ON WW 24 1999
 IN THE ASSEMBLY LINE "K"
Note: "P" in assembly line
 position indicates "Lead-Free"

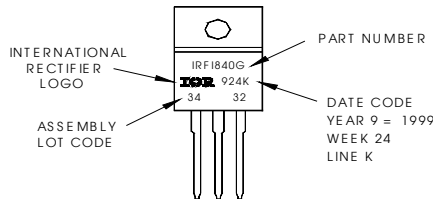

Notes

- ① Repetitive rating: $V_{GE}=20V$; Pulse width limited by maximum junction temperature (figure 20)
- ② $V_{CC}=80\%(V_{CES})$, $V_{GE}=20V$, $L=10\mu H$, $R_G=100\Omega$ (figure 19)
- ③ Pulse width $\leq 80\mu s$, duty factor $\leq 0.1\%$.
- ④ Pulse width $5.0\mu s$, single shot.

Data and specifications subject to change without notice.



IR WORLD HEADQUARTERS: 233 Kansas St., El Segundo, California 90245, USA Tel: (310) 252-7105
 TAC Fax: (310) 252-7903
 Visit us at www.irf.com for sales contact information.07/04
www.irf.com