

HighSpeed 2-Technology with soft, fast recovery anti-parallel EmCon HE diode

- **Designed for:**
 - SMPS
 - Lamp Ballast
 - ZVS-Converter
 - optimised for soft-switching / resonant topologies
- **2nd generation HighSpeed-Technology for 1200V applications offers:**
 - loss reduction in resonant circuits
 - temperature stable behavior
 - parallel switching capability
 - tight parameter distribution
 - E_{off} optimized for $I_C=1A$

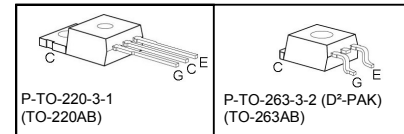
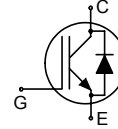

- Complete product spectrum and PSpice Models : <http://www.infineon.com/igbt/>

Type	V_{CE}	I_C	E_{off}	T_j	Package	Ordering Code
IKP01N120H2	1200V	1A	0.09mJ	150°C	P-TO-220-3-1	Q67040-S4589
IKB01N120H2	1200V	1A	0.09mJ	150°C	P-TO-263 (D ² PAK)	Q67040-S4590

Maximum Ratings

Parameter	Symbol	Value	Unit
Collector-emitter voltage	V_{CE}	1200	V
Triangular collector current	I_C		A
$T_C = 25^\circ\text{C}, f = 140\text{kHz}$		3.2	
$T_C = 100^\circ\text{C}, f = 140\text{kHz}$		1.3	
Pulsed collector current, t_p limited by T_{jmax}	I_{Cpuls}	3.5	
Turn off safe operating area	-	3.5	
$V_{CE} \leq 1200\text{V}, T_j \leq 150^\circ\text{C}$			
Diode forward current	I_F		
$T_C = 25^\circ\text{C}$		3.2	
$T_C = 100^\circ\text{C}$		1.3	
Gate-emitter voltage	V_{GE}	± 20	V
Power dissipation	P_{tot}	28	W
$T_C = 25^\circ\text{C}$			
Operating junction and storage temperature	T_j, T_{stg}	-40...+150	°C
Soldering temperature, 1.6mm (0.063 in.) from case for 10s	-	260 225 (for SMD)	

Thermal Resistance

Parameter	Symbol	Conditions	Max. Value	Unit
Characteristic				
IGBT thermal resistance, junction – case	R_{thJC}		4.5	K/W
Diode thermal resistance, Junction - case	R_{thJCD}		11	
Thermal resistance, junction – ambient	R_{thJA}	P-TO-220-3-1	62	
SMD version, device on PCB ¹⁾	R_{thJA}	P-TO-263 (D ² PAK)	40	

Electrical Characteristic, at $T_j = 25^\circ\text{C}$, unless otherwise specified

Parameter	Symbol	Conditions	Value			Unit
			min.	Typ.	max.	
Static Characteristic						
Collector-emitter breakdown voltage	$V_{(BR)CES}$	$V_{GE}=0V, I_C=300\mu A$	1200	-	-	V
Collector-emitter saturation voltage	$V_{CE(sat)}$	$V_{GE} = 15V, I_C=1A$ $T_j=25^\circ\text{C}$ $T_j=150^\circ\text{C}$	-	2.2	2.8	
			-	2.5	-	
			-	2.4	-	
Gate-emitter threshold voltage	$V_{GE(th)}$	$I_C=30\mu A, V_{CE}=V_{GE}$	2.1	3	3.9	
Zero gate voltage collector current	I_{CES}	$V_{CE}=1200V, V_{GE}=0V$ $T_j=25^\circ\text{C}$ $T_j=150^\circ\text{C}$	-	-	20	μA
			-	-	80	
Diode forward voltage	V_F	$V_{GE} = 0, I_F=0.5A$ $T_j=25^\circ\text{C}$ $T_j=150^\circ\text{C}$	-	2.0	2.5	V
			-	1.75	-	
Gate-emitter leakage current	I_{GES}	$V_{CE}=0V, V_{GE}=20V$	-	-	40	nA
Transconductance	g_{fs}	$V_{CE}=20V, I_C=1A$	-	0.75	-	S
Dynamic Characteristic						
Input capacitance	C_{iss}	$V_{CE}=25V,$ $V_{GE}=0V,$ $f=1\text{MHz}$	-	91.6	-	pF
Output capacitance	C_{oss}		-	9.8	-	
Reverse transfer capacitance	C_{rfs}		-	3.4	-	
Gate charge	Q_{Gate}	$V_{CC}=960V, I_C=1A$ $V_{GE}=15V$	-	8.6	-	nC
Internal emitter inductance measured 5mm (0.197 in.) from case	L_E	P-TO-220-3-1	-	7	-	nH
		P-TO-247-3-1	-	13	-	

¹⁾ Device on 50mm*50mm*1.5mm epoxy PCB FR4 with 6cm² (one layer, 70 μ m thick) copper area for collector connection. PCB is vertical without blown air.

Switching Characteristic, Inductive Load, at $T_j=25^\circ\text{C}$

Parameter	Symbol	Conditions	Value			Unit
			min.	Typ.	max.	
IGBT Characteristic						
Turn-on delay time	$t_{d(\text{on})}$	$T_j=25^\circ\text{C}$,	-	13	-	ns
Rise time	t_r	$V_{\text{CC}}=800\text{V}$,	-	6.3	-	
Turn-off delay time	$t_{d(\text{off})}$	$I_{\text{C}}=1\text{A}$,	-	370	-	
Fall time	t_f	$V_{\text{GE}}=15\text{V}/0\text{V}$,	-	28	-	
Turn-on energy	E_{on}	$R_{\text{G}}=241\Omega$,	-	0.08	-	mJ
Turn-off energy	E_{off}	$L_{\sigma}^{2)}=180\text{nH}$,	-	0.06	-	
Total switching energy	E_{ts}	$C_{\sigma}^{2)}=40\text{pF}$ Energy losses include "tail" and diode ³⁾ reverse recovery.	-	0.14	-	

Anti-Parallel Diode Characteristic

Diode reverse recovery time	t_{rr}	$T_j=25^\circ\text{C}$,	-	83	-	ns
Diode reverse recovery charge	Q_{rr}	$V_{\text{R}}=800\text{V}$, $I_{\text{F}}=1\text{A}$,	-	89	-	μC
Diode peak reverse recovery current	I_{rrm}	$R_{\text{G}}=241\Omega$	-	2.5	-	A
Diode current slope	di_{F}/dt		-	289	-	A/ μs
Diode peak rate of fall of reverse recovery current during t_{b}	di_{rr}/dt		-	178	-	

Switching Characteristic, Inductive Load, at $T_j=150^\circ\text{C}$

Parameter	Symbol	Conditions	Value			Unit
			min.	Typ.	max.	
IGBT Characteristic						
Turn-on delay time	$t_{d(\text{on})}$	$T_j=150^\circ\text{C}$	-	12	-	ns
Rise time	t_r	$V_{\text{CC}}=800\text{V}$,	-	8.9	-	
Turn-off delay time	$t_{d(\text{off})}$	$I_{\text{C}}=1\text{A}$,	-	450	-	
Fall time	t_f	$V_{\text{GE}}=15\text{V}/0\text{V}$,	-	43	-	
Turn-on energy	E_{on}	$R_{\text{G}}=241\Omega$,	-	0.11	-	mJ
Turn-off energy	E_{off}	$L_{\sigma}^{2)}=180\text{nH}$,	-	0.09	-	
Total switching energy	E_{ts}	$C_{\sigma}^{2)}=40\text{pF}$ Energy losses include "tail" and diode ³⁾ reverse recovery.	-	0.2	-	

Anti-Parallel Diode Characteristic

Diode reverse recovery time	t_{rr}	$T_j=150^\circ\text{C}$	-	213	-	ns
Diode reverse recovery charge	Q_{rr}	$V_{\text{R}}=800\text{V}$, $I_{\text{F}}=1\text{A}$,	-	180	-	μC
Diode peak reverse recovery current	I_{rrm}	$R_{\text{G}}=241\Omega$	-	2.7	-	A
Diode current slope	di_{F}/dt		-	240	-	A/ μs
Diode peak rate of fall of reverse recovery current during t_{b}	di_{rr}/dt		-	135	-	

²⁾ Leakage inductance L_{σ} and stray capacity C_{σ} due to dynamic test circuit in figure E

³⁾ Commutation diode from device IKP01N120H2

Switching Energy ZVT, Inductive Load

Parameter	Symbol	Conditions	Value			Unit
			min.	typ.	max.	
IGBT Characteristic						
Turn-off energy	E_{off}	$V_{CC}=800V,$ $I_C=1A,$ $V_{GE}=15V/0V,$ $R_G=241\Omega,$ $C_r^{2)}=1nF$ $T_j=25^\circ C$ $T_j=150^\circ C$	-	0.02	-	mJ
			-	0.044	-	

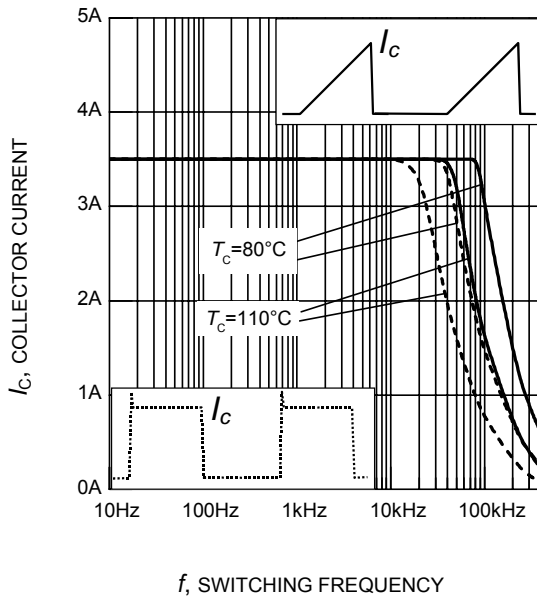

Figure 1. Collector current as a function of switching frequency
 ($T_j \leq 150^\circ\text{C}$, $D = 0.5$, $V_{CE} = 800\text{V}$,
 $V_{GE} = +15\text{V}/0\text{V}$, $R_G = 241\Omega$)

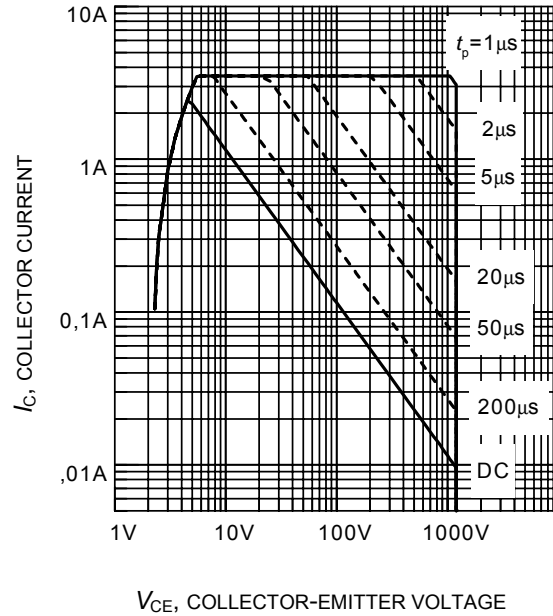

Figure 2. Safe operating area
 ($D = 0$, $T_C = 25^\circ\text{C}$, $T_j \leq 150^\circ\text{C}$)

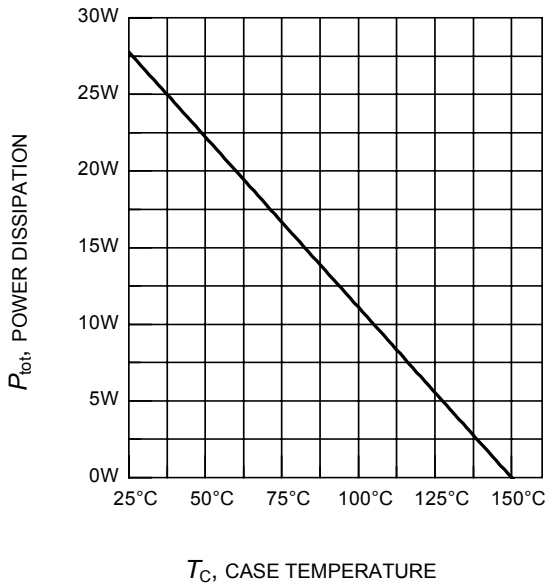

Figure 3. Power dissipation as a function of case temperature
 ($T_j \leq 150^\circ\text{C}$)

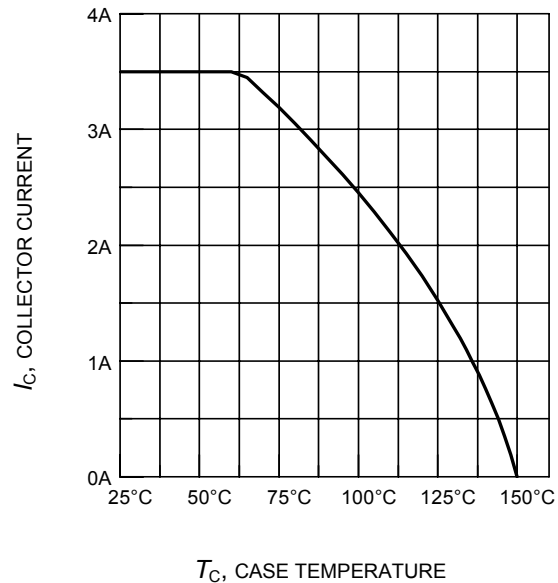
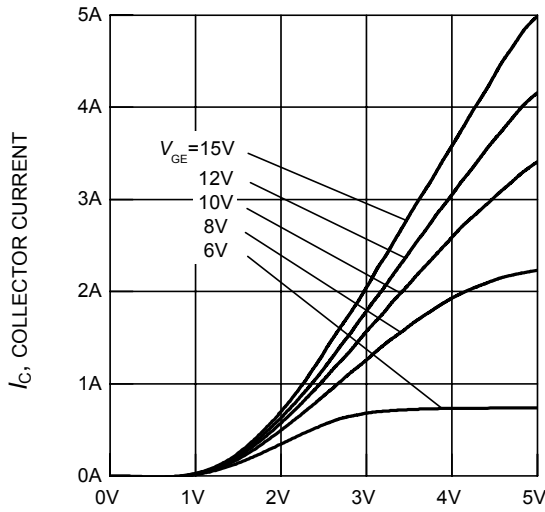
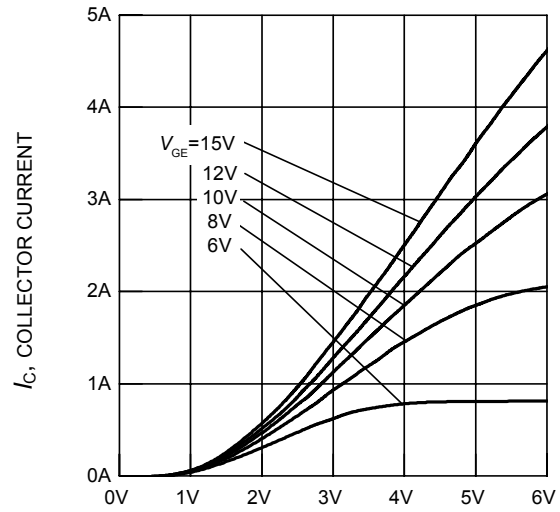

Figure 4. Collector current as a function of case temperature
 ($V_{GE} \leq 15\text{V}$, $T_j \leq 150^\circ\text{C}$)



V_{CE} , COLLECTOR-EMITTER VOLTAGE
Figure 5. Typical output characteristics
 $(T_j = 25^\circ\text{C})$



V_{CE} , COLLECTOR-EMITTER VOLTAGE
Figure 6. Typical output characteristics
 $(T_j = 150^\circ\text{C})$

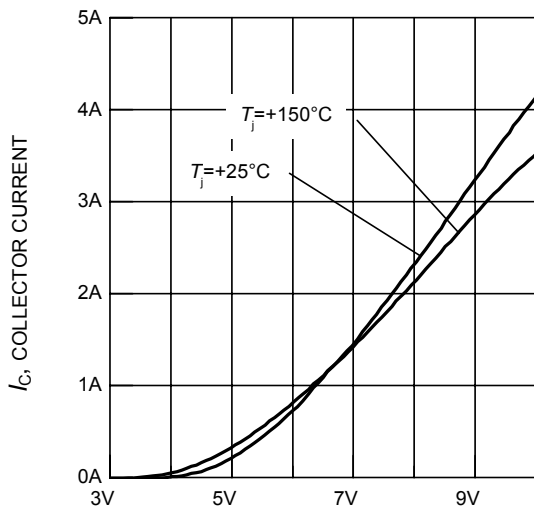

V_{GE} , GATE-EMITTER VOLTAGE
Figure 7. Typical transfer characteristics
 $(V_{CE} = 20\text{V})$

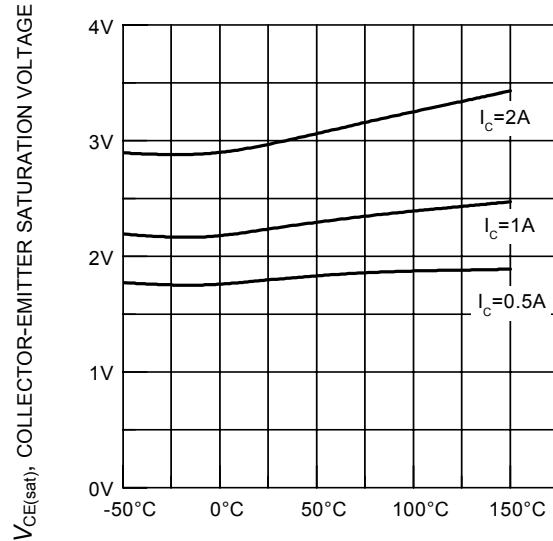

T_j , JUNCTION TEMPERATURE
Figure 8. Typical collector-emitter saturation voltage as a function of junction temperature
 $(V_{GE} = 15\text{V})$

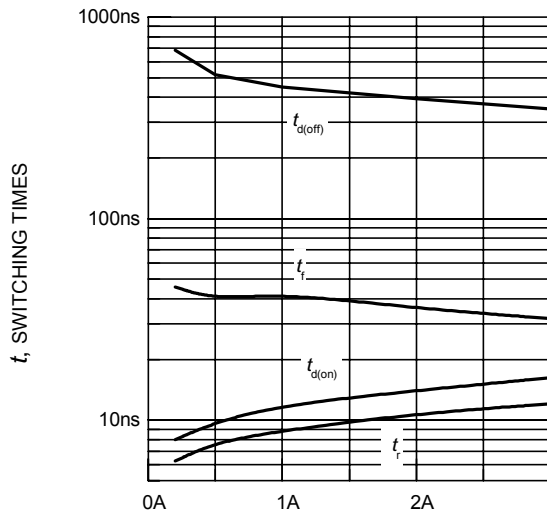

I_C , COLLECTOR CURRENT

Figure 9. Typical switching times as a function of collector current

(inductive load, $T_j = 150^\circ\text{C}$, $V_{CE} = 800\text{V}$, $V_{GE} = +15\text{V}/0\text{V}$, $R_G = 241\Omega$, dynamic test circuit in Fig.E)

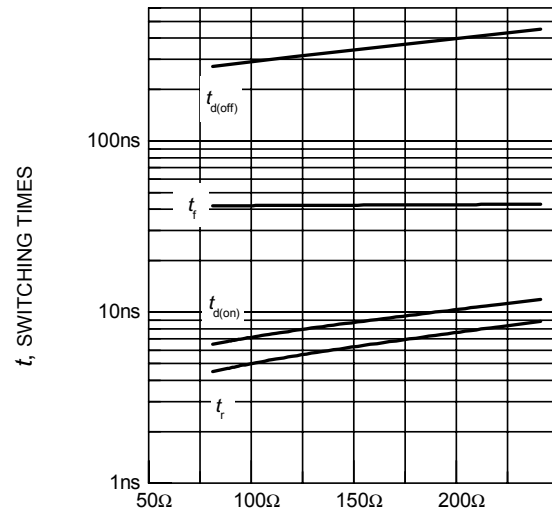

R_G , GATE RESISTOR

Figure 10. Typical switching times as a function of gate resistor

(inductive load, $T_j = 150^\circ\text{C}$, $V_{CE} = 800\text{V}$, $V_{GE} = +15\text{V}/0\text{V}$, $I_C = 1\text{A}$, dynamic test circuit in Fig.E)

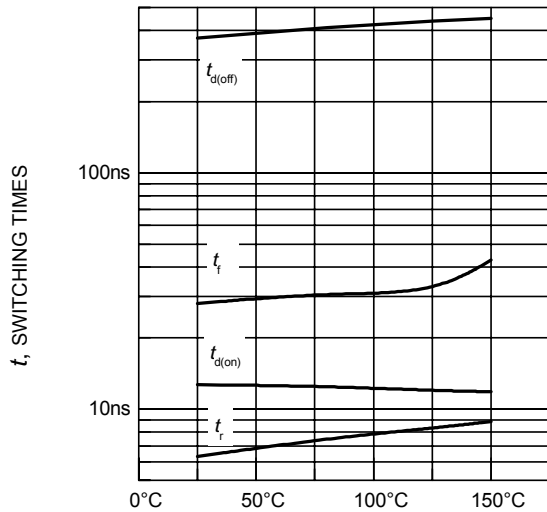

T_j , JUNCTION TEMPERATURE

Figure 11. Typical switching times as a function of junction temperature

(inductive load, $V_{CE} = 800\text{V}$, $V_{GE} = +15\text{V}/0\text{V}$, $I_C = 1\text{A}$, $R_G = 241\Omega$, dynamic test circuit in Fig.E)

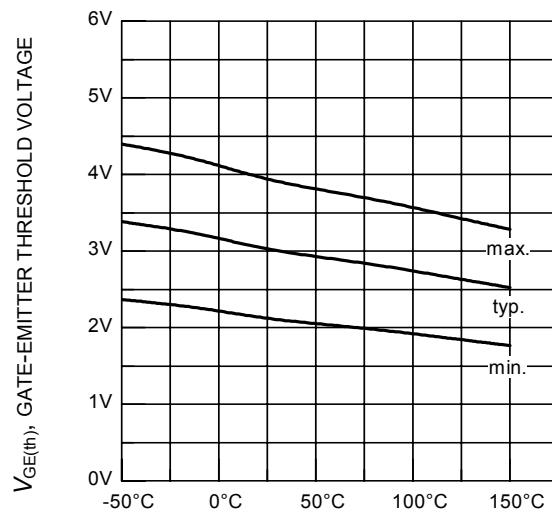

T_j , JUNCTION TEMPERATURE

Figure 12. Gate-emitter threshold voltage as a function of junction temperature

($I_C = 0.03\text{mA}$)

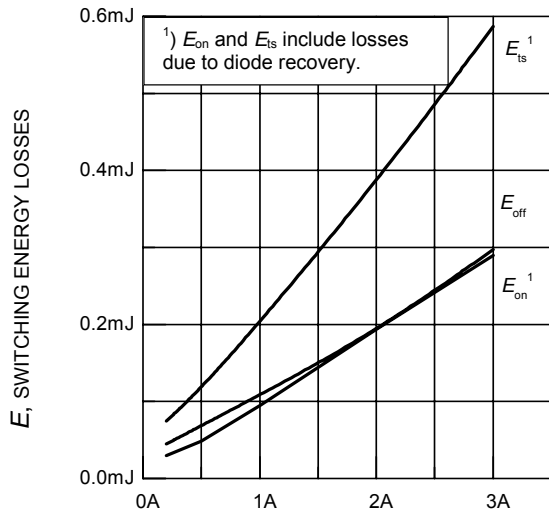

I_C , COLLECTOR CURRENT

Figure 13. Typical switching energy losses as a function of collector current
(inductive load, $T_j = 150^\circ\text{C}$, $V_{CE} = 800\text{V}$, $V_{GE} = +15\text{V}/0\text{V}$, $R_G = 241\Omega$, dynamic test circuit in Fig.E)

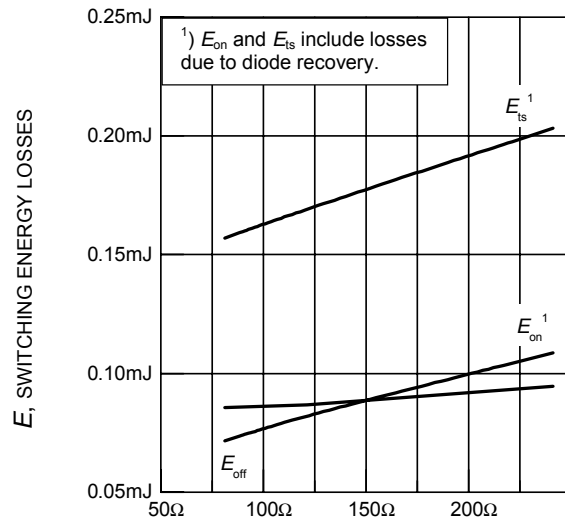

R_G , GATE RESISTOR

Figure 14. Typical switching energy losses as a function of gate resistor
(inductive load, $T_j = 150^\circ\text{C}$, $V_{CE} = 800\text{V}$, $V_{GE} = +15\text{V}/0\text{V}$, $I_C = 1\text{A}$, dynamic test circuit in Fig.E)

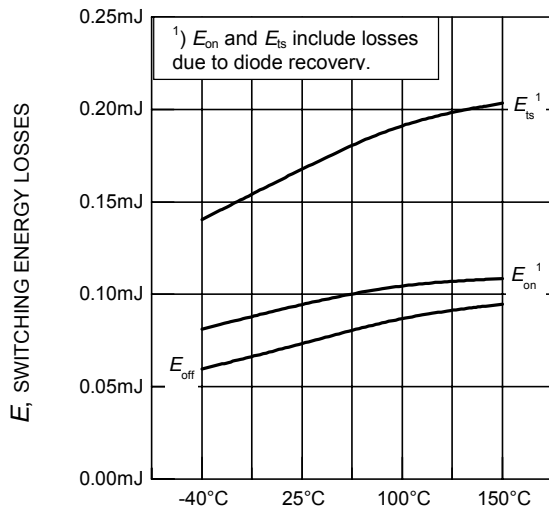

T_j , JUNCTION TEMPERATURE

Figure 15. Typical switching energy losses as a function of junction temperature
(inductive load, $V_{CE} = 800\text{V}$, $V_{GE} = +15\text{V}/0\text{V}$, $I_C = 1\text{A}$, $R_G = 241\Omega$, dynamic test circuit in Fig.E)

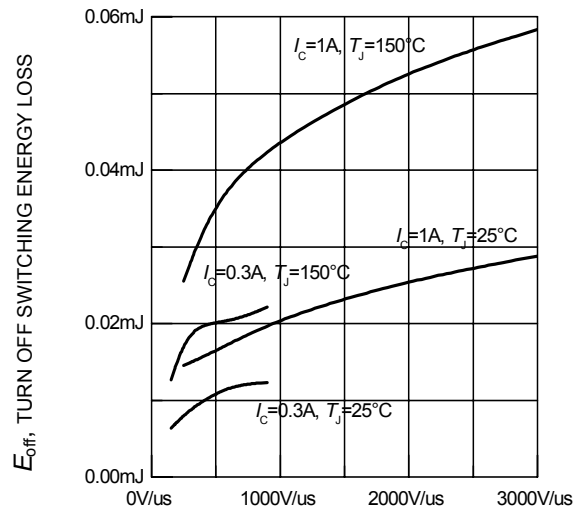

dv/dt , VOLTAGE SLOPE

Figure 16. Typical turn off switching energy loss for soft switching
(dynamic test circuit in Fig. E)

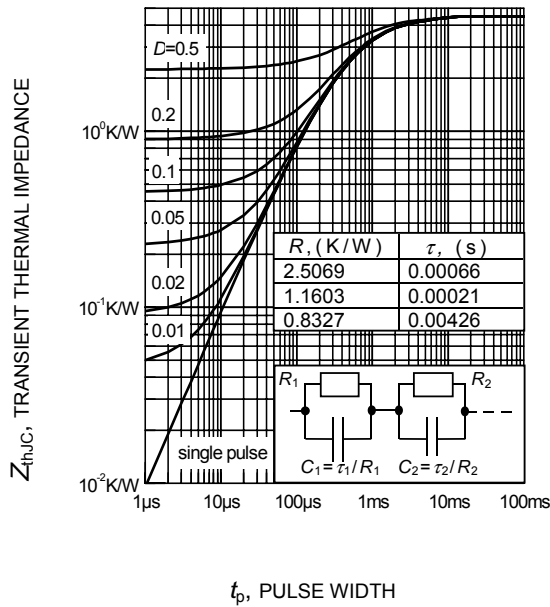

Figure 17. IGBT transient thermal impedance as a function of pulse width
($D = t_p / T$)

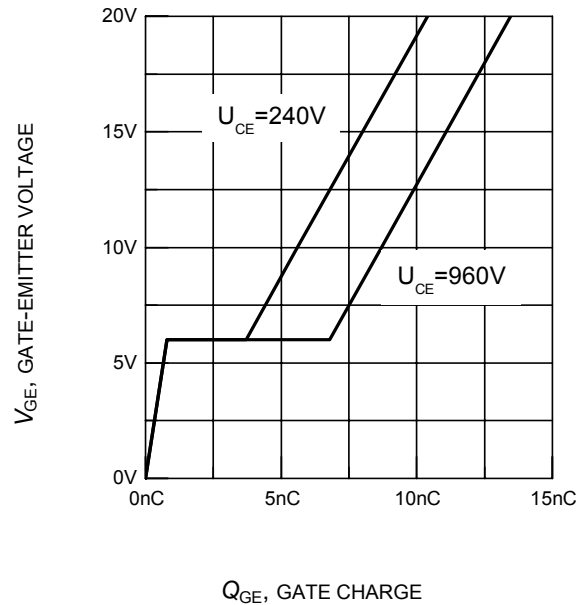

Figure 18. Typical gate charge
($I_C = 1A$)

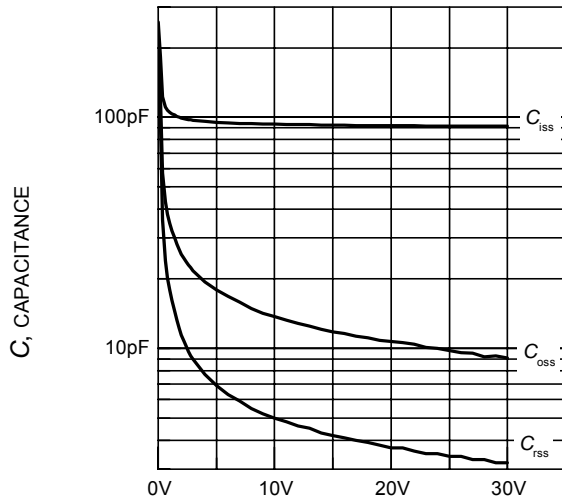

Figure 19. Typical capacitance as a function of collector-emitter voltage
($V_{GE} = 0V, f = 1MHz$)

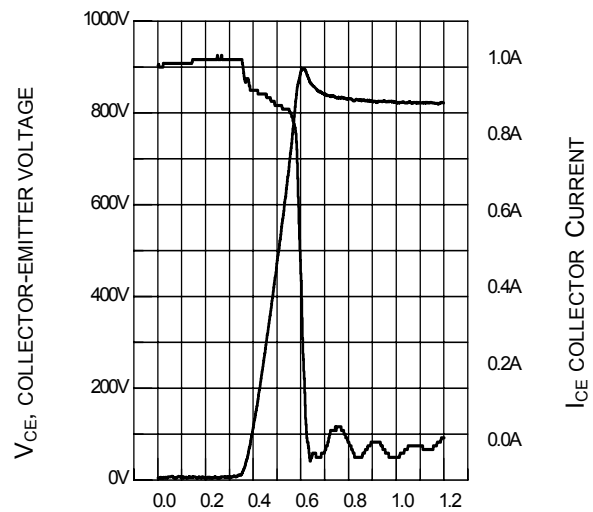

Figure 20. Typical turn off behavior, hard switching
($V_{GE}=15/0V, R_G=220\Omega, T_j = 150^\circ C,$
Dynamic test circuit in Figure E)

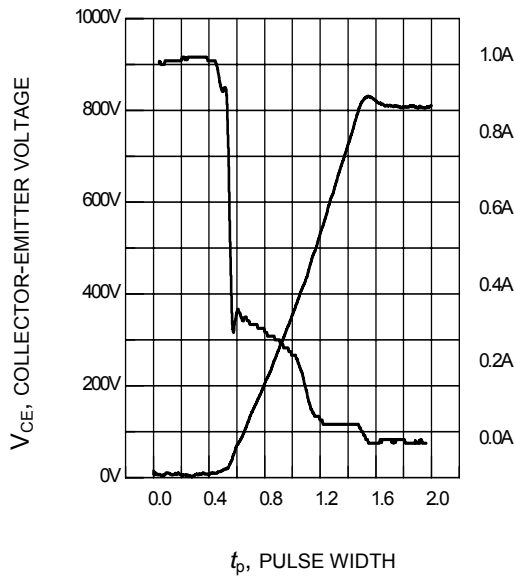

Figure 21. Typical turn off behavior, soft switching
 ($V_{GE}=15/0V$, $R_G=220\Omega$, $T_j = 150^\circ C$,
 Dynamic test circuit in Figure E)

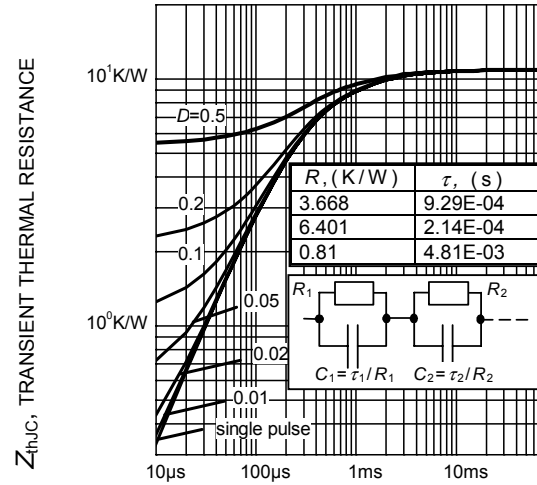

Figure 22. Diode transient thermal impedance as a function of pulse width
 ($D=t_p/T$)

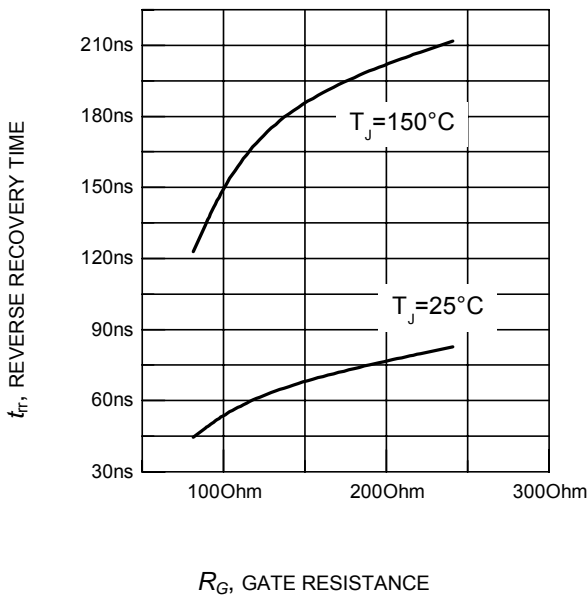

Figure 23. Typical reverse recovery time as a function of diode current slope
 ($V_R=800V$, $I_F=3A$,
 Dynamic test circuit in Figure E)

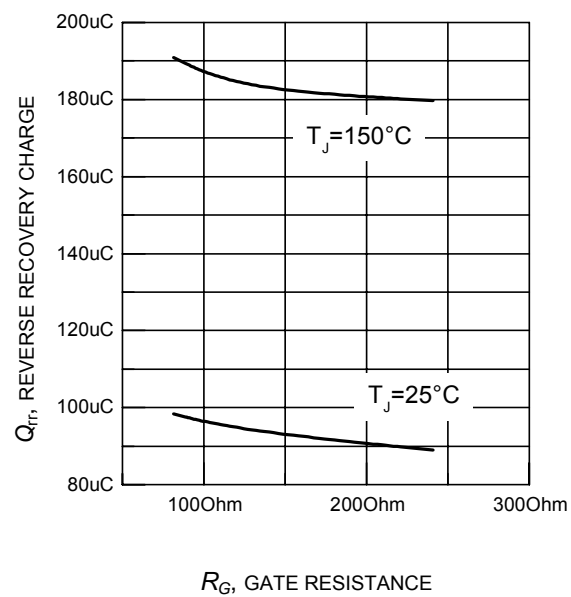
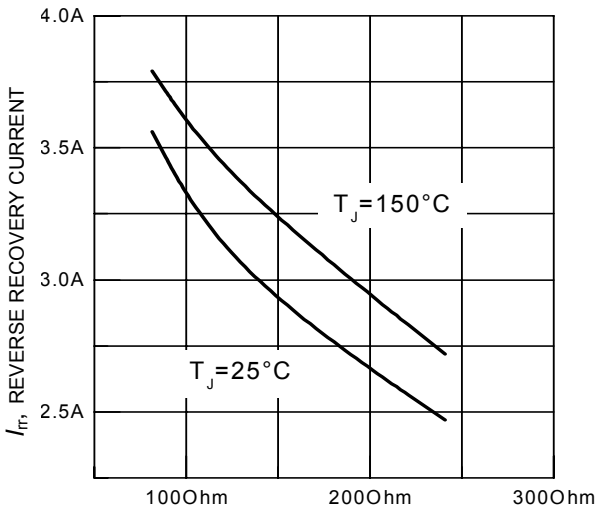
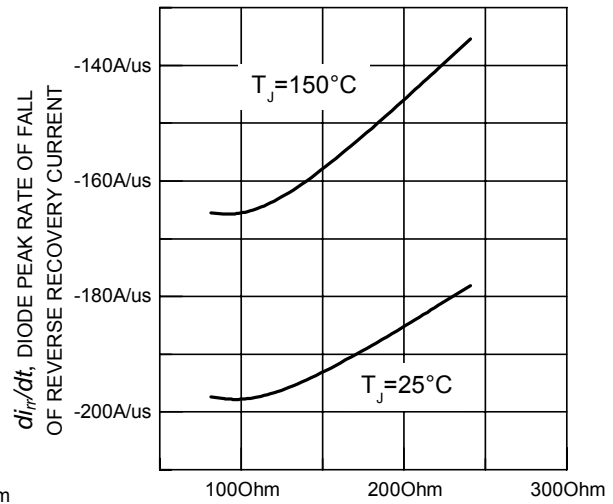

Figure 24. Typical reverse recovery charge as a function of diode current slope
 ($V_R=800V$, $I_F=3A$,
 Dynamic test circuit in Figure E)



R_G , GATE RESISTANCE

Figure 25. Typical reverse recovery current as a function of diode current slope
 ($V_R=800\text{V}$, $I_F=3\text{A}$,
 Dynamic test circuit in Figure E)



R_G , GATE RESISTANCE

Figure 26. Typical diode peak rate of fall of reverse recovery current as a function of diode current slope
 ($V_R=800\text{V}$, $I_F=3\text{A}$,
 Dynamic test circuit in Figure E)

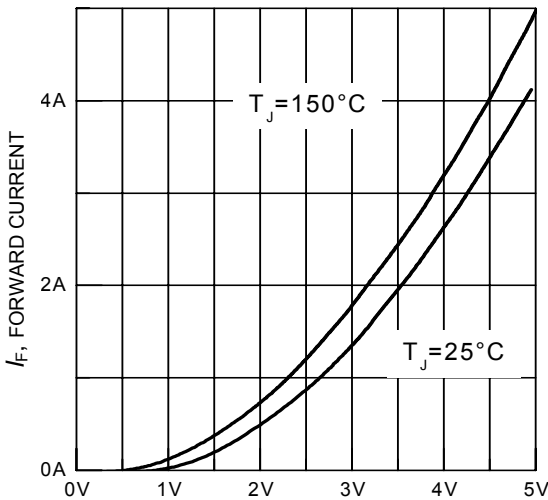

V_F , FORWARD VOLTAGE

Figure 27. Typical diode forward current as a function of forward voltage

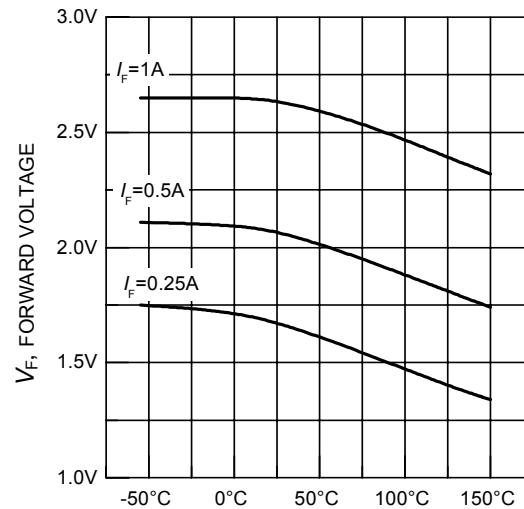

T_J , JUNCTION TEMPERATURE

Figure 28. Typical diode forward voltage as a function of junction temperature

TO-220AB

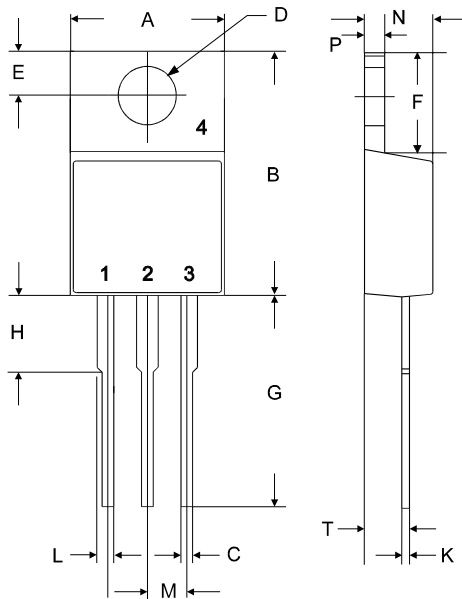

symbol	dimensions			
	[mm]		[inch]	
	min	max	min	max
A	9.70	10.30	0.3819	0.4055
B	14.88	15.95	0.5858	0.6280
C	0.65	0.86	0.0256	0.0339
D	3.55	3.89	0.1398	0.1531
E	2.60	3.00	0.1024	0.1181
F	6.00	6.80	0.2362	0.2677
G	13.00	14.00	0.5118	0.5512
H	4.35	4.75	0.1713	0.1870
K	0.38	0.65	0.0150	0.0256
L	0.95	1.32	0.0374	0.0520
M	2.54 typ.		0.1 typ.	
N	4.30	4.50	0.1693	0.1772
P	1.17	1.40	0.0461	0.0551
T	2.30	2.72	0.0906	0.1071

TO-263AB (D²Pak)

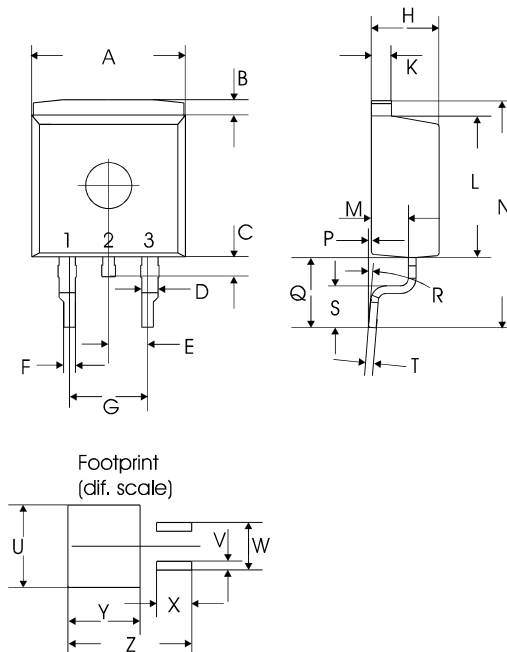

symbol	dimensions			
	[mm]		[inch]	
	min	max	min	max
A	9.80	10.20	0.3858	0.4016
B	0.70	1.30	0.0276	0.0512
C	1.00	1.60	0.0394	0.0630
D	1.03	1.07	0.0406	0.0421
E	2.54 typ.		0.1 typ.	
F	0.65	0.85	0.0256	0.0335
G	5.08 typ.		0.2 typ.	
H	4.30	4.50	0.1693	0.1772
K	1.17	1.37	0.0461	0.0539
L	9.05	9.45	0.3563	0.3720
M	2.30	2.50	0.0906	0.0984
N	15 typ.		0.5906 typ.	
P	0.00	0.20	0.0000	0.0079
Q	4.20	5.20	0.1654	0.2047
R	8° max		8° max	
S	2.40	3.00	0.0945	0.1181
T	0.40	0.60	0.0157	0.0236
U	10.80		0.4252	
V	1.15		0.0453	
W	6.23		0.2453	
X	4.60		0.1811	
Y	9.40		0.3701	
Z	16.15		0.6358	

TO-252AA (DPak)

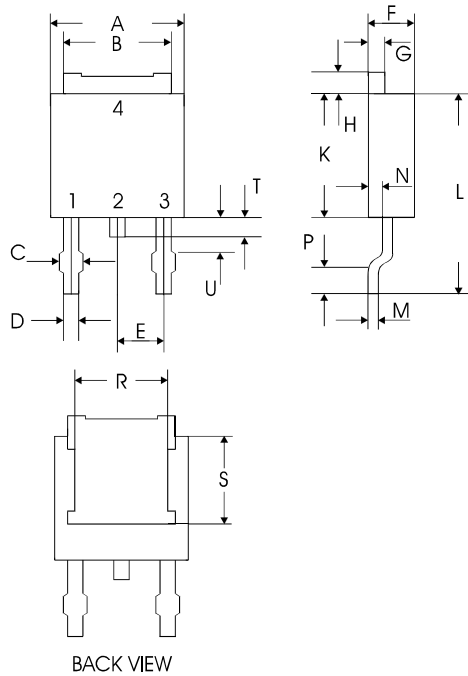

symbol	dimensions			
	[mm]		symbol	
	min		min	
A	6.40	A	6.40	A
B	5.25	B	5.25	B
C	(0.65)	C	(0.65)	C
D	0.63	D	0.63	D
E	2.28		E	
F	2.19	F	2.19	F
G	0.76	G	0.76	G
H	0.90	H	0.90	H
K	5.97	K	5.97	K
L	9.40	L	9.40	L
M	0.46	M	0.46	M
N	0.87	N	0.87	N
P	0.51	P	0.51	P
R	5.00	R	5.00	R
S	4.17	S	4.17	S
T	0.26	T	0.26	T
U	-	U	-	U

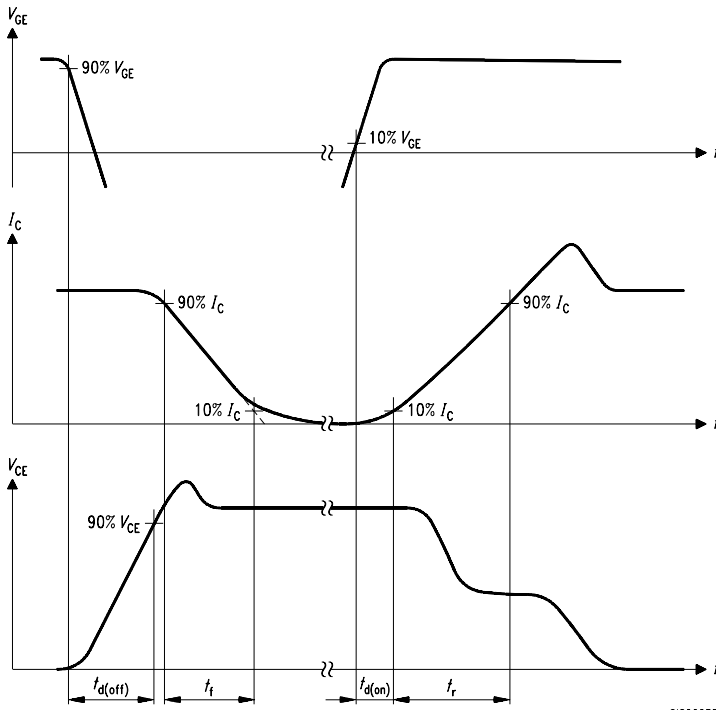
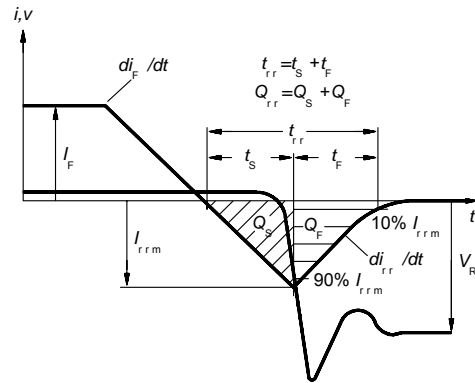
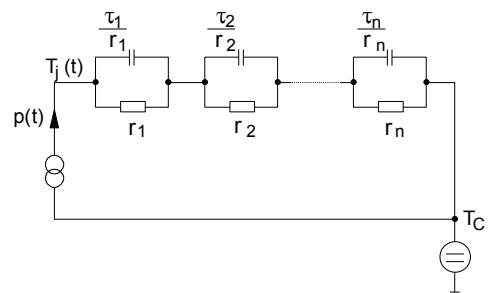
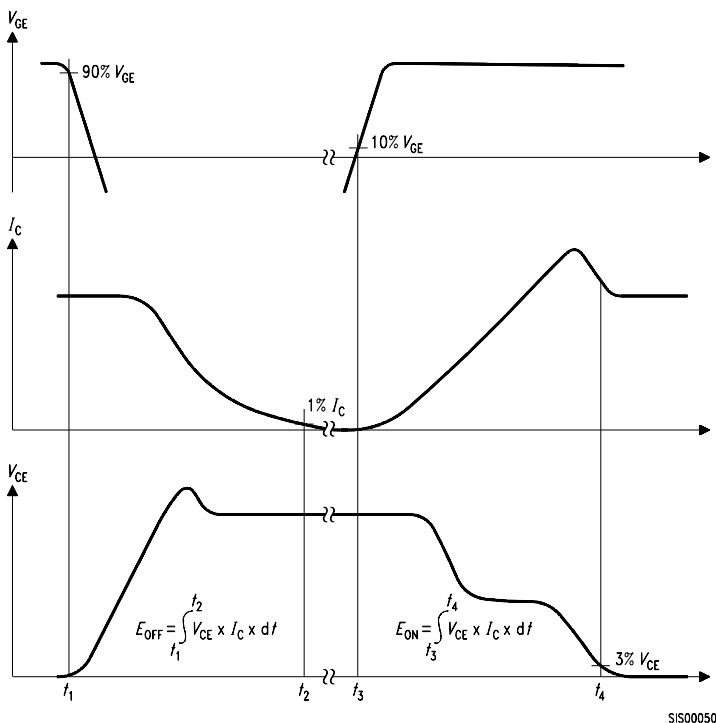
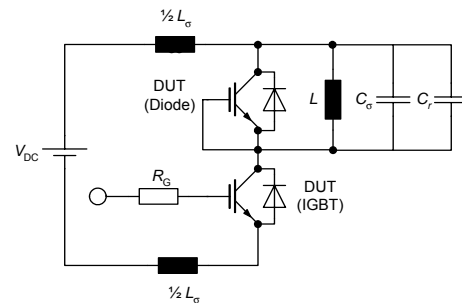
Figure A. Definition of switching times

Figure C. Definition of diodes switching characteristics

Figure D. Thermal equivalent circuit

Figure B. Definition of switching losses

Figure E. Dynamic test circuit
 Leakage inductance $L_\sigma = 180\text{nH}$,
 Stray capacitor $C_\sigma = 40\text{pF}$,
 Relief capacitor $C_r = 1\text{nF}$ (only for ZVT switching)

Published by
Infineon Technologies AG i Gr.,
Bereich Kommunikation
St.-Martin-Strasse 53,
D-81541 München
© Infineon Technologies AG 1999
All Rights Reserved.

Attention please!

The information herein is given to describe certain components and shall not be considered as warranted characteristics.

Terms of delivery and rights to technical change reserved.

We hereby disclaim any and all warranties, including but not limited to warranties of non-infringement, regarding circuits, descriptions and charts stated herein.

Infineon Technologies is an approved CECC manufacturer.

Information

For further information on technology, delivery terms and conditions and prices please contact your nearest Infineon Technologies Office in Germany or our Infineon Technologies Representatives worldwide (see address list).

Warnings

Due to technical requirements components may contain dangerous substances. For information on the types in question please contact your nearest Infineon Technologies Office.

Infineon Technologies Components may only be used in life-support devices or systems with the express written approval of Infineon Technologies, if a failure of such components can reasonably be expected to cause the failure of that life-support device or system, or to affect the safety or effectiveness of that device or system. Life support devices or systems are intended to be implanted in the human body, or to support and/or maintain and sustain and/or protect human life. If they fail, it is reasonable to assume that the health of the user or other persons may be endangered.