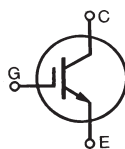


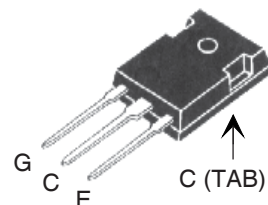
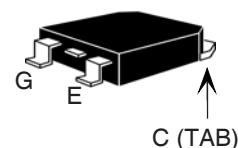
**GenX3™ 600V IGBT**
**IXGH64N60A3  
IXGT64N60A3**
**Ultra-lowV<sub>sat</sub> PT IGBTs for up to  
5 kHz switching**


$$V_{CES} = 600V$$

$$I_{C110} = 64A$$

$$V_{CE(sat)} \leq 1.35V$$

Symbol	Test Conditions	Maximum Ratings	
$V_{CES}$	$T_C = 25^\circ C$ to $150^\circ C$	600	V
$V_{CGR}$	$T_J = 25^\circ C$ to $150^\circ C$ , $R_{GE} = 1M\Omega$	600	V
$V_{GES}$	Continuous	$\pm 20$	V
$V_{GEM}$	Transient	$\pm 30$	V
$I_{C110}$	$T_C = 110^\circ C$	64	A
$I_{CM}$	$T_C = 25^\circ C$ , 1ms	400	A
<b>SSOA</b>	$V_{GE} = 15V$ , $T_{VJ} = 125^\circ C$ , $R_G = 3\Omega$	$I_{CM} = 100$	A
<b>(RBSOA)</b>	Clamped inductive load @ $\leq 600V$		
$P_C$	$T_C = 25^\circ C$	460	W
$T_J$		-55 ... +150	$^\circ C$
$T_{JM}$		150	$^\circ C$
$T_{stg}$		-55 ... +150	$^\circ C$
$T_L$	1.6mm (0.062 in.) from case for 10s	300	$^\circ C$
$T_{SOLD}$	Plastic body for 10 seconds	260	$^\circ C$
$M_d$	Mounting torque (TO-247)	1.13/10	Nm/lb.in.
<b>Weight</b>	TO-247	6	g
	TO-268	5	g

**TO-247 (IXGH)**

**TO-268 (IXGT)**


G = Gate      C = Collector  
E = Emitter    TAB = Collector

**Features**

- Optimized for low conduction losses
- Square RBSOA
- International standard packages

**Advantages**

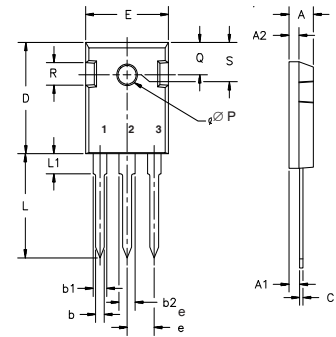
- High power density
- Low gate drive requirement

**Applications**

- Power Inverters
- UPS
- Motor Drives
- SMPS
- PFC Circuits
- Battery Chargers
- Welding Machines
- Lamp Ballasts
- Inrush Current Protection Circuits

Symbol	Test Conditions	Characteristic Values		
		Min.	Typ.	Max.
$BV_{CES}$	$I_C = 250\mu A$ , $V_{GE} = 0V$	600		V
$V_{GE(th)}$	$I_C = 250\mu A$ , $V_{CE} = V_{GE}$	3.0		5.0 V
$I_{CES}$	$V_{CE} = V_{CES}$			50 $\mu A$
	$V_{GE} = 0V$		$T_J = 125^\circ C$	500 $\mu A$
$I_{GES}$	$V_{CE} = 0V$ , $V_{GE} = \pm 20V$			$\pm 100$ nA
$V_{CE(sat)}$	$I_C = 50A$ , $V_{GE} = 15V$ , Note 1	1.20	1.35	V

Symbol	Test Conditions	Characteristic Values		
		Min.	Typ.	Max.
$g_{fS}$	$I_C = 50A, V_{CE} = 10V$ , Note 1	40	70	S
$C_{ies}$	$V_{CE} = 25V, V_{GE} = 0V, f = 1MHz$		4850	pF
$C_{oes}$			270	pF
$C_{res}$			66	pF
$Q_g$	$I_C = 50A, V_{GE} = 15V, V_{CE} = 0.5 \cdot V_{CES}$		167	nC
$Q_{ge}$			28	nC
$Q_{gc}$			60	nC
$t_{d(on)}$	<b>Inductive load, <math>T_J = 25^\circ C</math></b> $I_C = 50A, V_{GE} = 15V$ $V_{CE} = 480V, R_G = 3\Omega$		26	ns
$t_{ri}$			40	ns
$E_{on}$			1.42	mJ
$t_{d(off)}$			268	ns
$t_{fi}$			222	ns
$E_{off}$		3.28	mJ	
$t_{d(on)}$	<b>Inductive load, <math>T_J = 125^\circ C</math></b> $I_C = 50A, V_{GE} = 15V$ $V_{CE} = 480V, R_G = 3\Omega$		25	ns
$t_{ri}$			40	ns
$E_{on}$			2.76	mJ
$t_{d(off)}$			415	ns
$t_{fi}$			362	ns
$E_{off}$		6.00	mJ	
$R_{thJC}$			0.27	$^\circ C/W$
$R_{thCS}$		0.25		$^\circ C/W$

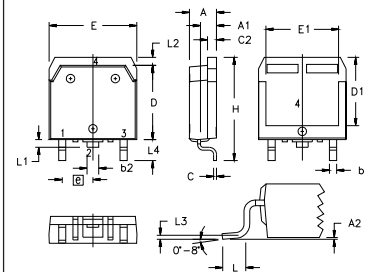
**TO-247 (IXGH) Outline**

 Terminals: 1 - Gate  
 2 - Drain  
 3 - Source  
 Tab - Drain

Dim.	Millimeter		Inches	
	Min.	Max.	Min.	Max.
A	4.7	5.3	.185	.209
A <sub>1</sub>	2.2	2.54	.087	.102
A <sub>2</sub>	2.2	2.6	.059	.098
b	1.0	1.4	.040	.055
b <sub>1</sub>	1.65	2.13	.065	.084
b <sub>2</sub>	2.87	3.12	.113	.123
C	.4	.8	.016	.031
D	20.80	21.46	.819	.845
E	15.75	16.26	.610	.640
e	5.20	5.72	0.205	0.225
L	19.81	20.32	.780	.800
L <sub>1</sub>		4.50		.177
∅P	3.55	3.65	.140	.144
Q	5.89	6.40	0.232	0.252
R	4.32	5.49	.170	.216
S	6.15	BSC	242	BSC

 Note 1: Pulse test,  $t \leq 300\mu s$ , duty cycle,  $d \leq 2\%$ .

**PRELIMINARY TECHNICAL INFORMATION**

The product presented herein is under development. The Technical Specifications offered are derived from data gathered during objective characterizations of preliminary engineering lots; but also may yet contain some information supplied during a pre-production design evaluation. IXYS reserves the right to change limits, test conditions, and dimensions without notice.

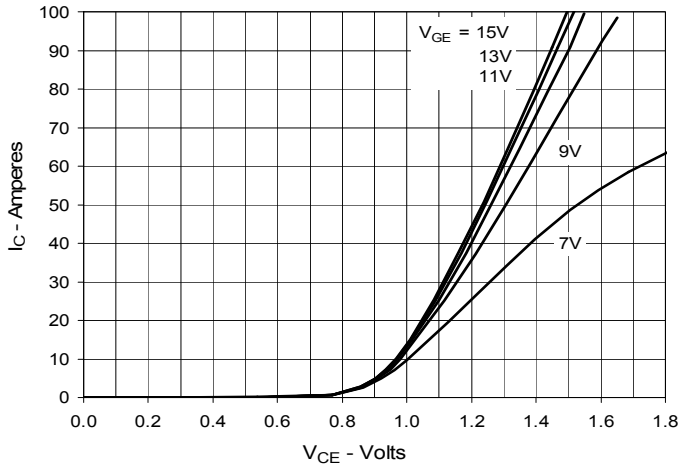
**TO-268 (IXGT) Outline**


SYM	INCHES		MILLIMETERS	
	MIN	MAX	MIN	MAX
A	.193	.201	4.90	5.10
A1	.106	.114	2.70	2.90
A2	.001	.010	0.02	0.25
b	.045	.057	1.15	1.45
b2	.075	.083	1.90	2.10
C	.016	.026	0.40	0.65
C2	.057	.063	1.45	1.60
D	.543	.551	13.80	14.00
D1	.488	.500	12.40	12.70
E	.624	.632	15.85	16.05
E1	.524	.535	13.30	13.60
e		.215 BSC		5.45 BSC
H	.736	.752	18.70	19.10
L	.094	.106	2.40	2.70
L1	.047	.055	1.20	1.40
L2	.039	.045	1.00	1.15
L3		.010 BSC		0.25 BSC
L4	.150	.161	3.80	4.10

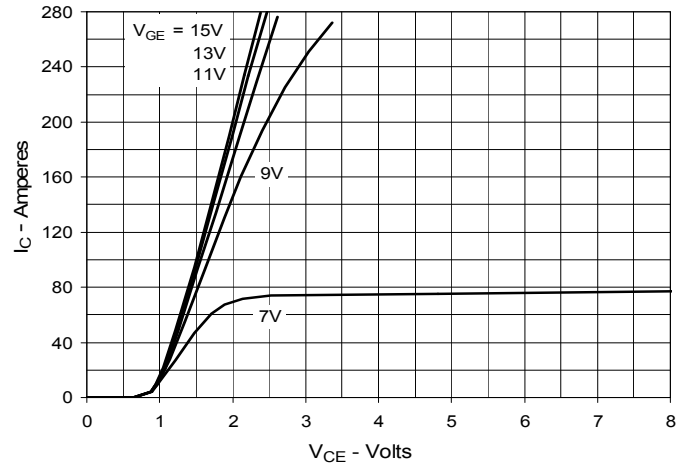
IXYS reserves the right to change limits, test conditions and dimensions.

IXYS MOSFETs and IGBTs are covered by one or more of the following U.S. patents:	4,835,592	4,931,844	5,049,961	5,237,481	6,162,665	6,404,065 B1	6,683,344	6,727,585	7,005,734 B2	7,157,338B2
	4,850,072	5,017,508	5,063,307	5,381,025	6,259,123 B1	6,534,343	6,710,405 B2	6,759,692	7,063,975 B2	
	4,881,106	5,034,796	5,187,117	5,486,715	6,306,728 B1	6,583,505	6,710,463	6,771,478 B2	7,071,537	

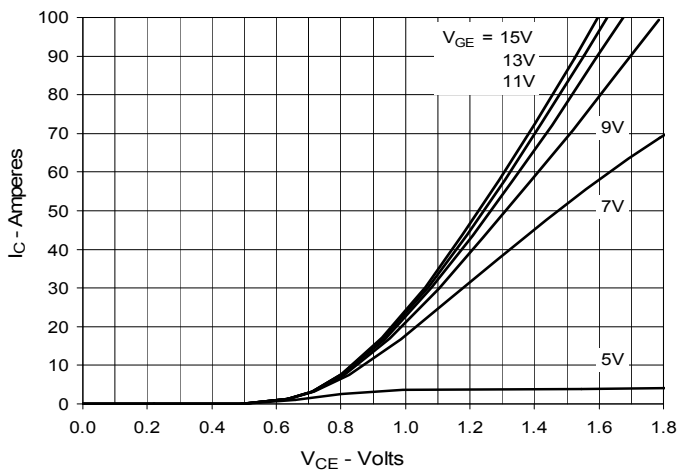
**Fig. 1. Output Characteristics @ 25°C**



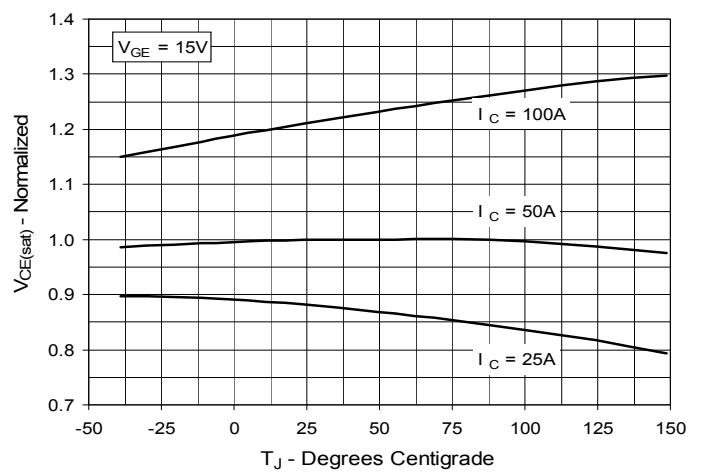
**Fig. 2. Extended Output Characteristics @ 25°C**



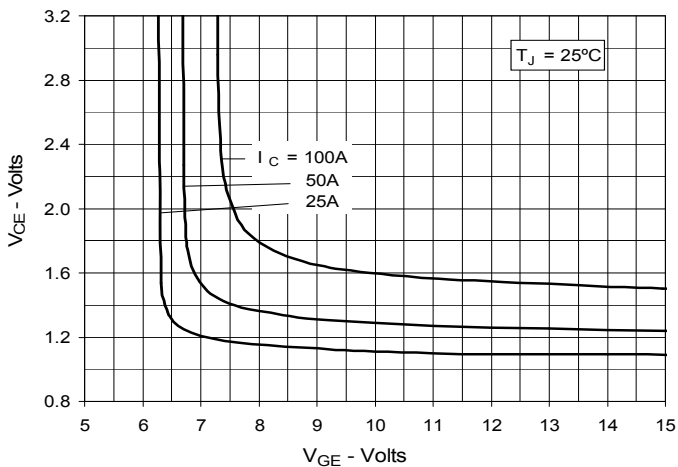
**Fig. 3. Output Characteristics @ 125°C**



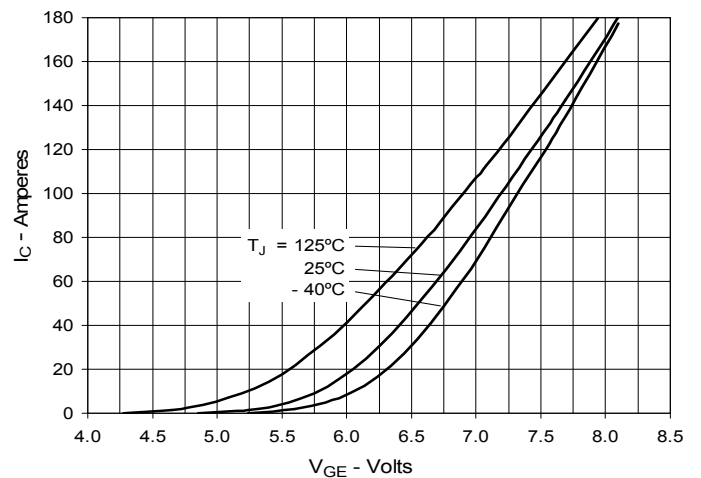
**Fig. 4. Dependence of  $V_{CE(sat)}$  on Junction Temperature**



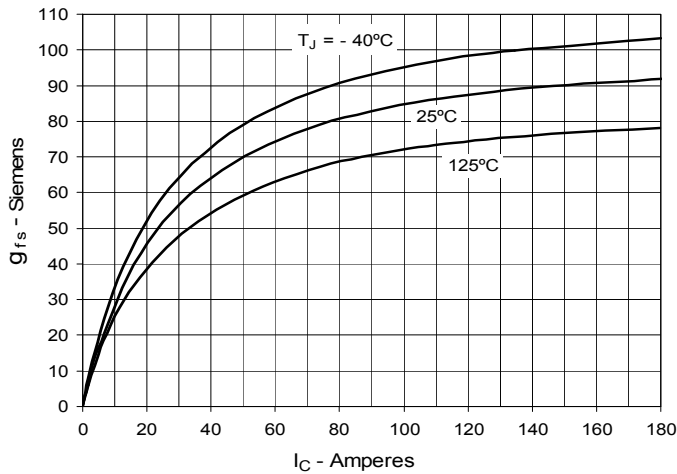
**Fig. 5. Collector-to-Emitter Voltage vs. Gate-to-Emitter Voltage**



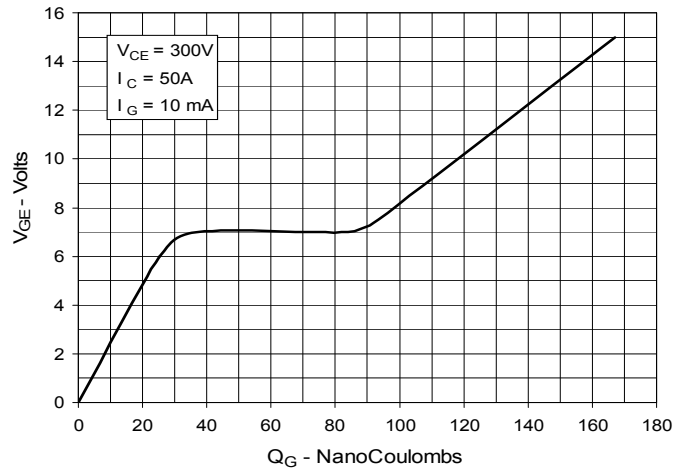
**Fig. 6. Input Admittance**



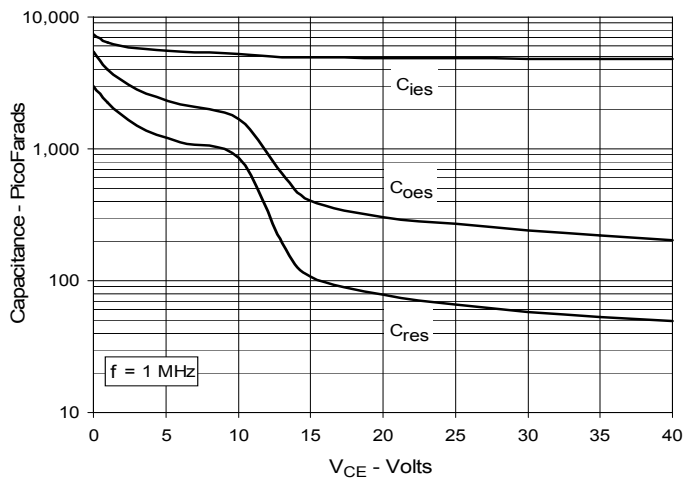
**Fig. 7. Transconductance**



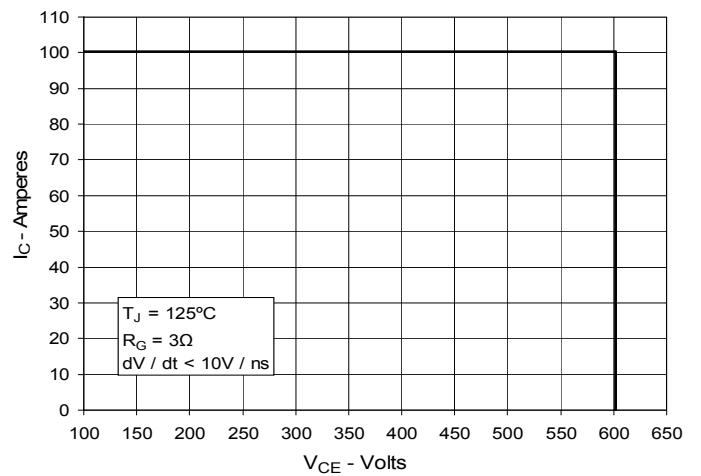
**Fig. 8. Gate Charge**



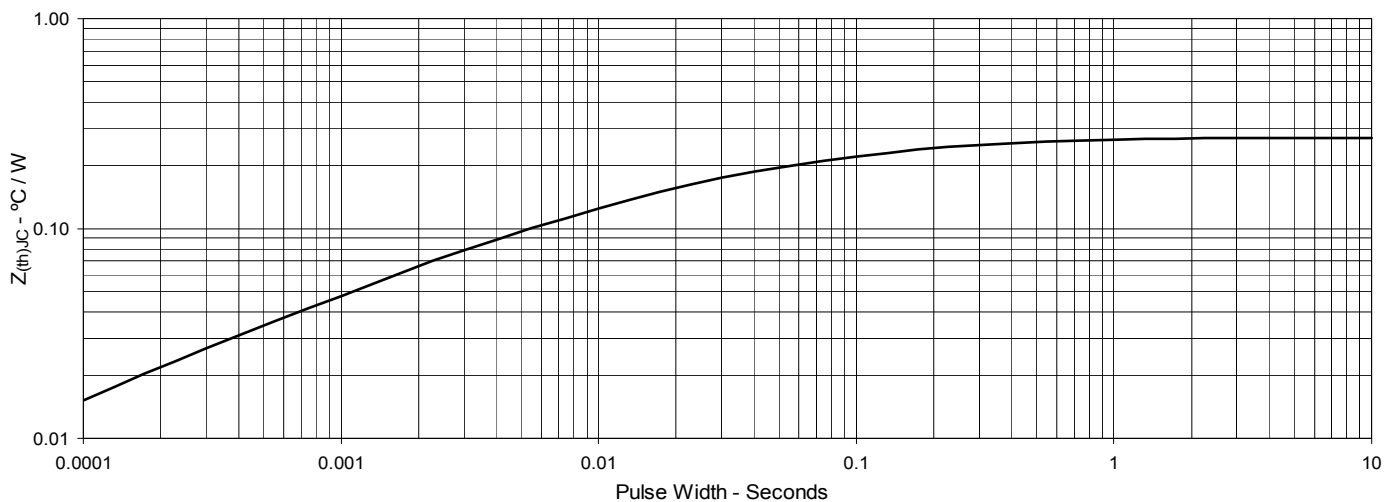
**Fig. 9. Capacitance**



**Fig. 10. Reverse-Bias Safe Operating Area**

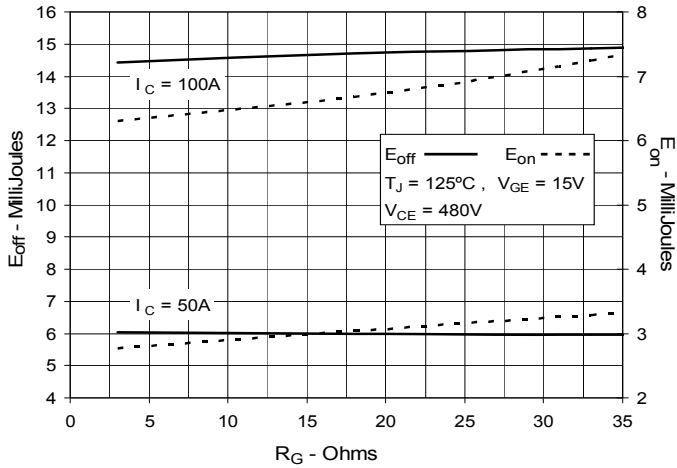


**Fig. 11. Maximum Transient Thermal Impedance**

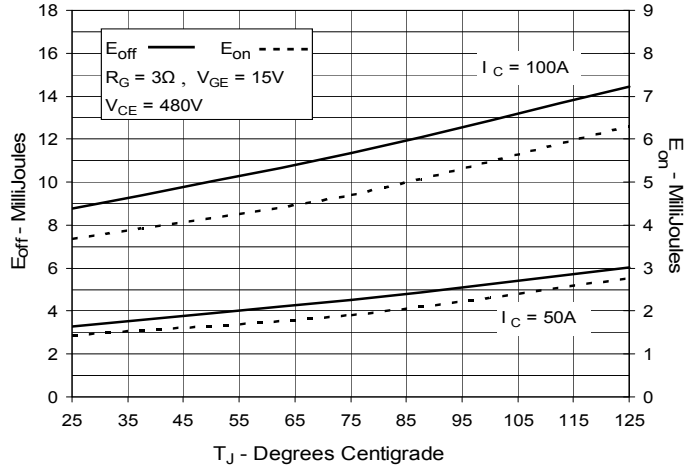


IXYS reserves the right to change limits, test conditions and dimensions.

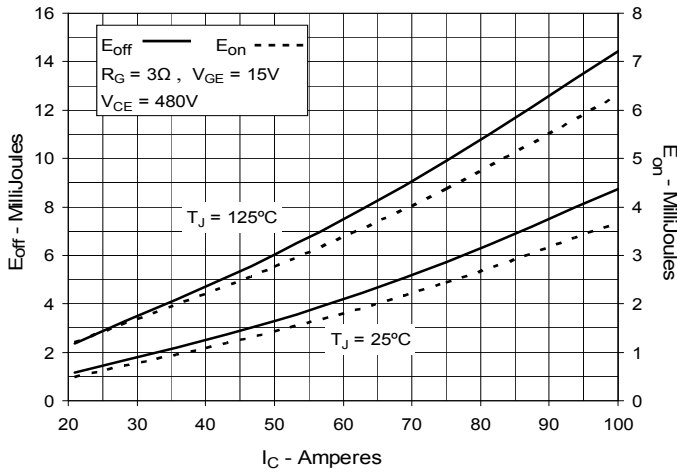
**Fig. 12. Inductive Switching Energy Loss vs. Gate Resistance**



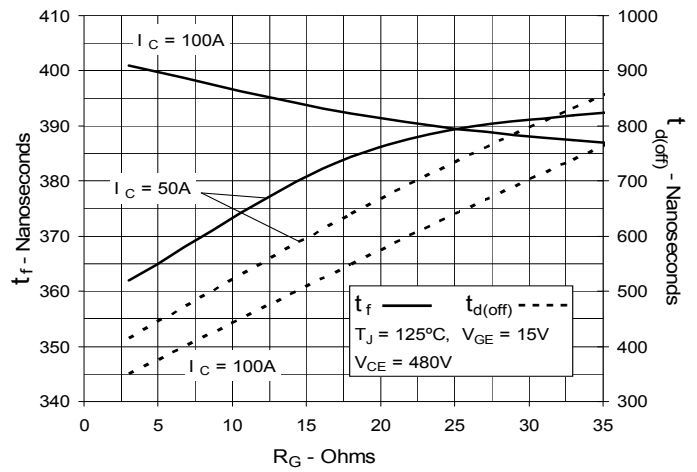
**Fig. 13. Inductive Switching Energy Loss vs. Junction Temperature**



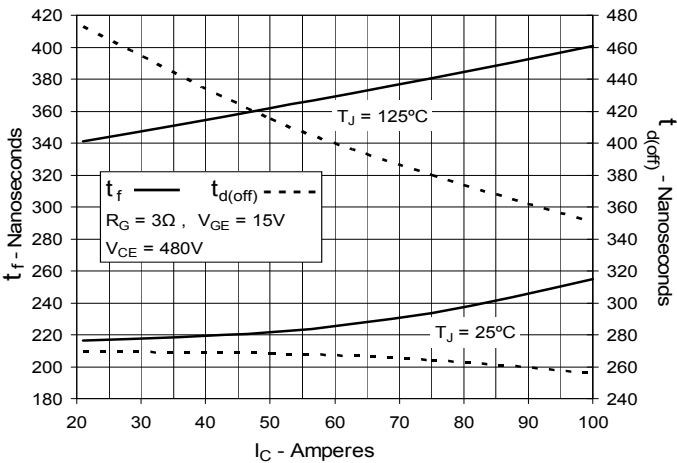
**Fig. 14. Inductive Switching Energy Loss vs. Collector Current**



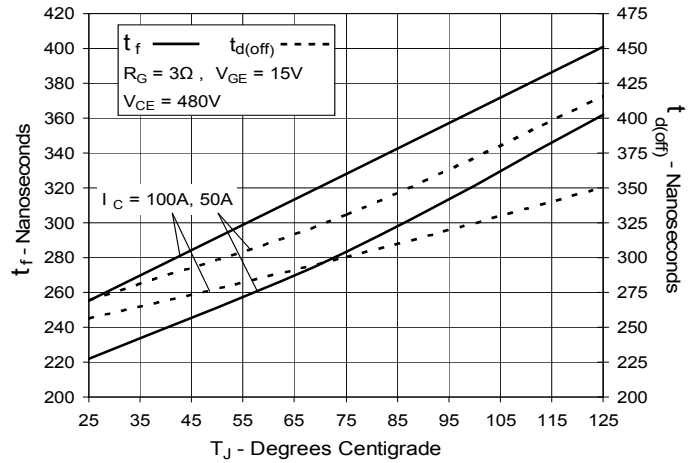
**Fig. 15. Inductive Turn-off Switching Times vs. Gate Resistance**



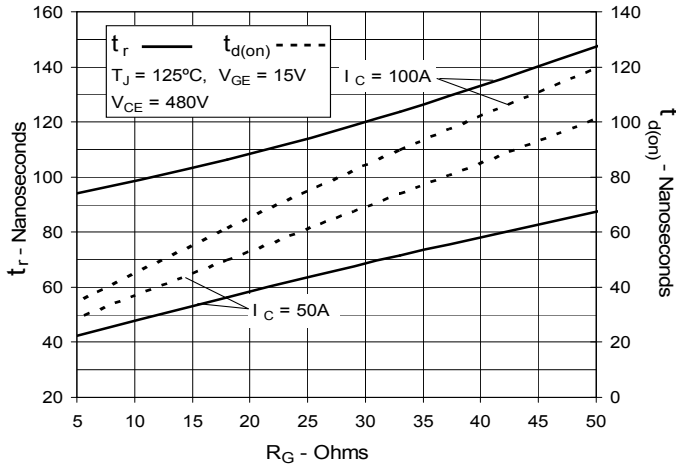
**Fig. 16. Inductive Turn-off Switching Times vs. Collector Current**



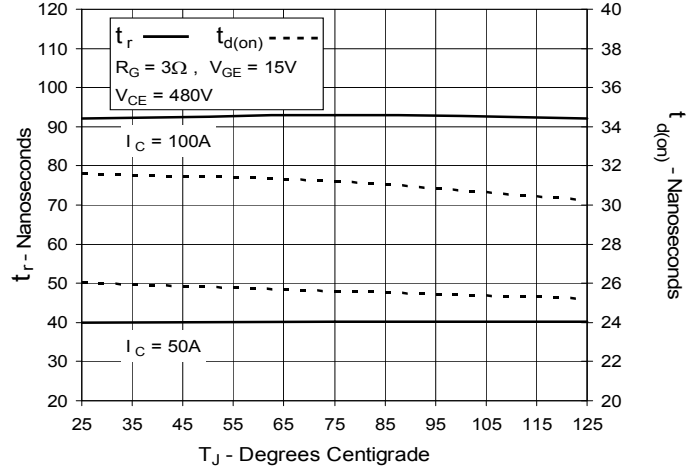
**Fig. 17. Inductive Turn-off Switching Times vs. Junction Temperature**



**Fig. 18. Inductive Turn-on  
Switching Times vs. Gate Resistance**



**Fig. 19. Inductive Turn-on  
Switching Times vs. Junction Temperature**



**Fig. 20. Inductive Turn-on  
Switching Times vs. Collector Current**

