

Silicon PNP Power Transistors

2SA1209

DESCRIPTION

- With TO-126 package
- Complement to type 2SC2911
- High breakdown voltage
- Fast switching speed

APPLICATIONS

- High-voltage switching and AF 100W predriver applications

PINNING

PIN	DESCRIPTION
1	Emitter
2	Collector;connected to mounting base
3	Base

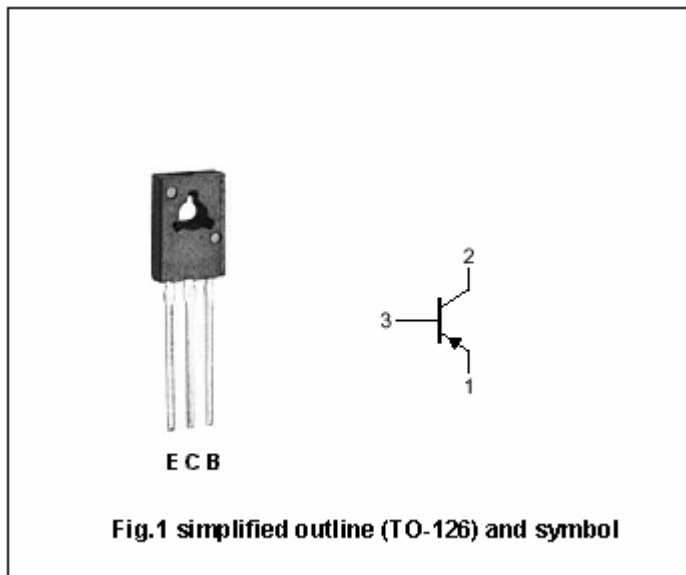

Absolute maximum ratings(Ta=25°C)

SYMBOL	PARAMETER	CONDITIONS	VALUE	UNIT
V _{CBO}	Collector-base voltage	Open emitter	-180	V
V _{CEO}	Collector-emitter voltage	Open base	-160	V
V _{EBO}	Emitter-base voltage	Open collector	-5	V
I _C	Collector current		-0.14	A
I _{CM}	Collector current-Peak		-0.20	A
P _C	Collector power dissipation	T _a =25°C	1.0	W
		T _C =25°C	10	
T _j	Junction temperature		150	°C
T _{stg}	Storage temperature		-55~150	°C

Silicon PNP Power Transistors

2SA1209

CHARACTERISTICS

T_j=25°C unless otherwise specified

SYMBOL	PARAMETER	CONDITIONS	MIN	TYP.	MAX	UNIT
V _{CEsat}	Collector-emitter saturation voltage	I _C =-50mA; I _B =-5mA			-0.4	V
I _{CB0}	Collector cut-off current	V _{CB} =-80V; I _E =0			-0.1	μA
I _{EBO}	Emitter cut-off current	V _{EB} =-4V; I _C =0			-0.1	μA
h _{FE}	DC current gain	I _C =-10mA; V _{CE} =-5V	100		400	
f _T	Transition frequency	I _C =-10mA; V _{CE} =-10V		150		MHz
C _{ob}	Output capacitance	I _E =0; V _{CB} =-10V; f=1MHz		4.0		pF

Switching times resistive load

t _{on}	Turn-on time	I _C =10mA I _{B1} =-I _{B2} =1mA		0.1		μs
t _s	Storage time			1.5		μs
t _f	Fall time			0.1		μs

◆ h_{FE} Classifications

R	S	T
100-200	140-280	200-400

Silicon PNP Power Transistors

2SA1209

PACKAGE OUTLINE

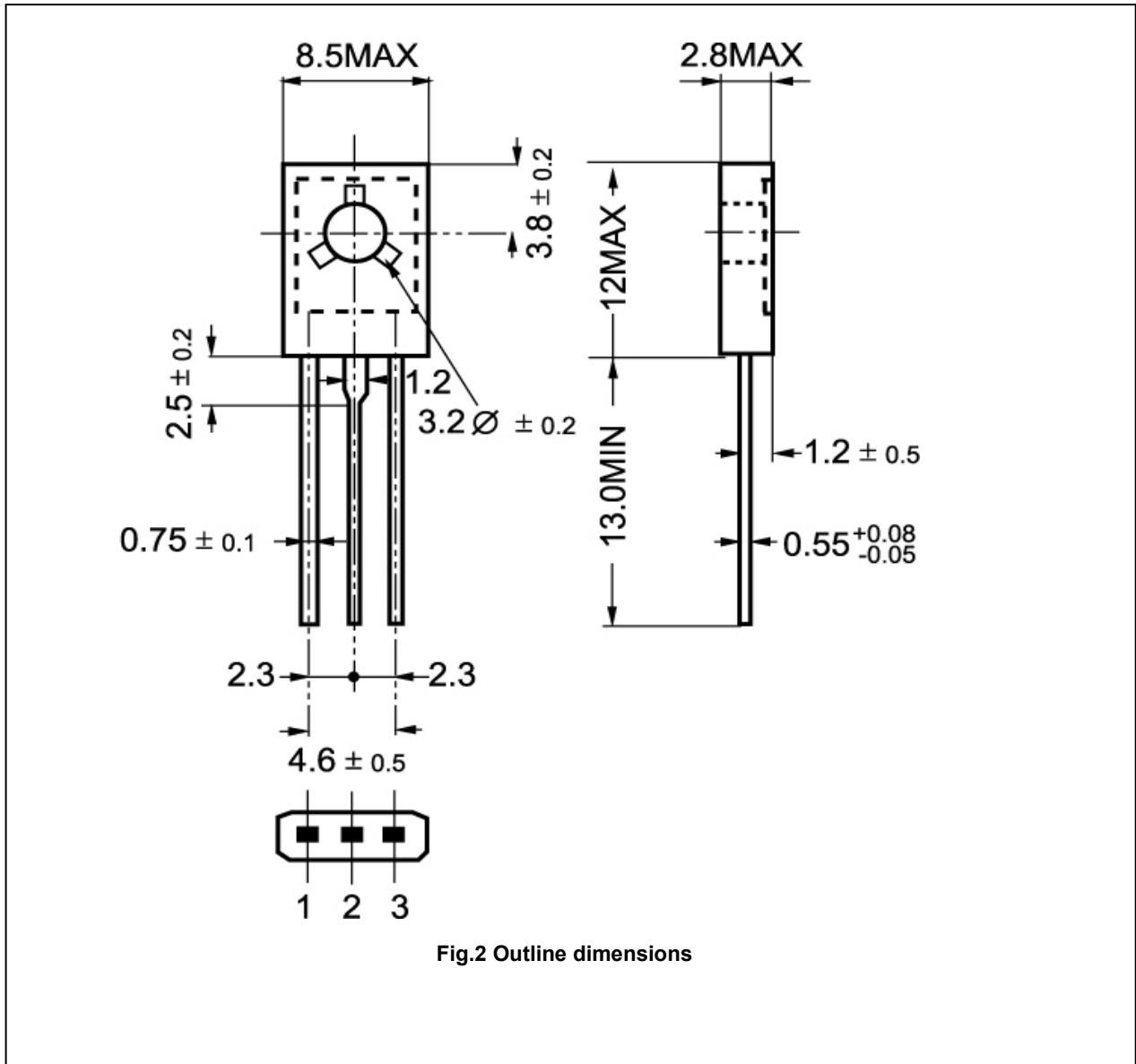

Silicon PNP Power Transistors

2SA1209

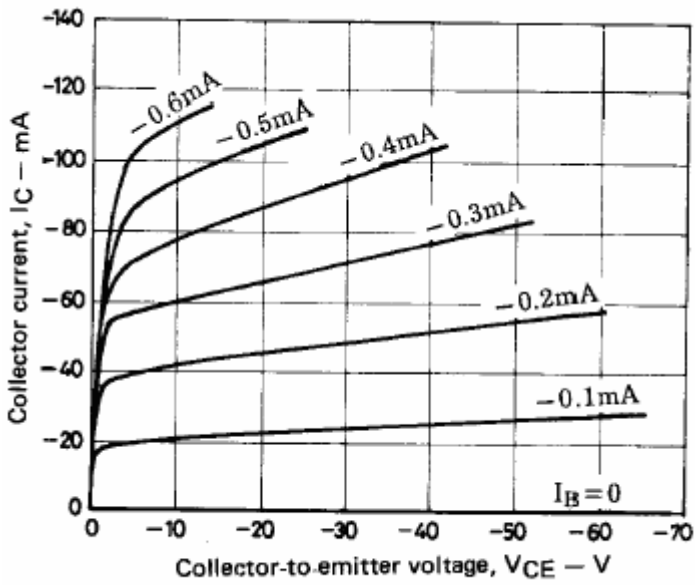

Fig.3 Static Characteristic

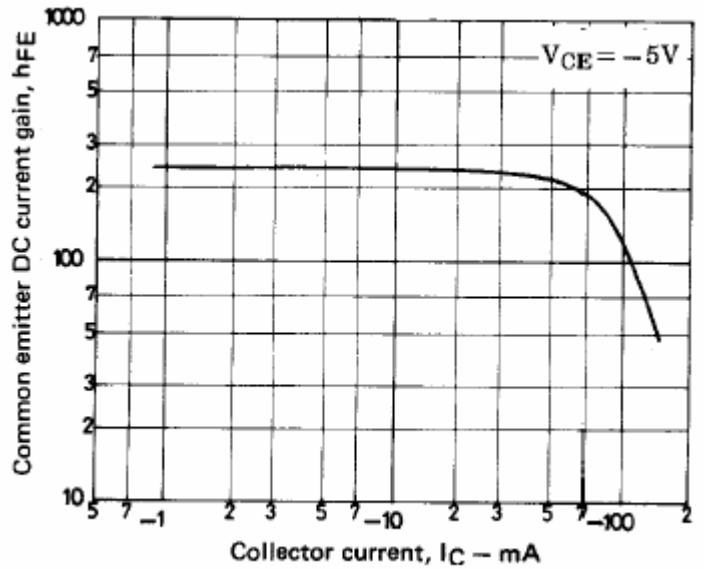

Fig.4 DC current Gain

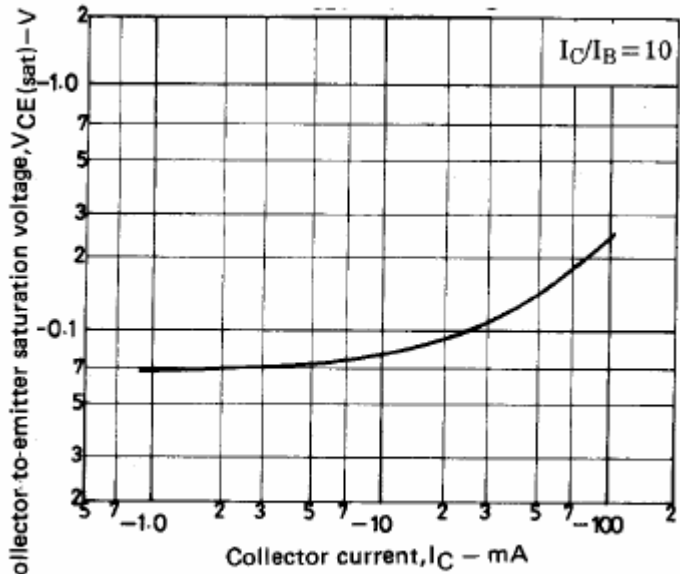

Fig.5 Collector-Emitter Saturation Voltage

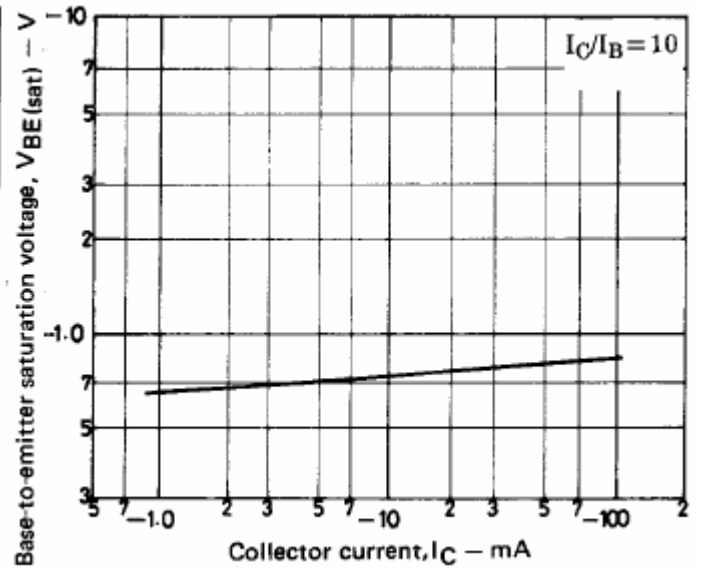

Fig.6 Base-Emitter Saturation Voltage

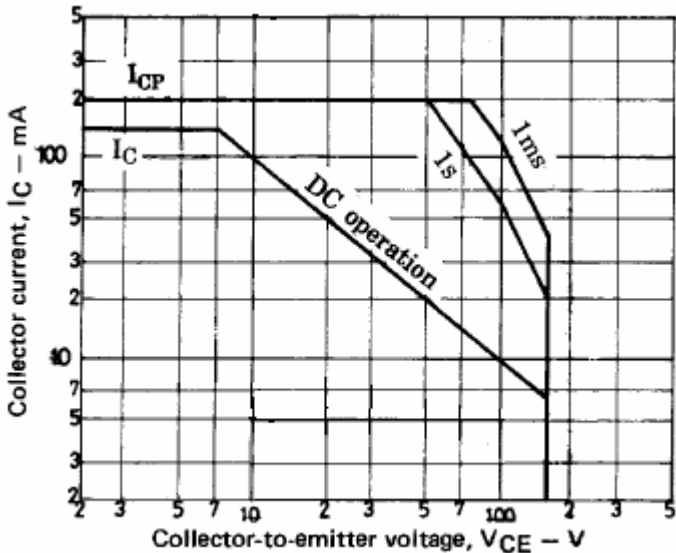

Fig.7 Safe Operating Area