

PLEASE CHECK WWW.MOLEX.COM FOR LATEST PART INFORMATION

Part Number: [0015045444](#)
Status: **Active**
Overview: [cgrid_sl_products](#)
Description: 2.54mm (.100") SL™ Interim Clip, 44 Circuits, Polarized

Documents:

[3D Model](#) [Drawing \(PDF\)](#)
[Packaging Specification \(PDF\)](#) [RoHS Certificate of Compliance \(PDF\)](#)

Agency Certification

CSA LR19980
 UL E29179

General

Product Family Accessories
 Series [70013](#)
 Component Type Clip
 Overview [cgrid_sl_products](#)
 Product Name SL™

Physical

Circuits (Loaded) 44
 Color - Resin Black
 Flammability 94V-0
 Lock to Mating Part Yes
 Material - Resin Polyester
 Number of Rows 2
 Packaging Type Bag
 Polarized to Mating Part Yes

Material Info

Old Part Number 70013-1044

Reference - Drawing Numbers

Sales Drawing SD-70013-0001-1050

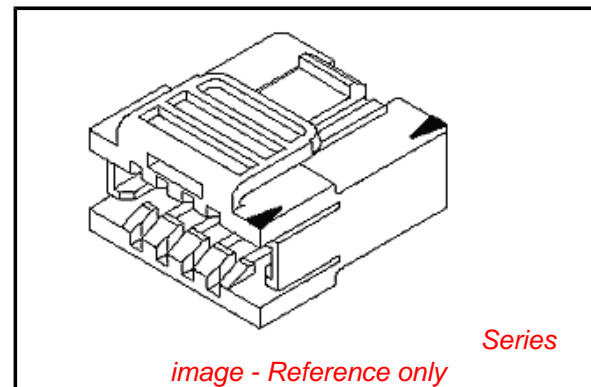

EU RoHS

**ELV and RoHS
 Compliant**
**REACH SVHC
 Contains SVHC: No**
**Halogen-Free
 Status
 Not Reviewed**

China RoHS



**Need more information on product
 environmental compliance?**

Email productcompliance@molex.com
 For a multiple part number RoHS Certificate of
 Compliance, [click here](#)

Please visit the [Contact Us](#) section for any
 non-product compliance questions.

Search Parts in this Series

[70013Series](#)

Use With

[70066](#) SL™ Crimp Housing. [70058](#) SL™
 Crimp Terminal. [70400](#) C-Grid SL™ IDT
 Connector Assembly. [70430](#) C-Grid SL™.
[70450](#) SL™ Crimp Housing

CKT. SIZE	OPTION A (WITHOUT RIBS)		OPTION B (WITH RIBS)		DIMENSION	
	EDP. NO.	ENG. NO.	EDP. NO.	ENG. NO.	A	B
	4	NOT TOOLED	X-70013-0008	NOT TOOLED	X-70013-1004	(5.33) .210
6	015-04-5061	70013-0001	015-04-5064	70013-1006	(7.87) .310	(5.08) .200
8	015-04-5081	70013-0007	015-04-5084	70013-1008	(10.41) .410	(7.62) .300
10	015-04-5101	70013-0002	015-04-5104	70013-1010	(12.95) .510	(10.16) .400
12	015-04-5121	70013-0012	015-04-5124	70013-1012	(15.49) .610	(12.70) .500
14	015-04-5141	70013-0014	015-04-5144	70013-1014	(18.03) .710	(15.24) .600
16	015-04-5161	70013-0016	015-04-5164	70013-1016	(20.57) .810	(17.78) .700
18	015-04-5181	70013-0018	015-04-5184	70013-1018	(23.11) .910	(20.32) .800
20	015-04-5201	70013-0003	015-04-5204	70013-1020	(25.65) 1.010	(22.86) .900
22	015-04-5221	70013-0022	015-04-5224	70013-1022	(28.19) 1.110	(25.40) 1.000
24	015-04-5241	70013-0024	015-04-5244	70013-1024	(30.73) 1.210	(27.94) 1.100
26	015-04-5261	70013-0026	015-04-5264	70013-1026	(33.27) 1.310	(30.48) 1.200
28	015-04-5281	70013-0028	015-04-5284	70013-1028	(35.81) 1.410	(33.02) 1.300
30	015-04-5301	70013-0004	015-04-5304	70013-1030	(38.35) 1.510	(35.56) 1.400
32	015-04-5321	70013-0032	015-04-5324	70013-1032	(40.89) 1.610	(38.10) 1.500
34	015-04-5341	70013-0034	015-04-5344	70013-1034	(43.43) 1.710	(40.64) 1.600
36	015-04-5361	70013-0036	015-04-5364	70013-1036	(45.97) 1.810	(43.18) 1.700
38	015-04-5381	70013-0038	015-04-5384	70013-1038	(48.51) 1.910	(45.72) 1.800
40	015-04-5401	70013-0005	015-04-5404	70013-1040	(51.05) 2.010	(48.26) 1.900
42	015-04-5421	70013-0042	015-04-5424	70013-1042	(53.59) 2.110	(50.80) 2.000
44	015-04-5441	70013-0044	015-04-5444	70013-1044	(56.13) 2.210	(53.34) 2.100
46	015-04-5461	70013-0046	015-04-5464	70013-1046	(58.67) 2.310	(55.88) 2.200
48	015-04-5481	70013-0048	015-04-5484	70013-1048	(61.21) 2.410	(58.42) 2.300
50	015-04-5501	70013-0006	015-04-5504	70013-1050	(63.75) 2.510	(60.96) 2.400

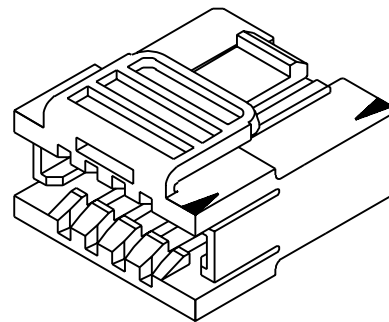
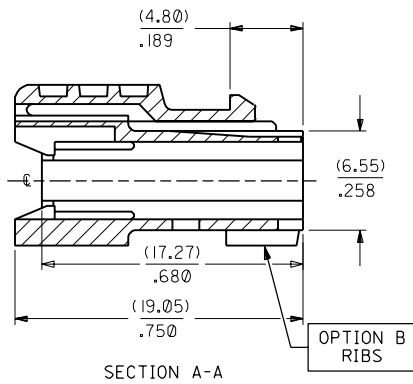
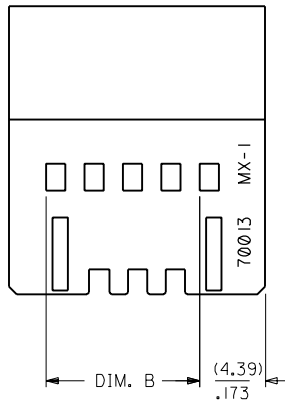
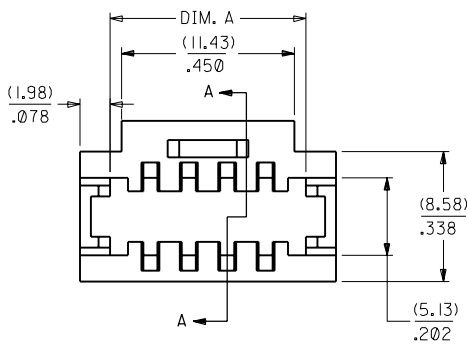
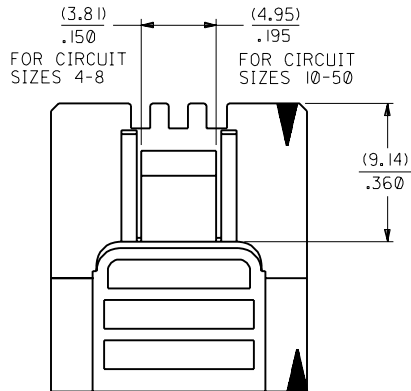
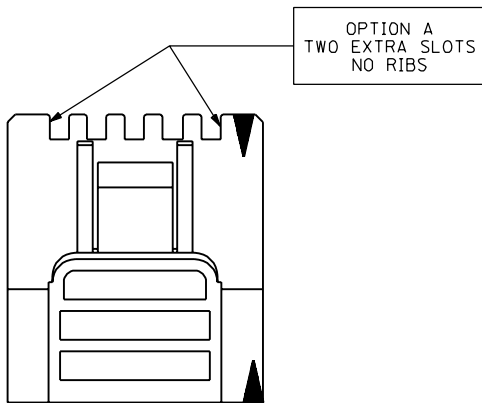

NOTES:

- 1) MATERIAL: GLASS FILLED POLYESTER, 94V-0, BLACK
- 2) MOLD TO BE EXPANDABLE FOR CIRCUIT SIZES LISTED ON CHART.
- 3) 10 CIRCUIT, B OPTION PART SHOWN.
- 4) OPTION "A" - MATES WITH HEADERS 8723-B, 8723-C, 8724-B, 8724-C, 70227, 70229, AND 70022. OPTION "B" - MATES WITH HEADERS 8723-C, 8724-C, 70227, 700229, AND 70022 (EXCEPT THE 50 CIRCUIT PARTS LISTED ON PAGE 4. SEE THE CHART ON PAGE 4 FOR MATING INTERIM CLIPS)
- 5) ALL DIMENSIONS FOR REFERENCE ONLY.
- 6) OPTIONAL SPRING CLIP FOR GREATER RETENTION OF MODULES IS RECOMMENDED FOR CIRCUIT SIZES 18-50. PART NUMBER 71809.
- 7) PACKAGE PER PK-70013-100.

M	ADD PKG NOTE ECN UDT2000-0468 SCHAFFER 99/12/1	LI	REVISE PER ECR #U80583 10/10/97 HPA
L3	CLEAN UP DWG PER UDT1999-0522 99/01/05 KAS	L	REVISE PER ECR #U80062 3/1/88 MJM
L2	REVISE PER ECR #UDT1998-0206 98/01/09 HPA	K	REVISE TOP WALL & ANTI-FISH HOOK RIBS PER ECR#9622 1/17/87 MJM/JAS
LTR.	REVISIONS	LTR.	REVISIONS

DIMENSIONS SHOWN (METRIC) INCH UNLESS OTHERWISE SPECIFIED TOLERANCES: ANGULAR ± 1/2°	
3 PLACE ± .010	---
2 PLACE ± .015	± 0.25
1 PLACE ---	± 0.38
DRAFT WHERE APPLICABLE MUST REMAIN WITHIN DIMENSIONS	
DRWL. BY: DJB	CHK'D. BY: DB
APP'D. BY: WZ	SCALE: 4:1

▽ = 0	▼ = 0	REVISE ONLY ON CAD SYSTEM	
TITLE: DUAL ROW INTERIM CLIP .100 GRID			
MOLEX INCORPORATED LISLE, ILL. 60532		SHEET NO. 1 OF 4	DATE 06/23/86
PART NO. SD-70013-0001-1050		DRWG. NO. U.S.A.	
SEE CHART		FILE NAME: ST0013X1.DWG	
THIS DRAWING CONTAINS INFORMATION THAT IS PROPRIETARY TO MOLEX INC. AND SHOULD NOT BE USED WITHOUT WRITTEN PERMISSION.			
DP	C	DP	C

4	L2
3	L1
2	L3
1	M
MFG. SH. REV.	

70013

D

C

B

A

38 CKT.
19 CKT. DUAL
ROW - ODD

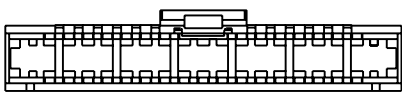
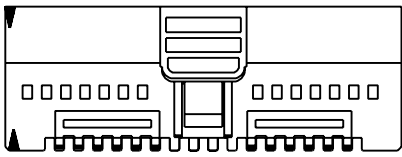

40 CKT.
20 CKT. DUAL
ROW - EVEN

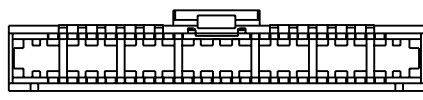
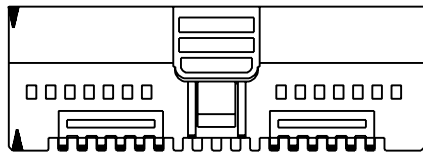

42 CKT.
21 CKT. DUAL
ROW - ODD

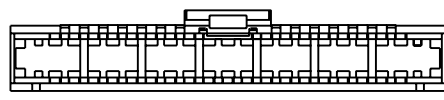
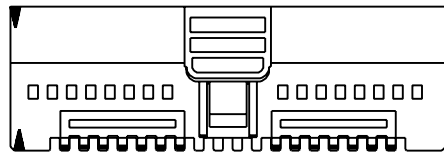

44 CKT.
22 CKT. DUAL
ROW - EVEN

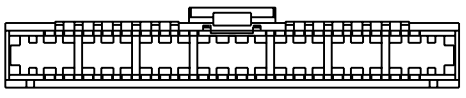
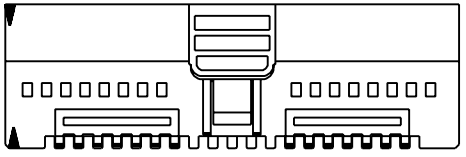

46 CKT.
23 CKT. DUAL
ROW - ODD

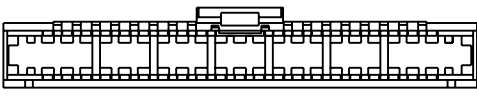
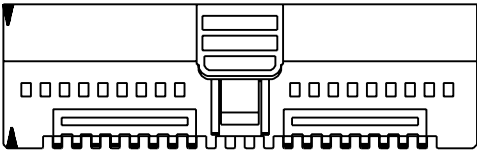

48 CKT.
24 CKT. DUAL
ROW - EVEN

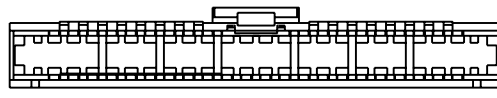
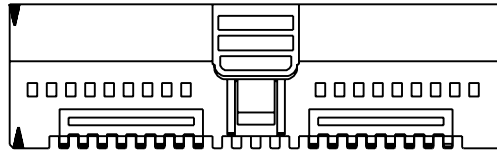

50 CKT.
25 CKT. DUAL
ROW - ODD

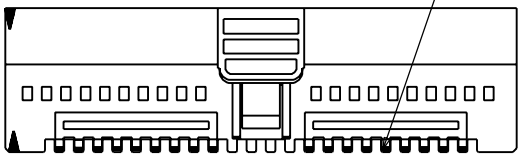

CASTLES BETWEEN SUPPORT RIBS OPTIONAL (50 CIRCUIT ONLY)

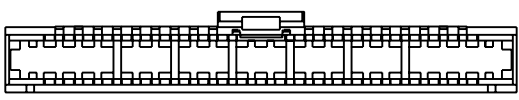

LI	SEE SHEET I
L	SEE SHEET I
K	SEE SHEET I
J	SEE SHEET I

DIMENSIONS SHOWN (METRIC) INCH UNLESS OTHERWISE SPECIFIED TOLERANCES ANGULAR ± 1/2°		REVISIONS																					
<table border="1"> <tr> <th>PLACE</th> <th>INCH</th> <th>METRIC</th> </tr> <tr> <td>3 PLACE</td> <td>± .010</td> <td>---</td> </tr> <tr> <td>2 PLACE</td> <td>± .015</td> <td>± 0.25</td> </tr> <tr> <td>1 PLACE</td> <td>---</td> <td>± 0.38</td> </tr> </table>		PLACE	INCH	METRIC	3 PLACE	± .010	---	2 PLACE	± .015	± 0.25	1 PLACE	---	± 0.38	<table border="1"> <tr> <td>MFG. SH.</td> <td>REV.</td> <td>LTR.</td> <td>REVISIONS</td> </tr> <tr> <td></td> <td></td> <td></td> <td></td> </tr> </table>		MFG. SH.	REV.	LTR.	REVISIONS				
PLACE	INCH	METRIC																					
3 PLACE	± .010	---																					
2 PLACE	± .015	± 0.25																					
1 PLACE	---	± 0.38																					
MFG. SH.	REV.	LTR.	REVISIONS																				
<table border="1"> <tr> <td>DRWG. BY: DJB</td> <td>CHK'D. BY: DB</td> </tr> <tr> <td>APP'D. BY: WZ</td> <td>SCALE: 2:1</td> </tr> </table>		DRWG. BY: DJB	CHK'D. BY: DB	APP'D. BY: WZ	SCALE: 2:1	<table border="1"> <tr> <td>FILE NAME: S70013X3.DWG</td> <td>THIS DRAWING CONTAINS INFORMATION THAT IS PROPRIETARY TO MOLEX INC. AND SHOULD NOT BE USED WITHOUT WRITTEN PERMISSION.</td> </tr> </table>		FILE NAME: S70013X3.DWG	THIS DRAWING CONTAINS INFORMATION THAT IS PROPRIETARY TO MOLEX INC. AND SHOULD NOT BE USED WITHOUT WRITTEN PERMISSION.														
DRWG. BY: DJB	CHK'D. BY: DB																						
APP'D. BY: WZ	SCALE: 2:1																						
FILE NAME: S70013X3.DWG	THIS DRAWING CONTAINS INFORMATION THAT IS PROPRIETARY TO MOLEX INC. AND SHOULD NOT BE USED WITHOUT WRITTEN PERMISSION.																						
<table border="1"> <tr> <td>PART NO. SEE CHART</td> <td>DRWG. NO. SD-70013-0001-1050</td> </tr> </table>		PART NO. SEE CHART	DRWG. NO. SD-70013-0001-1050	<table border="1"> <tr> <td>SHEET NO. 3</td> <td>DATE 06/26/86</td> </tr> </table>		SHEET NO. 3	DATE 06/26/86																
PART NO. SEE CHART	DRWG. NO. SD-70013-0001-1050																						
SHEET NO. 3	DATE 06/26/86																						