

PLEASE CHECK WWW.MOLEX.COM FOR LATEST PART INFORMATION

Part Number: [0459848222](#)
Status: **Active**
Overview: [extreme_lphpower](#)
Description: 1.27mm (.050"), 12.00mm (.472") Pitch, EXTreme LPHPower™ Receptacle Header, Right Angle, 8 Power Contacts, 16 Signal Contacts, Select Gold (Au) Plating, for 2.36mm (.093") Thick PC Board, with Guide Posts

Documents:

[3D Model](#) [Product Specification PS-45984-001 \(PDF\)](#)
[Drawing \(PDF\)](#) [RoHS Certificate of Compliance \(PDF\)](#)

Agency Certification

CSA LR19980
 UL E29179

General

Product Family PCB Receptacles
 Series [45984](#)
 Application Board-to-Board
 Overview [extreme_lphpower](#)
 Product Name EXTreme LPHPower™

Physical

Circuits (Loaded) 24
 Circuits (maximum) 24
 Circuits Detail 8 Power, 16 Signal
 Color - Resin Black
 Durability (mating cycles max) 250
 Flammability 94V-0
 Glow-Wire Compliant No
 Guide to Mating Part Yes
 Keying to Mating Part Yes
 Lock to Mating Part No
 Material - Metal High Performance Alloy (HPA), Phosphor Bronze
 Material - Plating Mating Gold
 Material - Plating Termination Tin
 Material - Resin High Temperature Thermoplastic
 Number of Rows 2
 Orientation Right Angle
 PC Tail Length (in) 0.142 In
 PC Tail Length (mm) 3.60 mm
 PCB Locator No
 PCB Retention None
 PCB Thickness Recommended (in) 0.093 In
 PCB Thickness Recommended (mm) 2.36 mm
 Packaging Type Tray
 Pitch - Mating Interface (in) 0.050 In, 0.472 In
 Pitch - Mating Interface (mm) 1.27 mm, 12.00 mm
 Plating min: Mating (µin) 30
 Plating min: Mating (µm) 0.75
 Plating min: Termination (µin) 150, 75
 Plating min: Termination (µm) 1.875, 3.75
 Polarized to Mating Part Yes
 Polarized to PCB Yes
 Stackable No
 Surface Mount Compatible (SMC) Yes

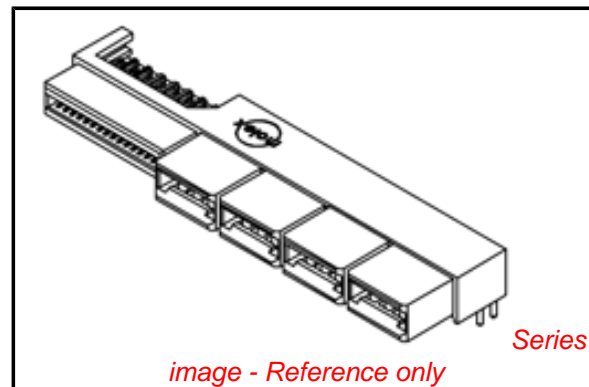

image - Reference only

EU RoHS

ELV and RoHS Compliant
REACH SVHC Contains SVHC: No
Halogen-Free Status

China RoHS



Need more information on product environmental compliance?

Email productcompliance@molex.com
 For a multiple part number RoHS Certificate of Compliance, [click here](#)

Please visit the [Contact Us](#) section for any non-product compliance questions.

Search Parts in this Series

[45984Series](#)

Mates With

[45985](#) EXTreme LPHPower™ Headers, 1.57mm (.062") Card Edge

Temperature Range - Operating -40°C to +105°C
Termination Interface: Style Through Hole

Electrical

Current - Maximum per Contact 23A
Grounding to PCB No
Voltage - Maximum 250V AC (RMS)/DC

Solder Process Data

Duration at Max. Process Temperature (seconds) 20
Lead-free Process Capability Wave Capable (TH only)
Max. Cycles at Max. Process Temperature 3
Process Temperature max. C 260

Material Info

Reference - Drawing Numbers

Packaging Specification PK-45984-001
Product Specification PS-45984-001
Sales Drawing SD-45984-800

This document was generated on 05/21/2010

PLEASE CHECK WWW.MOLEX.COM FOR LATEST PART INFORMATION



- NOTES:
1. MATERIAL HOUSING: LCP, 94V-0, COLOR-BLACK.
CONTACT: COPPER ALLOY.
 2. FINISH: SELECT GOLD - .762 μM/30 MI MIN. CONTACT AREA.
SELECT TIN - 3.81 μM/150 MI MIN. TAIL AREA.
BOTH OVER NICKEL - 1.27 μM/50 MI MIN.
 3. POWER TERMINALS LUBRICATED IN CONTACT AREA.
 4. PRODUCT SPECIFICATION: PS-45984-001.
 5. PACKAGING: TRAY PER PK-45984-001.
 6. SEE SHEET 5 FOR CKT IDENTIFICATION.
 7. PARTS ARE RoHS COMPLIANT.
 8. PEG HOLES ARE OPTIONAL SEE SHEET 3 AND 4.
 9. MATES TO 1.57/.062 CARD EDGE OR MOLEX P/N 45985-8***.

| NO OF SIGNAL | MATERIAL NUMBER | DIM A | DIM P | PCB THK |
|--------------|-----------------|-------|-------|---------|
| 12 | 45984-8111 | 59.5 | 4.50 | 3.18 |
| 16 | 45984-8121 | 62.0 | | |
| 20 | 45984-8131 | 64.6 | | |
| 24 | 45984-8141 | 67.1 | | |
| 28 | 45984-8151 | 69.6 | 3.60 | 2.36 |
| 32 | 45984-8161 | 72.2 | | |
| 36 | 45984-8171 | 74.7 | | |
| 40 | 45984-8181 | 77.3 | | |
| 12 | 45984-8112 | 59.5 | 2.90 | 1.57 |
| 16 | 45984-8122 | 62.0 | | |
| 20 | 45984-8132 | 64.6 | | |
| 24 | 45984-8142 | 67.1 | | |
| 28 | 45984-8152 | 69.6 | 2.90 | 1.57 |
| 32 | 45984-8162 | 72.2 | | |
| 36 | 45984-8172 | 74.7 | | |
| 40 | 45984-8182 | 77.3 | | |
| 12 | 45984-8113 | 59.5 | 2.90 | 1.57 |
| 16 | 45984-8123 | 62.0 | | |
| 20 | 45984-8133 | 64.6 | | |
| 24 | 45984-8143 | 67.1 | | |
| 28 | 45984-8153 | 69.6 | 2.90 | 1.57 |
| 32 | 45984-8163 | 72.2 | | |
| 36 | 45984-8173 | 74.7 | | |
| 40 | 45984-8183 | 77.3 | | |

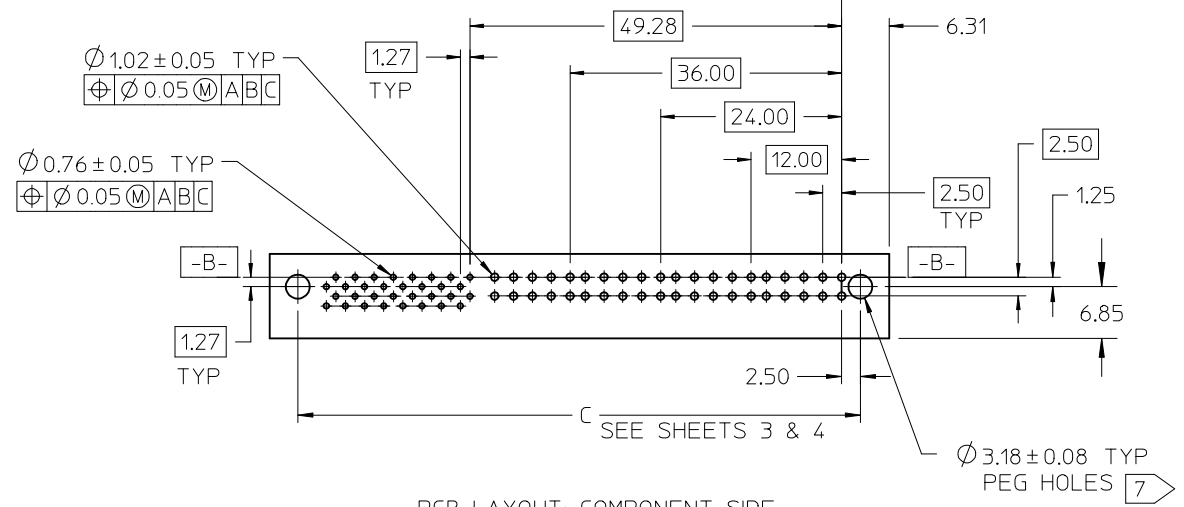

PCB LAYOUT: COMPONENT SIDE
PEG HOLES OPTIONAL



45984-8161 SHOWN
FOR REF ONLY
SEE CHART

| | |
|---------------------|-------------|
| REVISED | DESCRIPTION |
| EC NO: UCP2009-0971 | 2008/11/13 |
| DRWN:MBANDURA | 2008/11/14 |
| CHKD: | |
| APPR:APATEL | 2008/11/17 |
| REV | |

| | |
|--|--------------|
| GENERAL TOLERANCES (UNLESS SPECIFIED) | |
| | mm INCH |
| 4 PLACES | ± --- ± --- |
| 3 PLACES | ± --- ± --- |
| 2 PLACES | ± 0.25 ± --- |
| 1 PLACE | ± --- ± --- |
| ANGULAR ± 1/2° | |
| DRAFT WHERE APPLICABLE MUST REMAIN WITHIN DIMENSIONS | |

| | |
|----------------------------|------------|
| DIMENSION STYLE MM ONLY | |
| DRAWN BY | DATE |
| SAMIEC | 2005/05/13 |
| CHECKED BY | DATE |
| SAMIEC | 2005/05/13 |
| APPROVED BY | DATE |
| MARGULIS | 2005/05/13 |
| MATERIAL NO. SEE CHART | |
| SIZE | |
| A | |

| | | |
|--|------------------------|---------------------------|
| SCALE 1:1 | DESIGN UNITS METRIC | THIRD ANGLE PROJECTION |
| TITLE LPH RECEPTACLE ASSEMBLY RT ANGLE 8 CIRCUIT POWER CONNECTOR | | |
| MOLEX INCORPORATED | | |
| DOCUMENT NO. SD-45984-800 | SHEET NO. 1 OF 5 | |
| THIS DRAWING CONTAINS INFORMATION THAT IS PROPRIETARY TO MOLEX INCORPORATED AND SHOULD NOT BE USED WITHOUT WRITTEN PERMISSION | | |

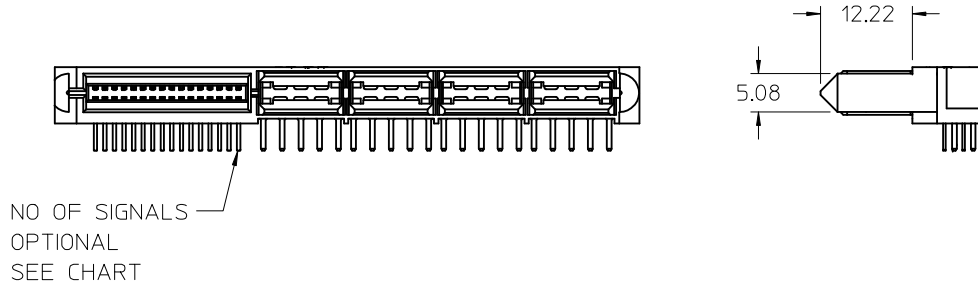
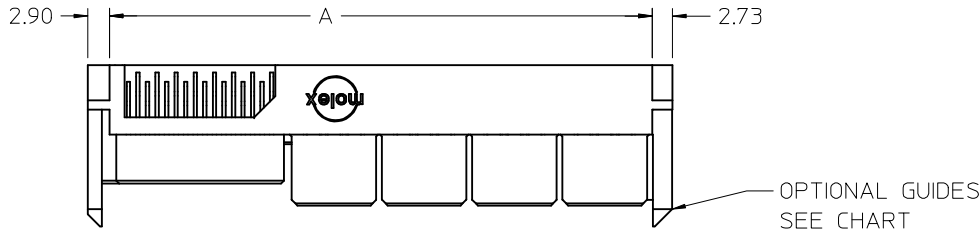

GUIDE POST OPTIONS

| NO OF SIGNAL | MATERIAL NUMBER | DIM A | DIM P | PCB THK |
|--------------|-----------------|-------|-------|---------|
| 12 | 45984-8211 | 59.5 | 4.50 | 3.18 |
| 16 | 45984-8221 | 62.0 | | |
| 20 | 45984-8231 | 64.6 | | |
| 24 | 45984-8241 | 67.1 | | |
| 28 | 45984-8251 | 69.6 | | |
| 32 | 45984-8261 | 72.2 | 3.60 | 2.36 |
| 36 | 45984-8271 | 74.7 | | |
| 40 | 45984-8281 | 77.3 | | |
| 12 | 45984-8212 | 59.5 | | |
| 16 | 45984-8222 | 62.0 | | |
| 20 | 45984-8232 | 64.6 | 2.90 | 1.57 |
| 24 | 45984-8242 | 67.1 | | |
| 28 | 45984-8252 | 69.6 | | |
| 32 | 45984-8262 | 72.2 | | |
| 36 | 45984-8272 | 74.7 | | |
| 40 | 45984-8282 | 77.3 | 2.90 | 1.57 |
| 12 | 45984-8213 | 59.5 | | |
| 16 | 45984-8223 | 62.0 | | |
| 20 | 45984-8233 | 64.6 | | |
| 24 | 45984-8243 | 67.1 | 2.90 | 1.57 |
| 28 | 45984-8253 | 69.6 | | |
| 32 | 45984-8263 | 72.2 | | |
| 36 | 45984-8273 | 74.7 | | |
| 40 | 45984-8283 | 77.3 | | |

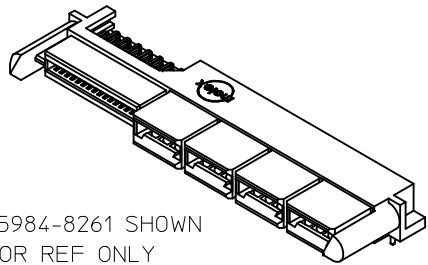

45984-8261 SHOWN FOR REF ONLY SEE CHART

| | |
|--------------------------|-------------|
| REVISED | DESCRIPTION |
| EC NO: UCP2009-0971 | |
| DRWN:MBANDURA 2008/11/13 | |
| CHKD: 2008/11/14 | |
| APPR:APATEL 2008/11/17 | |
| REV | |

| | |
|--|--------------|
| GENERAL TOLERANCES (UNLESS SPECIFIED) | |
| | mm INCH |
| 4 PLACES | ± --- ± --- |
| 3 PLACES | ± --- ± --- |
| 2 PLACES | ± 0.25 ± --- |
| 1 PLACE | ± --- ± --- |
| ANGULAR ±1/2° | |
| DRAFT WHERE APPLICABLE MUST REMAIN WITHIN DIMENSIONS | |

| | |
|-----------------|------------|
| DIMENSION STYLE | |
| MM ONLY | |
| DRAWN BY | DATE |
| SAMIEC | 2005/05/13 |
| CHECKED BY | DATE |
| SAMIEC | 2005/05/13 |
| APPROVED BY | DATE |
| MARGULIS | 2005/05/13 |
| MATERIAL NO. | |
| SEE CHART | |
| SIZE | |
| A | |

| | | | |
|---|--------------|------------------------|--|
| SCALE | DESIGN UNITS | THIRD ANGLE PROJECTION | |
| 1:1 | METRIC | | |
| TITLE | | | |
| LPH RECEPTACLE ASSEMBLY RT ANGLE 8 CIRCUIT POWER CONNECTOR | | | |
| molex MOLEX INCORPORATED | | | |
| DOCUMENT NO. | | SHEET NO. | |
| SD-45984-800 | | 2 OF 5 | |
| THIS DRAWING CONTAINS INFORMATION THAT IS PROPRIETARY TO MOLEX INCORPORATED AND SHOULD NOT BE USED WITHOUT WRITTEN PERMISSION | | | |

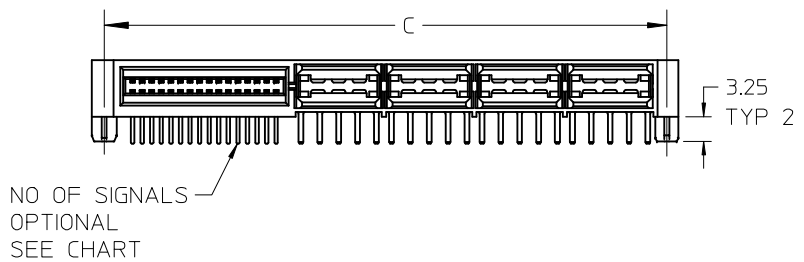

MOUNTING PEG OPTIONS

| NO OF SIGNAL | MATERIAL NUMBER | DIM A | DIM C | DIM P | PCB THK |
|--------------|-----------------|-------|-------|-------|---------|
| 12 | 45984-8311 | 59.5 | 61.90 | 4.50 | 3.18 |
| 16 | 45984-8321 | 62.0 | 64.44 | | |
| 20 | 45984-8331 | 64.6 | 66.98 | | |
| 24 | 45984-8341 | 67.1 | 69.52 | | |
| 28 | 45984-8351 | 69.6 | 72.06 | | |
| 32 | 45984-8361 | 72.2 | 74.60 | | |
| 36 | 45984-8371 | 74.7 | 77.14 | 3.60 | 2.36 |
| 40 | 45984-8381 | 77.3 | 79.68 | | |
| 12 | 45984-8312 | 59.5 | 61.90 | | |
| 16 | 45984-8322 | 62.0 | 64.44 | | |
| 20 | 45984-8332 | 64.6 | 66.98 | | |
| 24 | 45984-8342 | 67.1 | 69.52 | | |
| 28 | 45984-8352 | 69.6 | 72.06 | 2.90 | 1.57 |
| 32 | 45984-8362 | 72.2 | 74.60 | | |
| 36 | 45984-8372 | 74.7 | 77.14 | | |
| 40 | 45984-8382 | 77.3 | 79.68 | | |
| 12 | 45984-8313 | 59.5 | 61.90 | | |
| 16 | 45984-8323 | 62.0 | 64.44 | | |
| 20 | 45984-8333 | 64.6 | 66.98 | | |
| 24 | 45984-8343 | 67.1 | 69.52 | | |
| 28 | 45984-8353 | 69.6 | 72.06 | | |
| 32 | 45984-8363 | 72.2 | 74.60 | | |
| 36 | 45984-8373 | 74.7 | 77.14 | | |
| 40 | 45984-8383 | 77.3 | 79.68 | | |



45984-8361 SHOWN
FOR REF ONLY
SEE CHART

| | | | | | | | | | |
|--|--|-------|-----------------------------------|-------------------------|--|--|---------------------------|--|--|
| REVISED EC NO: UCP2009-0971 DRWN:MBANDURA 2008/11/13 CHKD: 2008/11/14 APPR:APATEL 2008/11/17 DESCRIPTION REV | GENERAL TOLERANCES (UNLESS SPECIFIED) | | DIMENSION STYLE MM ONLY | | SCALE 1:1 | DESIGN UNITS METRIC | THIRD ANGLE PROJECTION | | |
| | | mm | INCH | DRAWN BY SAMIEC | DATE 2005/05/13 | TITLE LPH RECEPTACLE ASSEMBLY RT ANGLE 8 CIRCUIT POWER CONNECTOR | | | |
| | 4 PLACES | ± --- | ± --- | CHECKED BY SAMIEC | DATE 2005/05/13 | | | | |
| | 3 PLACES | ± --- | ± --- | APPROVED BY MARGULIS | DATE 2005/05/13 | MOLEX INCORPORATED DOCUMENT NO. SD-45984-800 | | | |
| 2 PLACES | ± 0.25 | ± --- | MATERIAL NO. SEE CHART | | SHEET NO. 3 OF 5 | | | | |
| 1 PLACE | ± --- | ± --- | ANGULAR ±1/2° | | THIS DRAWING CONTAINS INFORMATION THAT IS PROPRIETARY TO MOLEX INCORPORATED AND SHOULD NOT BE USED WITHOUT WRITTEN PERMISSION | | | | |
| DRAFT WHERE APPLICABLE MUST REMAIN WITHIN DIMENSIONS | | | | | | | | | |

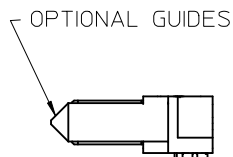
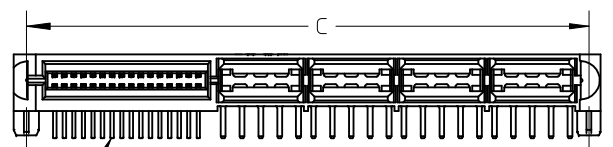

NO OF SIGNALS
OPTIONAL
SEE CHART

GUIDE POST & MOUNTING PEG OPTIONS

| NO OF SIGNAL | MATERIAL NUMBER | DIM A | DIM C | DIM P | PCB THK |
|--------------|-----------------|-------|-------|-------|---------|
| 12 | 45984-8411 | 59.5 | 61.90 | 4.50 | 3.18 |
| 16 | 45984-8421 | 62.0 | 64.44 | | |
| 20 | 45984-8431 | 64.6 | 66.98 | | |
| 24 | 45984-8441 | 67.1 | 69.52 | | |
| 28 | 45984-8451 | 69.6 | 72.06 | | |
| 32 | 45984-8461 | 72.2 | 74.60 | | |
| 36 | 45984-8471 | 74.7 | 77.14 | 3.60 | 2.36 |
| 40 | 45984-8481 | 77.3 | 79.68 | | |
| 12 | 45984-8412 | 59.5 | 61.90 | | |
| 16 | 45984-8422 | 62.0 | 64.44 | | |
| 20 | 45984-8432 | 64.6 | 66.98 | | |
| 24 | 45984-8442 | 67.1 | 69.52 | | |
| 28 | 45984-8452 | 69.6 | 72.06 | 2.90 | 1.57 |
| 32 | 45984-8462 | 72.2 | 74.60 | | |
| 36 | 45984-8472 | 74.7 | 77.14 | | |
| 40 | 45984-8482 | 77.3 | 79.68 | | |
| 12 | 45984-8413 | 59.5 | 61.90 | | |
| 16 | 45984-8423 | 62.0 | 64.44 | | |
| 20 | 45984-8433 | 64.6 | 66.98 | 2.90 | 1.57 |
| 24 | 45984-8443 | 67.1 | 69.52 | | |
| 28 | 45984-8453 | 69.6 | 72.06 | | |
| 32 | 45984-8463 | 72.2 | 74.60 | | |
| 36 | 45984-8473 | 74.7 | 77.14 | | |
| 40 | 45984-8483 | 77.3 | 79.68 | | |

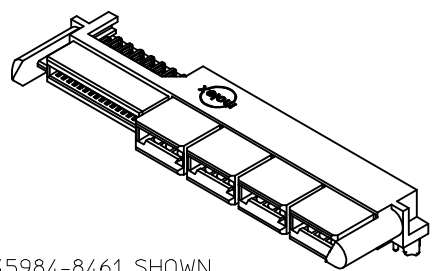

45984-8461 SHOWN
FOR REF ONLY
SEE CHART

| | | | | |
|---------------|---------------------|-------------|-------------|------------|
| REVISED | EC NO: UCP2009-0971 | 2008/11/13 | 2008/11/14 | 2008/11/17 |
| DRWN:MBANDURA | CHKD: | APPR:APATEL | DESCRIPTION | |
| REV | | | | |

| | | |
|--|--------|-------|
| GENERAL TOLERANCES (UNLESS SPECIFIED) | | |
| | mm | INCH |
| 4 PLACES | ± --- | ± --- |
| 3 PLACES | ± --- | ± --- |
| 2 PLACES | ± 0.25 | ± --- |
| 1 PLACE | ± --- | ± --- |
| ANGULAR ±1/2° | | |
| DRAFT WHERE APPLICABLE MUST REMAIN WITHIN DIMENSIONS | | |

| | |
|-----------------|------------|
| DIMENSION STYLE | |
| MM ONLY | |
| DRAWN BY | DATE |
| SAMIEC | 2005/05/13 |
| CHECKED BY | DATE |
| SAMIEC | 2005/05/13 |
| APPROVED BY | DATE |
| MARGULIS | 2005/05/13 |
| MATERIAL NO. | |
| SEE CHART | |

| | | | |
|---|--------------|------------------------|-----------|
| SCALE | DESIGN UNITS | THIRD ANGLE PROJECTION | |
| 1:1 | METRIC | | |
| TITLE | | | |
| LPH RECEPTACLE ASSEMBLY RT ANGLE 8 CIRCUIT POWER CONNECTOR | | | |
| MOLEX INCORPORATED | | | |
| DOCUMENT NO. | | | SHEET NO. |
| SD-45984-800 | | | 4 OF 5 |
| THIS DRAWING CONTAINS INFORMATION THAT IS PROPRIETARY TO MOLEX INCORPORATED AND SHOULD NOT BE USED WITHOUT WRITTEN PERMISSION | | | |



| NO. OF SIGNAL | DIM. D |
|---------------|--------|
| 12 | 8.00 |
| 16 | 10.54 |
| 20 | 13.08 |
| 24 | 15.62 |
| 28 | 18.16 |
| 32 | 20.70 |
| 36 | 23.24 |
| 40 | 25.78 |

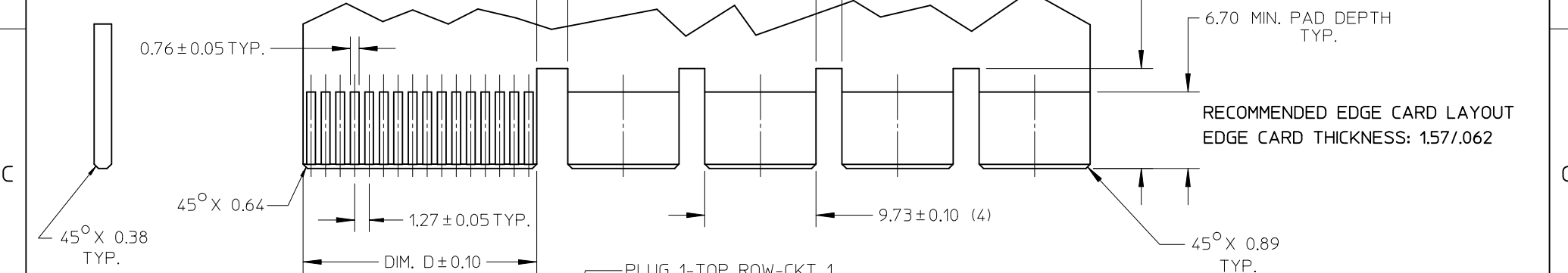

RECOMMENDED EDGE CARD LAYOUT
EDGE CARD THICKNESS: 1.57/0.62

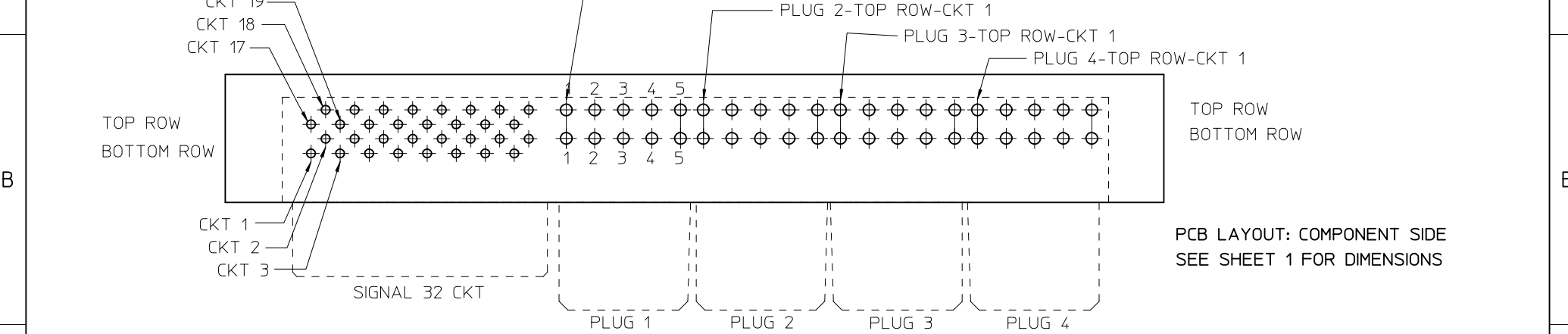

| | | | | | |
|---------------|---------------------|-------------|------------|------------|-------------|
| REVISED | EC NO: UCP2009-0971 | 2008/11/13 | 2008/11/14 | 2008/11/17 | DESCRIPTION |
| DRWN:MBANDURA | CHKD: | APPR:APATEL | | | |
| REV | | | | | |

| | |
|--|--------------|
| GENERAL TOLERANCES (UNLESS SPECIFIED) | |
| | mm INCH |
| 4 PLACES | ± --- ± --- |
| 3 PLACES | ± --- ± --- |
| 2 PLACES | ± 0.25 ± --- |
| 1 PLACE | ± --- ± --- |
| ANGULAR ± 1/2° | |
| DRAFT WHERE APPLICABLE MUST REMAIN WITHIN DIMENSIONS | |

| | |
|-----------------|------------|
| DIMENSION STYLE | |
| MM ONLY | |
| DRAWN BY | DATE |
| SAMIEC | 2005/05/13 |
| CHECKED BY | DATE |
| SAMIEC | 2005/05/13 |
| APPROVED BY | DATE |
| MARGULIS | 2005/05/13 |
| MATERIAL NO. | |

| | | |
|--|--------------|------------------------|
| SCALE | DESIGN UNITS | THIRD ANGLE PROJECTION |
| 2:1 | METRIC | |
| TITLE | | |
| LPH RECEPTACLE ASSEMBLY RT ANGLE 8 CIRCUIT POWER CONNECTOR | | |
| MOLEX INCORPORATED | | |
| DOCUMENT NO. | SHEET NO. | |
| SD-45984-800 | 5 OF 5 | |