

Features

- Compatible with IEEE 802.3/Ethernet (10BASE5), IEEE802.3/CHEAPERNET (10BASE2) and Ethernet Rev. 1 Specifications
- Compatible with 8003 ELDC®, 8005 Advanced EDLC and Intel 82586 LAN Controller
- Manchester Data Encoding/Decoding and Receiver Clock Recovery with Phase Locked Loop (PLL)
- Receiver and Collision Squelch Circuit and Noise Rejection Filter
- Differential TRANSMIT Cable Driver
- Loopback Capability for Diagnostics and Isolation
- Fall-Safe Watchdog Timer Circuit to Prevent Continuous Transmission
- 20 MHz Crystal Oscillator
- Transceiver Interface High Voltage (16 V) Short Circuit Protection
- Low Power CMOS Technology with Single 5V Supply
- 20 pin DIP (Commercial) & 20 pin PLCC Packages (Commercial, Extended)

Temperature Ranges,

- Commercial 0°C to +70°C
- Extended -40°C to +85°C

Description

The SEEQ 8023A Manchester Code Converter chip provides the Manchester data encoding and decoding functions of the Ethernet Local Area Network physical layer. It interfaces to the SEEQ 8003 and 8005 Ethernet Data Link Controllers or to the Intel 82586 LAN Controller and any standard Ethernet transceiver as defined by IEEE 802.3 and Ethernet Revision 1.

Pin Configuration

DUAL-IN-LINE
 TOP VIEW
 (Commercial Temp Only)

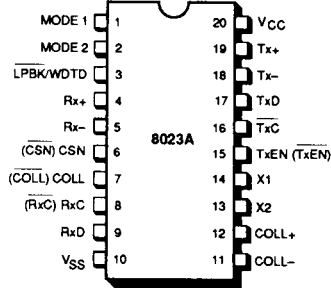

PLASTIC LEADED CHIP CARRIER
 TOP VIEW
 (Commercial and Extended Temps)

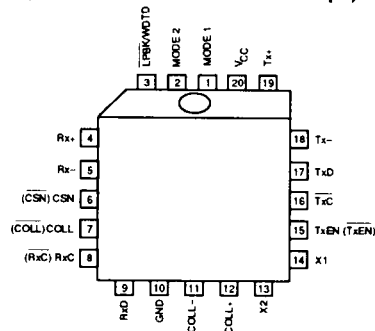

Functional Block Diagram

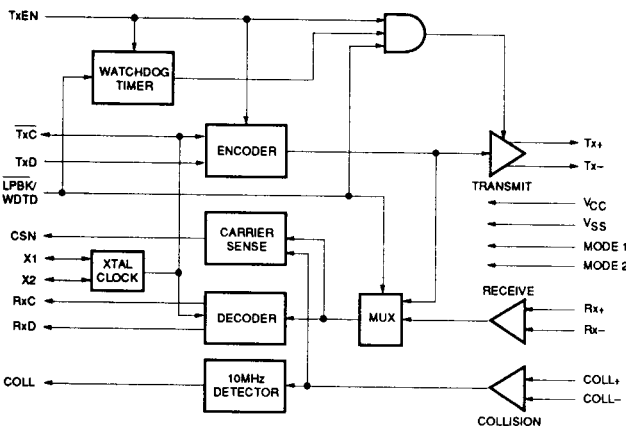

Figure 1. 8023A MCC Manchester Code Converter Block Diagram.

MCC is a trademark of SEEQ Technology, Inc.
 EDLC is a registered trademark of SEEQ Technology, Inc.

The SEEQ 8023A MCC is a functionally complete Encoder/Decoder including ECL level balanced driver and receivers, on board oscillator, analog phase locked loop for clock recovery and collision detection circuitry. In addition, the 8023A includes a 25 millisecond watchdog timer, a 4.5 microsecond window generator, and a loopback mode for diagnostic operation.

Together with the 8003 or 8005 and a transceiver, the 8023A Manchester Code Converter provides a high performance minimum cost interface for any system to Ethernet.

Functional Description

The 8023A Manchester Code Converter chip has two portions, transmitter and receiver. The transmitter uses Manchester encoding to combine the clock and data into a serial stream. It also differentially drives up to 50 meters of twisted pair transmission line. The receiver detects the presence of data and collisions. The 8023A MCC recovers the Manchester encoded data stream and decodes it into clock and data outputs. Manchester Encoding is the process of combining the clock and data stream so that they may be transmitted on a single twisted pair of wires, and the clock and data may be recovered accurately upon reception. Manchester encoding has the unique property of a transition at the center of each bit cell, a positive going transition for a "1", and a negative going transition for a "0" (See Figure 2). The encoding is accomplished by exclusive-ORing the clock and data prior to transmission, and the decoding by deriving the clock from the data with a phase locked loop.

Clock Generator

The internal oscillator is controlled by a 20 MHz parallel resonant crystal or by an external clock on X1. The 20 MHz

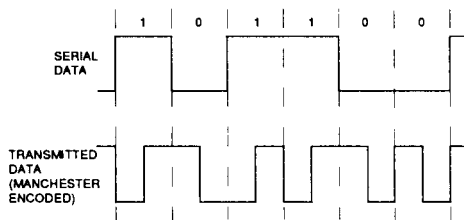

Figure 2. Manchester Coding

clock is then divided by 2 to generate a 10 MHz $\pm 0.01\%$ transmitter clock. Both 10 MHz and 20 MHz clocks are used in Manchester data encoding.

Manchester Encoder and Differential Output Driver

The encoder combines clock and data information for the transceiver. In Manchester encoding, the first half of the bit cell contains the complement of the data and the second half contains the true data. Thus, a transition is always guaranteed in the middle of a bit cell.

Data encoding and transmission begin with TxEN going active; the first transition is always positive for Tx(-) and negative for Tx(+). In IEEE mode, at the termination of a transmission, TxEN goes inactive and transmit pair approach to zero differential. In Ethernet mode, at the end of the transmission, TxEN goes inactive and the transmit pair stay differentially high. The transmit termination can occur at bit cell center if the last bit is a one or at a bit boundary if the last bit is a zero. To eliminate DC current in the transformer during idle, Tx \pm is brought to 100 mV differential in 600 ns after the last transition (IEEE mode). The back swing voltage is guaranteed to be less than .1 V.

Watchdog timer

A 25 ms watchdog timer is built on chip. It can be enabled or disabled by the $\overline{\text{LPBK/WDTD}}$ signal. The timer starts counting at the beginning of the transmission. If TxEN goes inactive before the timer expires, the timer is reset and ready for the next transmission. If the timer expires before the transmission ends, transmission is aborted by disabling the differential transmitter. This is done by idling the differential output drivers (differential output voltage becomes zero) and deasserting CSN.

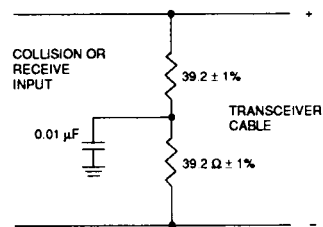

Figure 3. Differential Input Terminator

Differential Input Circuit (Rx+ and Rx-, COLL+ and COLL-)

As shown in Figure 3, the differential input for Rx+ and Rx- and COLL+ and COLL- are externally terminated by a pair of $39.2 \Omega \pm 1\%$ resistors in series for proper impedance matching.

The center tap has a $0.01 \mu\text{F}$ capacitor, tied to ground, to provide the AC common mode impedance termination for the transceiver cable.

Both collision and receiver input circuits provide a static noise margin of -140 mV to -300 mV (peak value). Noise rejection filters are provided at both input pairs to prevent spurious signals. For the receiver pair, the range is 15 ns to 30 ns. For the collision pair, the range is 10 ns to 18 ns. The D.C. threshold and noise rejection filter assure that differential receiver data signals less than -140 mV in amplitude or narrower than 15 ns (10 ns for collision pair) are always rejected, signals greater than -300 mV and wider than 30 ns (18 ns for collision pair) are always accepted.

Manchester Decoder and Clock Recovery Circuit

The filtered data is processed by the data and clock recovery circuit using a phase-locked loop technique. The PLL is designed to lock onto the preamble of the incoming signal with a transition width asymmetry not greater than $+8.25 \text{ ns}$ to -8.25 ns within 12 bit cell times worst case and can sample the incoming data with a transition width asymmetry of up to $+8.25 \text{ ns}$ to -8.25 ns . The RxC high or low time will always be greater than 40 ns. If MODE2 is high or floating, RxC will be held low for $1.2 \mu\text{s}$ maximum while the PLL is acquiring lock. If MODE2 is low, RxC follows $\overline{\text{TxC}}$ for the first $1.2 \mu\text{s}$ and then switches to the recovered clock. In addition, the Encoder/Decoder asserts the CSN signal while it is receiving data from the cable to indicate the receiver data and clock are valid and available. At the end of the frame, after the node has finished transmitting, CSN is deasserted and will not be asserted again for a period of $4.5 \mu\text{s}$ regardless of the state of the state of the receiver pair or collision pair. This is called the inhibit period. There is no inhibit period after packet reception. During clock switching, RxC may stay high for 200ns maximum.

Collision Circuit

A collision on the Ethernet cable is sensed by the transceiver. It generates a $10 \text{ MHz} \pm 15\%$ differential square wave to indicate the presence of the collision. During the collision period, CSN is asserted asynchronously with RxC. However, if a collision arrives during inhibit period $4.5 \mu\text{s}$ from the time CSN was deasserted, CSN will not be reasserted.

Loopback

In loopback mode, encoded data is switched to the PLL instead of Tx+/Tx- signals. The recovered data and clock are returned to the Ethernet Controller. All the transmit and receive circuits, including noise rejection filter, are tested except the differential output driver and the differential input receiver circuits which are disabled during loopback. At the end of frame transmission, the 8023A also generates a 650 ns long COLL signal 550 ns after CSN was deasserted to simulate the IEEE 802.3 SQE test. The watchdog timer remains enabled in this mode.

Pin Description

The MCC chip signals are grouped into four categories:

- Power Supply and Clock
- Controller Interface
- Transceiver Interface
- Miscellaneous

Power Supply

V_{CC}+5V
V_{SS}Ground

X1 and X2 clock (Inputs): Clock Crystal: 20 MHz crystal oscillator input. Alternately, pin X1 may be used at a TTL level input for external timing by floating pin X2.

Controller Interface

RxC ($\overline{\text{RxC}}$) Receive Clock (Output): This signal is the recovered clock from the phase decoder circuit. It is switched to $\overline{\text{RxC}}$ when no incoming data is present from which a true receive clock is derived. 10 MHz nominal and TTL compatible. If the MODE2 signal is high, RxC is inverted ($\overline{\text{RxC}}$) and there is a $1.25 \mu\text{sec}$ discontinuity at the beginning of frame reception.

RxD Receive Data (Output): The RxD signal is the recovered data from the phase decoder. During idle periods, the RxD pin is LOW under normal conditions. However, if the MODE2 signal is HIGH, the RxD output will be HIGH during idle. TTL and MOS level compatible. Active HIGH.

CSN ($\overline{\text{CSN}}$) Carrier Sense (Output): The Carrier Sense Signal indicates to the controller that there is activity on the coaxial cable. It is asserted when receive data is present or when a collision signal is present. It is deasserted at the end of frame or at the end of collision, whichever occurs later. It is asserted or deasserted synchronously with RxC. TTL compatible. Normally active HIGH, unless MODE2 is HIGH, in which case $\overline{\text{CSN}}$ is active LOW.

802.3 specification). When pin 1 is tied low, then the output is differentially high when idle (Ethernet Rev.1 specification).

MODE2 (Input): The MODE2 Input signal is normally active LOW. In this configuration, the 8032A operates in a mode compatible with the SEEQ 8003. An alternate mode of operation may be achieved by configuring the MODE signal active HIGH, or by allowing it to float HIGH with its internal pullup. In this configuration, RxC, TxEN, CSN and COLL become active LOW. In addition, RxD is HIGH during idle, and RxC has 1.2 μ s discontinuity during signal acquisition.

[LPBK/WDTD Loopback/Watchdog Timer Disable (Input):

Normal Operation: For normal operation this pin should be HIGH or tied to V_{CC} . In normal operation the watchdog timer is enabled.

Loopback: When this pin is brought low, the Manchester encoded transmit data from TxD and $\overline{\text{TxC}}$ is routed through the receiver circuit and sent back onto the RxD and RxC Pins. During loopback, Collision and Receive data inputs are ignored. The transmit pair is idled. At the end of transmission, the signal quality error test (SQET) will be simulated by asserting collision during the inhibit window. During loopback, the watchdog timer is enabled.

Watchdog Timer Disable: When this pin is between 10 V (Min.) and 16 V (Max.), the on chip 25 ms Watchdog Timer will be disabled. The watchdog timer is used to monitor the transmit enable pin. If TxEN is asserted for longer than 25 ms, then the watchdog timer (if enabled) will automatically deassert CSN and inhibit any further transmissions on the Tx+ and Tx- lines. The watchdog timer is automatically reset each time TxEN is deasserted.

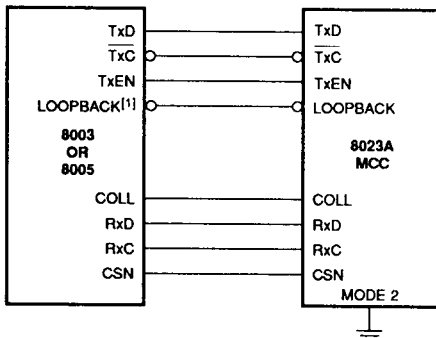

Figure 5. Interconnection of 8023A and 8003/8005

NOTE

1. Loopback output on 8005 only.

Interconnection to a Data Link Controller

Figure 5 shows the interconnections between the 8023A MCC and SEEQ's 8003 or 8005. There are three connections for each of the two transmission channels, transmit and receive, plus the Collision Signal line (COLL).

Transmitter connections are:

- Transmit Data, TxD
- Transmit Clock, $\overline{\text{TxC}}$
- Transmit Enable, TxEN
- Collision, COLL

Receiver connections are:

- Receive Data, RxD
- Receive Clock, RxC
- Carrier Sense, CSN

Compatibility with Other LAN Controllers

SEEQ's 8023A is compatible with other LAN Controllers, such as the 82586, when Pin 2 (MODE2) of the 8023A is floating or tied to V_{CC} . In this mode of operation, timing and polarity on the controller interface lines are compatible, with the 82586 specifications dated March 1984.

Use of Time Domain Reflectometry in the 82586 is not recommended since the TDR transmission does not have a valid preamble.

D.C. and A.C. Characteristics and Timing

Crystal Specification

Resonant Frequency ($C_L = 20$ pF)	20 MHz
	$\pm 0.005\%$ 0-70° C
	and $\pm 0.003\%$ at 25° C
Type	Fundamental Mode
Circuit	Parallel Resonance
Load Capacitance (C_L)	20pF
Shunt Capacitance (C_0)	7pF Max.
Equivalent Series Resistance (R_1)	25 Ω Max.
Motional Capacitance (C_1)	0.02 pF Max.
Drive Level	2mW

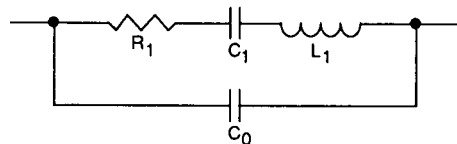

EQUIVALENT CIRCUIT OF CRYSTAL

Figure 6.



Absolute Maximum Range*

Storage Temperature	-65°C to +150°C
All Input or Output Voltage	-0.3 to $V_{CC} + 0.3$
V_{CC}	-0.3 to 7V
(Rx±, Tx±, COLL±) High Voltage	
Short Circuit Immunity	-0.3 to 16V

*COMMENT: Stresses above those listed under "Absolute Maximum Ratings" may cause permanent damage to the device. This is a stress rating only and functional operation of the device at these or any other conditions above those indicated in the operational sections of this specification is not implied. Exposure to absolute maximum rating conditions for extended periods may affect device reliability.

DC Characteristics T_A = Commercial 0°C to +70°C, T_C = Extended -40°C to +85°C; V_{CC} = 5 V ± 5%

Symbol	Parameter	Min.	Max.	Unit	Conditions
I_{IL}	Input Leakage Current (except MODE1, MODE2 Receive and Collision Pairs)		10	μ A	$0 \leq V_{IN} \leq V_{CC}$
	MODE1 Input Leakage Current		200	μ A	$0 \leq V_{IN} \leq V_{CC}$
	Receive and Collision Pairs(Rx±, COLL±) Input Leakage Current		2	mA	$V_{IN} = 0$
I_{CC}	V_{CC} Current		75	mA	All Inputs, Outputs Open
V_{IL}	TTL Input Low Voltage	-0.3	0.8	V	
V_{IH}	TTL Input High Voltage (except X1)	2.0	$V_{CC} + 0.3$	V	
	X1 Input High Voltage	3.5	$V_{CC} + 0.3$	V	
V_{OL}	TTL Output Low Voltage except \overline{TxC}		0.4	V	$I_{OL} = 2.1$ mA $I_{OL} = 4.2$ mA
	\overline{TxC} Output Low Voltage		0.4	V	
V_{OH}	TTL Output High Voltage (except Rx±, \overline{TxC} , Rx±D)	2.4		V	$t_{OH} = -400$ μ A $t_{OH} = -400$ μ A
	Rx±, \overline{TxC} , Rx±D Output High Voltage	3.9		V	
V_{ODF}	Differential Output Swing	±0.55	±1.2	V	78 Ω Termination Resistor and 243 Ω Load Resistors
V_{OCM}	Common Mode Output Voltage	$V_{CC} - 2.5$	$V_{CC} - 1$	V	78 Ω Termination Resistor and 243 Ω Load Resistors
V_{BKSV}	Tx± Backswing Voltage During Idle		0.1	V	Shunt Inductive Load ≤ 27 μ H
V_{IDF}	Input Differential Voltage (measured differentially)	±0.3	±1.2	V	
V_{ICM}	Input Common Mode Voltage	0	V_{CC}	V	
$C_{IN}^{(1)}$	Input Capacitance		15	pF	
$C_{OUT}^{(1)}$	Output Capacitance		15	pF	

NOTE:

1. Characterized. Not tested

A.C. Test Conditions

Output Loading TTL Output:

1 TTL gate and 20 pF capacitor.

Differential Output:

243Ω resistor and 10 pF capacitor from each pin to V_{SS} and a termination 78Ω resistor load resistor in parallel with a 27 μH inductor between the two differential output pins

Differential Signal Delay Time Reference Level:

50% point of swing

Differential Output Rise and Fall Time:

20% to 80% points

RxC, $\overline{\text{Tx}}\overline{\text{C}}$, X1 High and Low Time:

High time measured at 3.0V

Low time measured at 0.6V

RxD, RxC, $\overline{\text{Tx}}\overline{\text{C}}$, X1 Rise and Fall Time:

Measured between 0.6V and 3.0 V points

TTL Input Voltage (except X1):

0.8V to 2.0V with 10 ns rise and fall time

X1 Input Voltage:

0.8V to 3.5V with 5 ns rise and fall time

Differential Input Voltage:

At least ± 300 mV with rise and fall time of 10 ns measured between -0.2V and +0.2V

20 MHz TTL Clock Input Timing T_A = Commercial 0°C to +70°C, T_C = Extended -40°C to +85°C; V_{CC} = 5 V ± 5%

Symbol	Parameter	Min.	Max.	Unit
t_1	X1 Cycle Time	49.995	50.005	ns
t_2	X1 High Time	15		ns
t_3	X1 Low Time	15		ns
t_4	X1 Rise Time		5	ns
t_5	X1 Fall Time		5	ns
t_{5A}	X1 to $\overline{\text{Tx}}\overline{\text{C}}$ Delay Time	10	45	ns

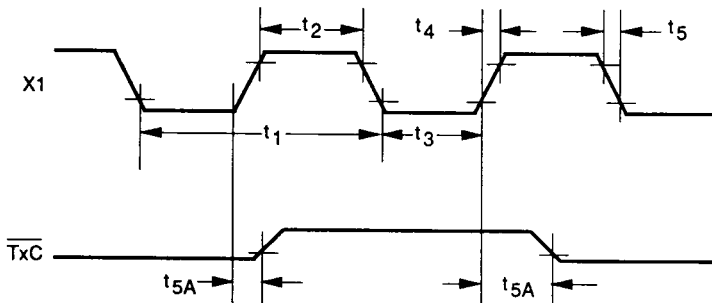

Figure 12. 20 MHz TTL Clock Timing

Transmit Timing T_A = Commercial 0°C to +70°C, T_C = Extended -40°C to +85°C; V_{CC} = 5 V ± 5%

Symbol	Parameter	Min.	Max.	Unit
$t_6^{[1]}$	$\overline{\text{TxC}}$ Cycle Time	99.99	100.01	ns
t_7	$\overline{\text{TxC}}$ High Time	40		ns
t_8	$\overline{\text{TxC}}$ Low Time	40		ns
$t_9^{[1]}$	$\overline{\text{TxC}}$ Rise Time		5	ns
$t_{10}^{[1]}$	$\overline{\text{TxC}}$ Fall Time		5	ns
t_{11}	TxEN Setup Time if Mode 2=0 TxEN Setup Time if Mode 2=1	40 55		ns ns
t_{12}	TxD Setup Time if Mode 2=0 TxD Setup Time if Mode 2=1	40 55		ns ns
$t_{13}^{[1]}$	Bit Center to Bit Center Time	99.5	100.5	ns
$t_{14}^{[1]}$	Bit Center to Bit Boundary Time	49.5	50.5	ns
$t_{15}^{[1]}$	Tx+ and Tx – Rise Time		5	ns
$t_{16}^{[1]}$	Tx+ and Tx – Fall Time		5	ns
t_{17}	Transmit Active Time From The Last Positive Transition	200		ns
$t_{17A}^{[1]}$	From Last Positive Transition of the Transmit Pair to Differential Output Approaches within 100 mV of 0 V	400	600	ns
$t_{17B}^{[1]}$	From Last Positive Transition of the Transmit Pair to Differential Output Approaches within 40 mV of 0 V		7000	ns
t_{18}	Tx+ and Tx– Output Delay Time		70	ns
t_{19}	TxD Hold Time if Mode 2=0 TxD Hold Time if Mode 2=1	15 0		ns ns
t_{20}	TxEN Hold Time if Mode 2=0 TxEN Hold Time if Mode 2=1	15 0		ns ns

NOTE:

1. Characterized. Not tested.

MODE1 = 1
MODE2 = 0

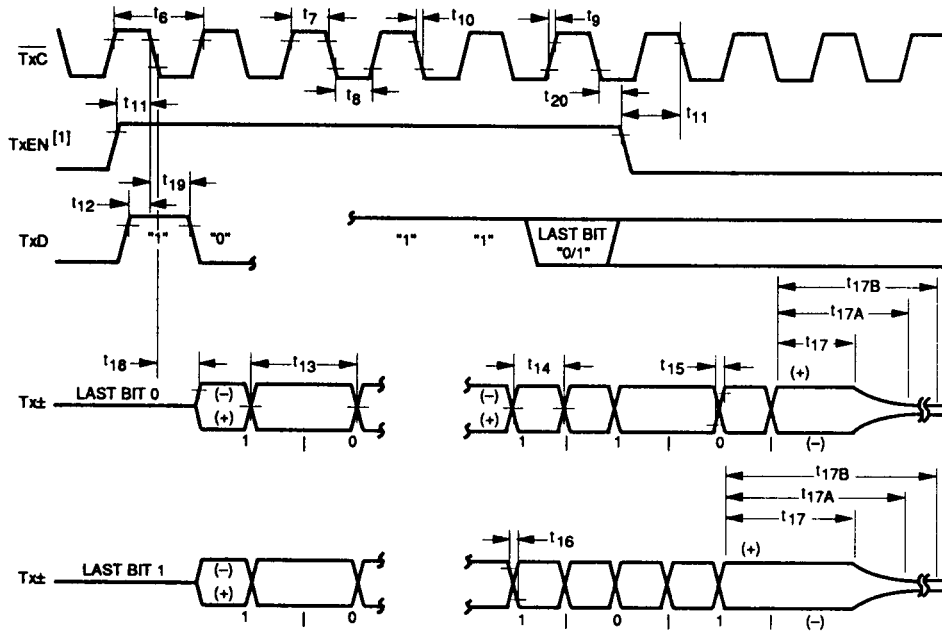

Figure 7. Transmit Timing

MODE1 = 0
MODE2 = 0

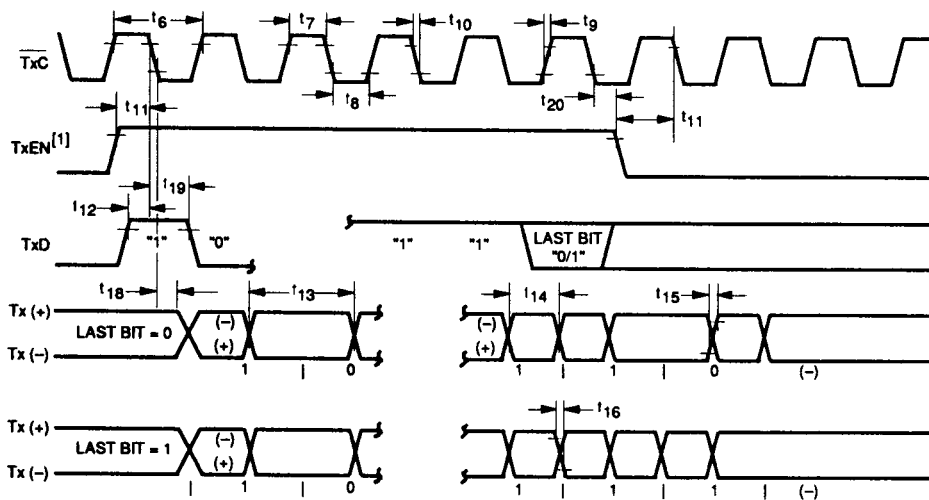

Figure 8. Transmit Timing

NOTE:

1. If MODE 2=1, TxEN becomes active low signal TxEN.

Receive Timing T_A = Commercial 0°C to +70°C, T_C = Extended -40°C to +85°C; V_{CC} = 5 V \pm 5%

Symbol	Parameter	Min.	Max.	Unit
t_{21}	CSN Assert Delay Time		240	ns
t_{22}	CSN Deasserts Delay Time (measured from Last Bit Boundary)		240	ns
t_{23A}	CSN Hold Time	30		ns
t_{23B}	CSN Set up Time	30		ns
t_{24}	CSN Deassertion Delay Time	10	35	ns
t_{25A}	RxD Hold Time	30		ns
t_{25B}	RxD Set up Time	30		ns
$t_{26}^{(1)}$	RxC, $\overline{\text{RxC}}$ Rise and Fall Time		5	ns
$t_{27}^{(1)}$	During Clock Switch RxC Keeps High, $\overline{\text{RxC}}$ Keeps Low Time	40	200	ns
t_{28}	RxC, $\overline{\text{RxC}}$ High and Low Time	40		ns
$t_{29}^{(1)}$	RxC, $\overline{\text{RxC}}$ Clock Cycle Time (during) Data Period	95	105	ns
t_{30}	CSN Inhibit Time (on Transmission Node only)	4.3	4.6	μ s
t_{31}	Rx+/Rx- Rise and Fall Time		10	ns
$t_{32}^{(1)}$	$\overline{\text{RxC}}$ Held Low Duration from First Valid Negative-Going Transition	1.15	1.35	μ s
t_{33}	$\overline{\text{RxC}}$ Stops Delay Time from First Valid Negative-Going Transition		240	ns
$t_{34}^{(1)}$	Rx+/Rx- Begin Return to Zero from Last Positive-Going Transition	160		ns
$t_{35}^{(1)}$	RxD Rise Time		10	ns
$t_{36}^{(1)}$	RxD Fall Time		10	ns

NOTE:

1. Characterized. Not tested.

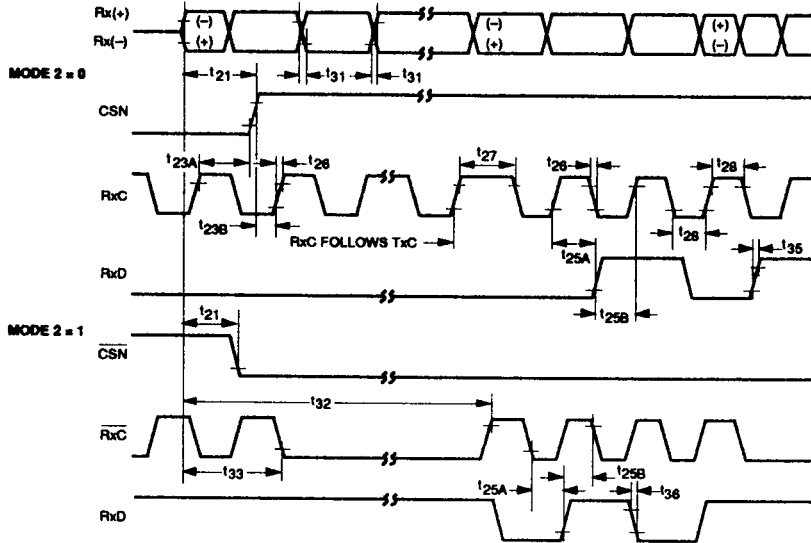

Figure 9. Receive Timing-Start of Packet

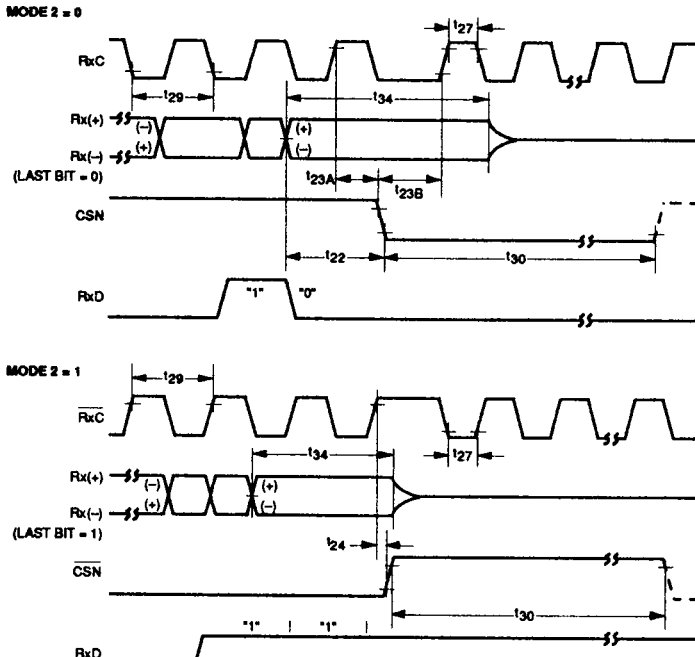

Figure 10. Receive Timing — End of Packet

Collision Timing T_A = Commercial 0°C to +70°C, T_C = Extended -40°C to +85°C; V_{CC} 5 V \pm 5%

Symbol	Parameter	Min.	Max.	Unit
t_{51}	COLL+ /COLL — Cycle Time	86	118	ns
t_{52}	COLL+ /COLL — Rise and Fall Time		10	ns
t_{53}	COLL+ /COLL — High and Low Time	35	70	ns
t_{54}	COLL+ /COLL — Width (measured at -0.3 V)	26		ns
t_{55}	COLL Asserts Delay Time		300	ns
t_{56}	COLL Deasserts Delay Time		500	ns
t_{57}	CSN Asserts Delay Time		400	ns
t_{58}	CSN Deasserts Delay Time		600	ns

NOTES:

- COLL + and COLL - asserts and deasserts COLL, asynchronously, and asserts and deasserts CSN synchronously with RxC.
- If COLL + and COLL - arrives within 4.5 μ s from the time CSN was deasserted; CSN will not be reasserted (on transmission node only).
- When COLL + and COLL - terminates, CSN will not be deasserted if Rx+ and Rx- are still active.
- When the node finishes transmitting and CSN is deasserted, it cannot be asserted again for 4.5 μ s.
- If MODE 2=1, then COLL and CSN are inverted.

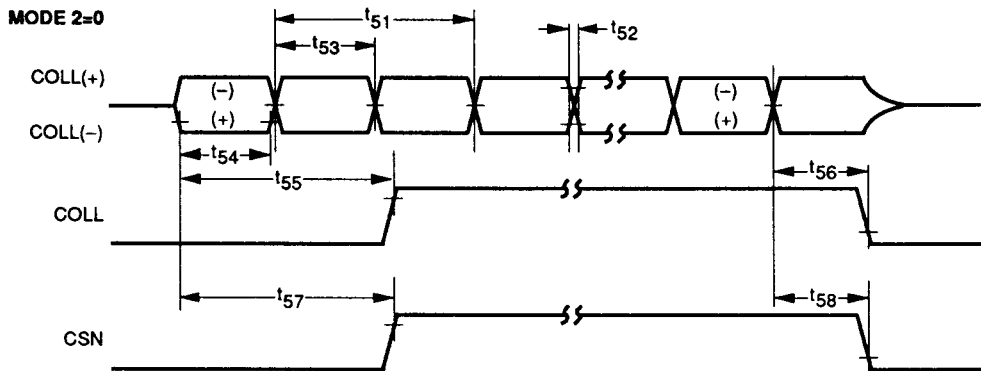

Figure 11. Collision Timing

