



Micro Commercial Components

Micro Commercial Components
20736 Marilla Street Chatsworth
CA91311
Phone: (818) 701-4933
Fax: (818) 701-4939

ESD5V0D3 Thru ESD12VD3

Features

- For sensitive ESD protection
- Excellent clamping capability
- Low leakage
- ESD rating of class 3(>16KV)per Human Body Mode
- For space saving application
- Fast response ,response time less than 1ns.
- Case Material: Molded Plastic. UL Flammability Classification Rating 94V-0 and MSL rating 1

Maximum Ratings

- Operating Junction &StorageTemperature: -55°C to +150°C
- Maximum Thermal Resistance: 625°C/W Junction To Ambient

Parameter	Symbol	Limits	unit
IEC61000-4-2(ESD) Air Contact		± 15 ± 8	KV
ESD Voltage per human body mode		30	KV
Power Dissipation	Pd	200	mw

5V~12Volts ESD Protection Devices

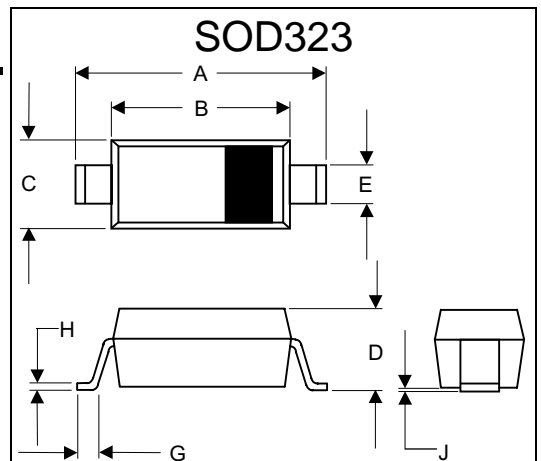

DIM	INCHES		MM		NOTE
	MIN	MAX	MIN	MAX	
A	.090	.107	2.30	2.70	
B	.063	.071	1.60	1.80	
C	.045	.053	1.15	1.35	
D	.031	.045	0.80	1.15	
E	.010	.016	0.25	0.40	
G	.004	.018	0.10	0.45	
H	.004	.010	0.10	0.25	
J	-----	.006	-----	0.15	

SUGGESTED SOLDER PAD LAYOUT

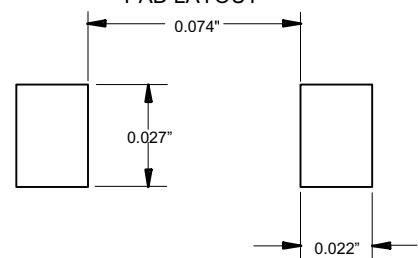

ELECTRICAL CHARACTERISTICS ($T_A = 25^\circ\text{C}$ unless otherwise noted)

Symbol	Parameter
I_{PP}	Maximum Reverse Peak Pulse Current
V_C	Clamping Voltage @ I_{PP}
V_{RWM}	Working Peak Reverse Voltage
I_R	Maximum Reverse Leakage Current @ V_{RWM}
V_{BR}	Breakdown Voltage @ I_T
I_T	Test Current
I_F	Forward Current
V_F	Forward Voltage @ I_F
P_{pk}	Peak Power Dissipation
C	Max. Capacitance @ $V_R=0$ and $f=1\text{MHz}$

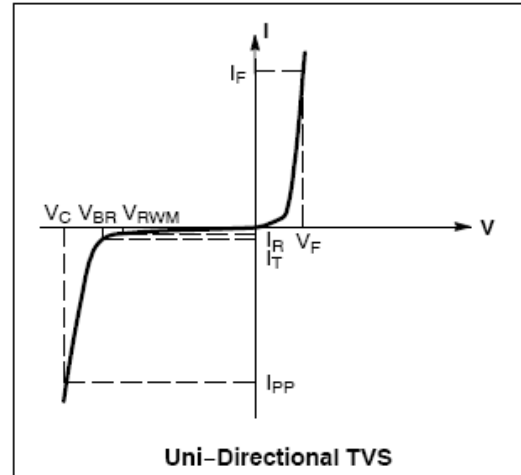

ELECTRICAL CHARACTERISTICS ($T_A = 25^\circ\text{C}$ unless otherwise noted, $V_F = 0.9\text{ V Max.}$ @ $I_F = 10\text{mA}$ for all types)

Device	Device Marking	V_{RWM}	$I_R (\mu\text{A})$	$V_{BR} (\text{V})$		I_T	V_C	$I_{PP}(\text{A})^+$	$V_C (\text{V})$	P_{pk}^+	C
		(V)	@ V_{RWM}	@ $I_T(\text{Note 2})$	Min		Max		@ $I_{PP} = 5\text{ A}$		
		Max	Max	Min	Max	mA	V	Max	Max	Max	Typ
ESD5V0D3	ZA	5.0	1.0	6.2	7.3	1.0	9.8	15	15.5	350	350
ESD12VD3	ZC	12	1.0	13.3	15.75	1.0	22	12	33	350	150

+Surge current waveform per Figure 6.

2. V_{BR} is measured with a pulse test current I_T at an ambient temperature of 25°C .

TYPICAL CHARACTERISTICS

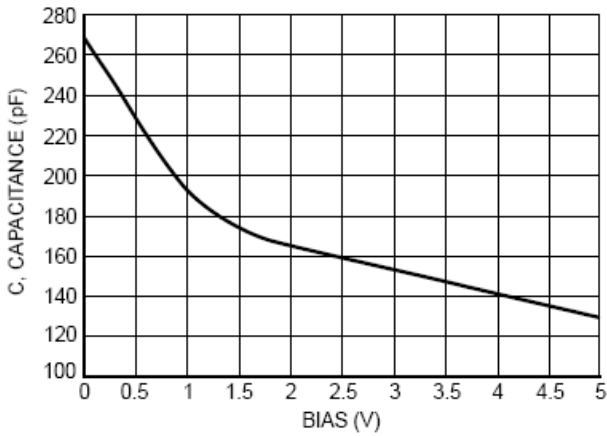

Figure 1. SD05 Typical Capacitance versus Bias Voltage

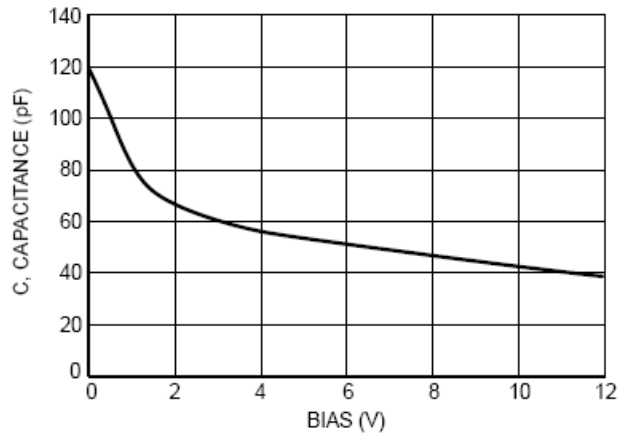

Figure 2. SD12 Typical Capacitance versus Bias Voltage

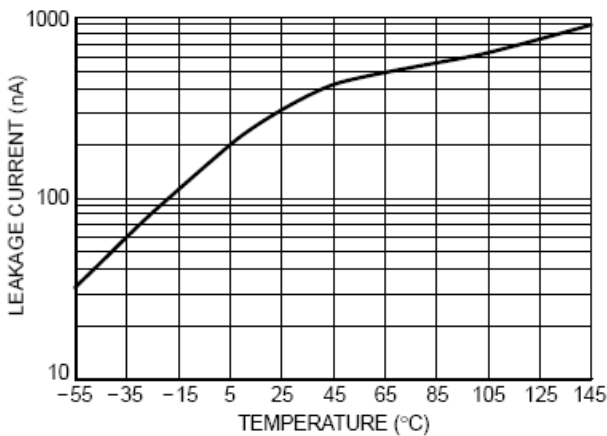

Figure 3. SD05 Typical Leakage Current versus Temperature

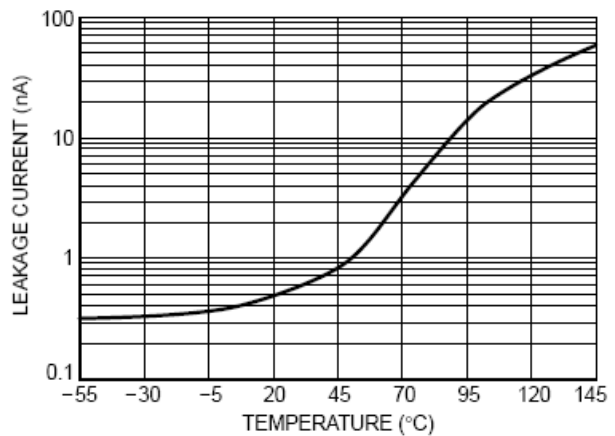

Figure 4. SD12 Typical Leakage Current versus Temperature

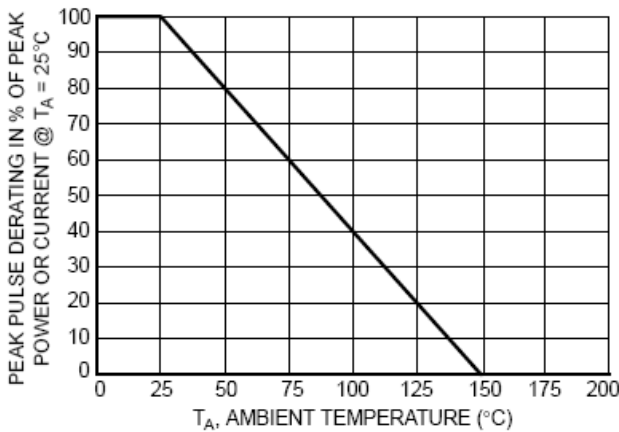

Figure 5. Pulse Derating Curve

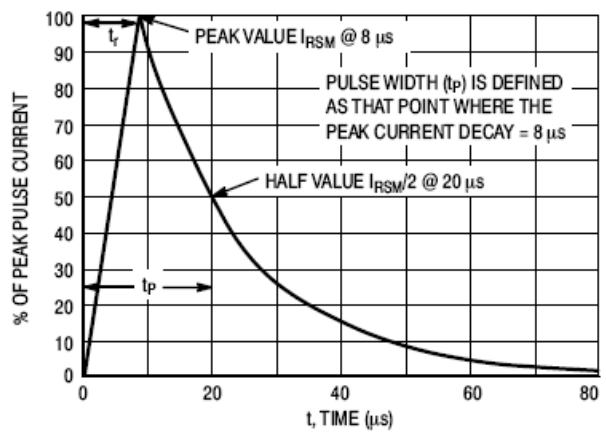

Figure 6. 8 x 20 μs Pulse Waveform



Micro Commercial Components

Ordering Information

Device	Packing
(Part Number)-TP	Tape&Reel;3Kpcs/Reel

*****IMPORTANT NOTICE*****

Micro Commercial Components Corp . reserves the right to make changes without further notice to any product herein to make corrections, modifications , enhancements , improvements , or other changes . *Micro Commercial Components Corp* . does not assume any liability arising out of the application or use of any product described herein; neither does it convey any license under its patent rights ,nor the rights of others . The user of products in such applications shall assume all risks of such use and will agree to hold *Micro Commercial Components Corp* . and all the companies whose products are represented on our website, harmless against all damages.

*****APPLICATIONS DISCLAIMER*****

Products offer by *Micro Commercial Components Corp* . are not intended for use in Medical, Aerospace or Military Applications.