



<b>Spec. No.</b>	PS-ND-0711
<b>Rev.</b>	A

# PRODUCT SPECIFICATION

**Model No : CSS-1014G/1015G**

Descriptions:
<ul style="list-style-type: none"> <li>• 1.0 Inch Single Digit Display</li> <li>• Emitting Color : Yellow Green</li> </ul>



CUSTOMER APPROVED SIGNATURES	APPROVED BY	CHECKED BY	PREPARED BY
			陳新強

**CHINA SEMICONDUCTOR CORPORATION**  
Address:2FL. NO.909,Chung-Cheng Road,  
Chung-Ho City Taipei Hsien,Taiwan.

Tel:886-2-2223-9696  
Fax:886-2-2223-9377

**OPTO PLUS TECHNOLOGIES CO.,LTD**  
Address:696 Shun jiang Rd.,Ji Shan St.Shaoxing,  
ZheJiang,China

Tel:86-0575-88623888  
Fax:86-0575-88623112



<b>Spec. No.</b>	PS-ND-0711
<b>Rev.</b>	A

**Model No : CSS-1014G/1015G**

**Features -**

1. 1.0 inch (25.4mm) digit height.
2. Case mold type.
3. RoHS compliant.
4. Low power consumption.
5. Easy mounting on P.C. board or socket.

**Device Selection Guide -**

Model No.	Chip		Description
	Material	Emitted Color	
<b>CSS-1014G</b>	<b>GaP</b>	<b>Yellow Green</b>	<b>Common Anode</b>
<b>CSS-1015G</b>	<b>GaP</b>	<b>Yellow Green</b>	<b>Common Cathode</b>

**Mechanical Dimensions -**

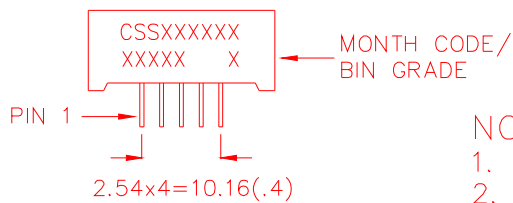
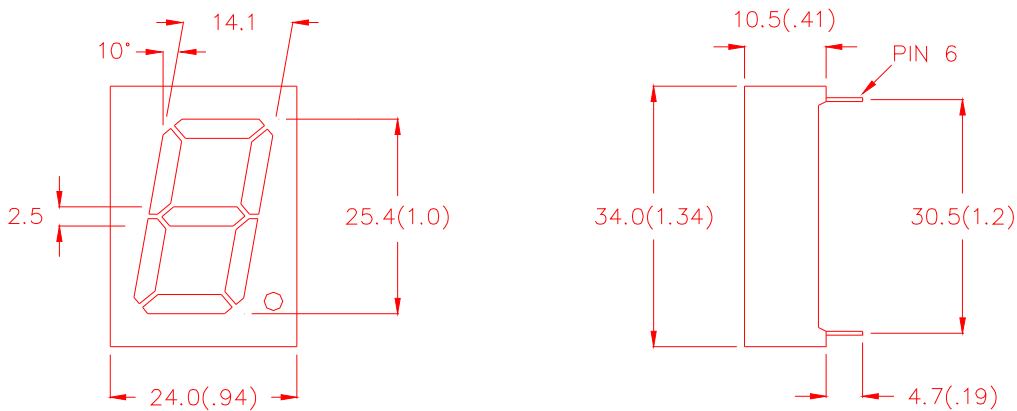

**NOTE:**

1. All pins are  $\phi 0.5(.02)$ .
2. Dimension in millimeter (inch), and tolerance is  $\pm 0.25 (.01)$  unless otherwise noted.



<b>Spec. No.</b>	PS-ND-0711
<b>Rev.</b>	A

**Model No : CSS-1014G/1015G**

**Internal Circuit Diagrams -**

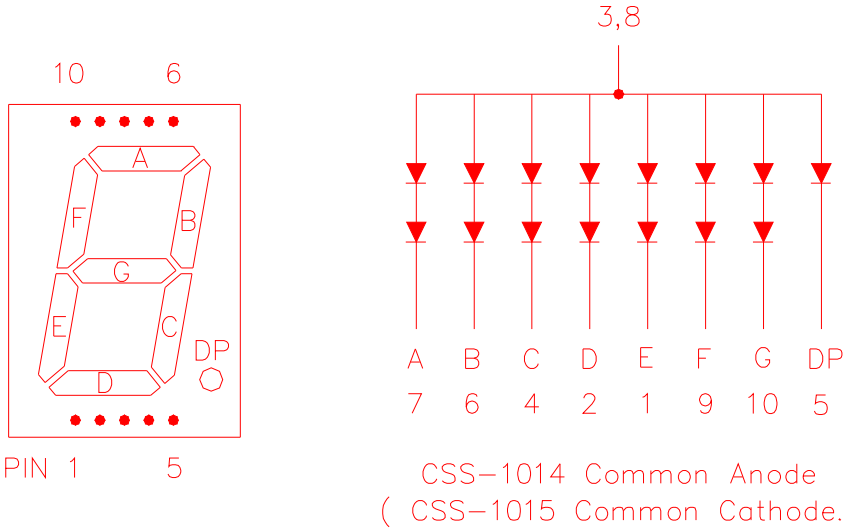

**Absolute Maximum Rating -**

(Ta=25°C)

Parameter	Symbol	Rating	Unit
Power Dissipation Per Dice	Pd	70	mW
Continuous Forward Current Per Dice	IAF	25	mA
Peak Current Per Dice	IPF	90	mA
Continuous Forward Current Per Dice	-	0.33	mA/°C
Reverse Voltage Per Dice	VR	5	V
Operating Temperature	Topr	-35 ~ +85	°C
Storage Temperature	Tstg	-35 ~ +85	°C
Solder temperature 1/16 inch below seating plane for 3 seconds at 260 °C			



Spec. No.	PS-ND-0711
Rev.	A

**Model No : CSS-1014G/1015G**
**Electro-optical Characteristics -**

(Ta=25°C)

Parameter	Symbol	Min.	Typ.	Max.	Unit	Condition
Forward Voltage Per Segment(DP)	V <sub>F</sub>	-	4.2(2.1)	5.6(2.8)	V	I <sub>F</sub> =20mA
Luminous Intensity Per Segment	I <sub>v</sub>	-	10	-	mcd	I <sub>F</sub> =10mA
Peak Emission Wavelength	λ <sub>P</sub>	-	568	-	nm	I <sub>F</sub> =20mA
Dominant Wavelength	λ <sub>d</sub>	-	572	-	nm	I <sub>F</sub> =20mA
Spectrum Radiation Bandwidth	Δλ	-	30	-	nm	I <sub>F</sub> =20mA
Reverse Current	I <sub>R</sub>	-	-	100	μA	V <sub>R</sub> =5V
Luminous Intensity Matching Ratio	I <sub>V-m</sub>	-	-	2:1	-	I <sub>F</sub> =20mA



Spec. No.	PS-ND-0711
Rev.	A

**Model No : CSS-1014G/1015G**

**Typical Electrical / Optical Characteristics Curves -**

(Ta = 25°C Unless Otherwise Noted)

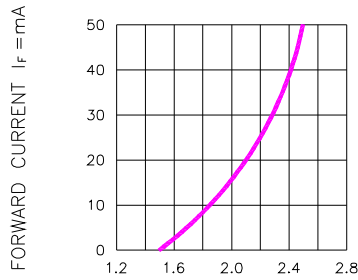

Fig.1 FORWARD CURRENT VS. FORWARD VOLTAGE

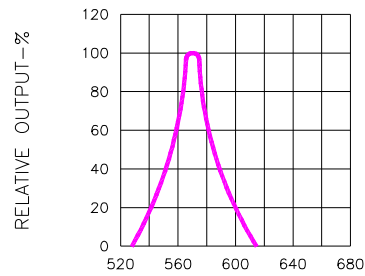

Fig.2 SPECTRAL RESPONSE

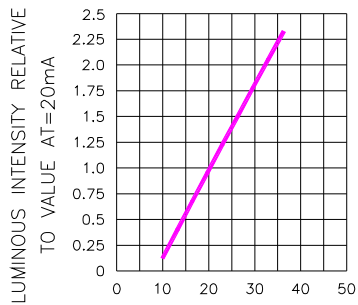

Fig.3 RELATIVE LUMINOUS INTENSITY VS. FORWARD CURRENT

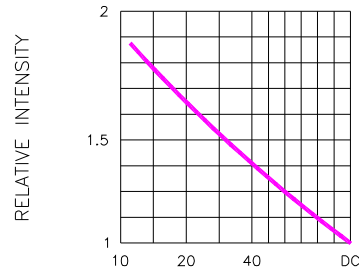

Fig.5 LUMINOUS INTENSITY VS. DUTY CYCLE

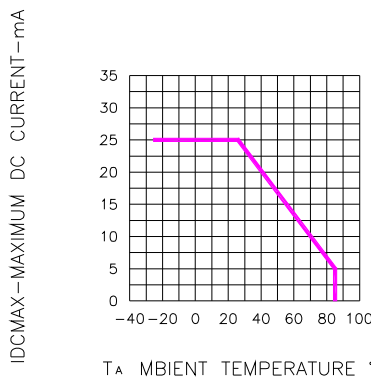

Fig.4 MAXIMUM ALLOWABLE DC CURRENT PER SEGMENT VS. A FUNCTION OF AMBIENT TEMPERATURE

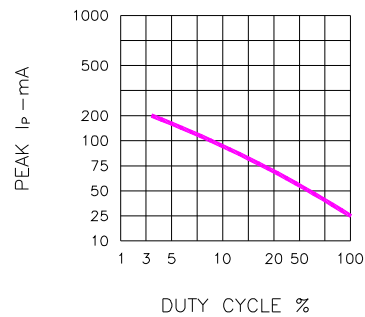

Fig.6 MAX PEAK CURRENT VS. DUTY CYCLE % (REFRESH RATE f = 1 KHz)



<b>Spec. No.</b>	PS-ND-0711
<b>Rev.</b>	A

**Model No : CSS-1014G/1015G**

**■ Package Dimensions**

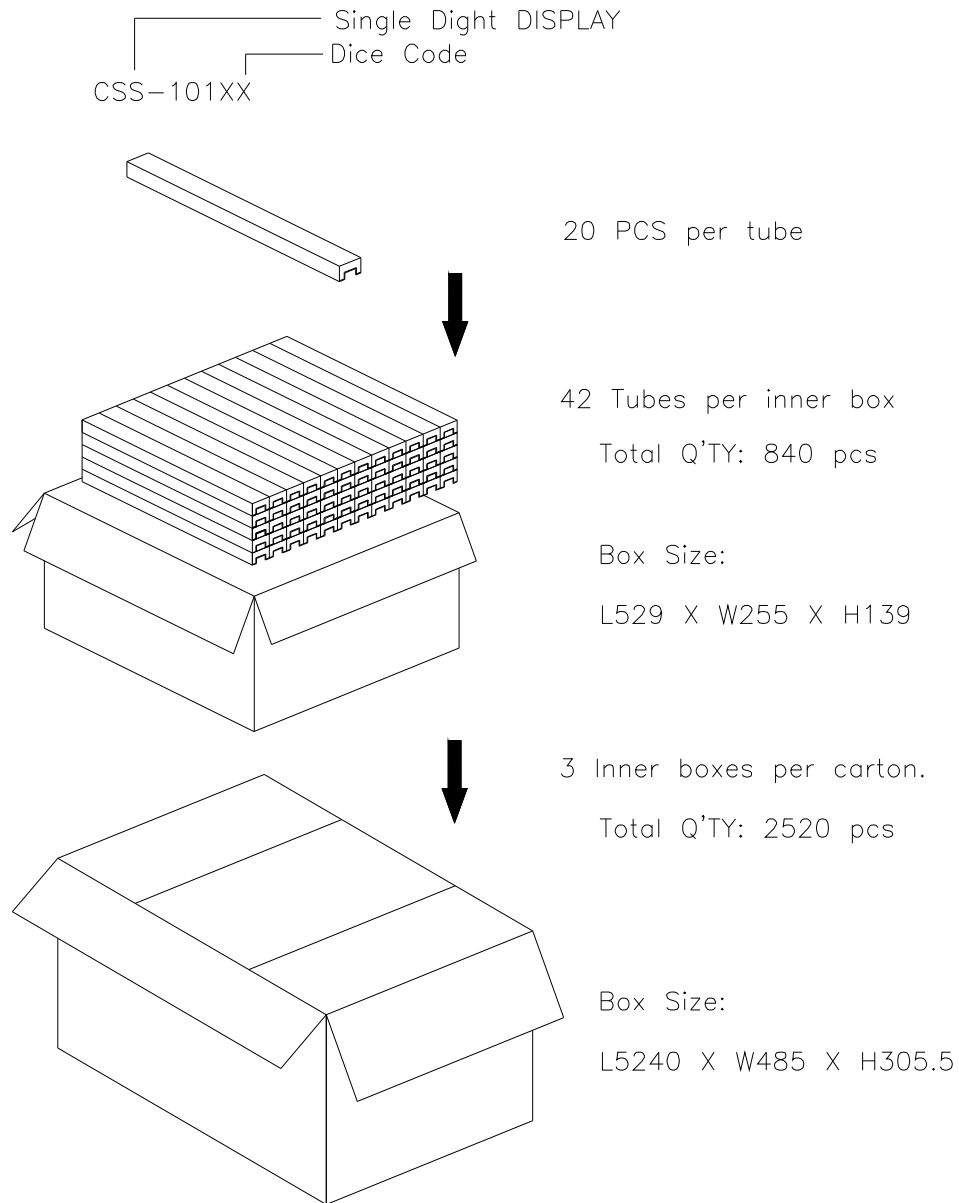

**Note: The specifications are subject to change without notice. Please contact us for updated information**  
<http://www.csctw.com.tw>