

NPN EPOXY - SWITCHING AND GENERAL PURPOSE (Cont'd.)

D

TYPE NO.	V _{CB}	V _{CE}	V _{EB}	h _{FE}	at	I _C	V _{CE}	V _{CE(s)} at I _B	I _C	f _T	C _{ob}	I _{CBO} at V _{CB}	CASE		
	V	V	V	min	max	mA	V	V	mA	mA	MHz	pF		μA	V
2N5136	30	20	3	20	400	150	1	.25	15	150	40	35	0.1	20	TO-105
2N5137	30	20	3	20	400	150	1	.25	15	150	40	35	0.1	20	TO-106
2N5172	25	25	5	100	500	10	10	.25	1	10	—	10	—	—	TO-98
2N5219	15	15	3	35	350	2	10	0.4	0.2	2	150	4	—	—	TO-92
2N5220	15	15	3	30	600	50	10	0.5	5	50	100	10	—	—	TO-92
2N5223	20	20	3	50	800	2	10	0.7	0.2	2	150	4	—	—	TO-92
2N5225	25	25	4	30	600	50	10	0.8	5	50	50	20	—	—	TO-92
2N5368	30	30	5	60	200	150	10	0.3	15	150	250	8	—	—	TO-92P
2N5369	30	30	5	100	300	150	10	0.3	15	150	250	8	—	—	TO-92P
2N5370	30	30	5	200	600	150	10	0.3	15	150	250	8	—	—	TO-92P
2N5371	30	30	5	60	600	150	10	0.3	15	150	250	8	—	—	TO-92P
2N5380	40	40	6	50	150	10	1	0.3	5	50	250	4	—	—	TO-92P
2N5381	40	40	6	100	300	10	1	0.3	5	50	300	4	—	—	TO-92P
2N5810	25	25	5	45	—	500	2	.75	50	500	100	15	—	—	TO-92P
2N5812	25	25	5	60	—	500	2	.75	50	500	135	15	—	—	TO-92P
2N5814	40	40	5	20	—	500	2	.75	50	500	100	15	—	—	TO-92P
2N5816	40	40	5	25	—	500	2	.75	50	500	120	15	—	—	TO-92P
2N5818	40	40	5	25	—	500	2	.75	50	500	135	15	—	—	TO-92P
2N5824	40	40	5	60	120	2	5	.125	1	10	—	4	—	—	TO-92P
2N5825	40	40	5	100	200	2	5	.125	1	10	—	4	—	—	TO-92P
2N5826	40	40	5	150	300	2	5	.125	1	10	—	4	—	—	TO-92P
2N5856	60	60	5	50	300	150	10	0.4	15	150	—	4	—	—	TO-105
2N5858	80	80	5	50	300	150	10	0.4	150	10	200	12	—	—	TO-105

NPN EPOXY - SATURATED SWITCH

TYPE NO.	V _{CB}	V _{CE}	V _{EB}	h _{FE}	at	I _C	V _{CE}	V _{CE(s)} at I _C	I _C	f _T	C _{ob}	t _{on}	t _{off}	I _{CBO} at V _{CB}	CASE	
	V	V	V	min	ma	mA	V	V	mA	MHz	pF	nS	nS	μA		V
2N3646	40	15	5	30	120	30	0.4	0.2	30	350	5	—	28	0.5	20	TO-106
2N4264	15	15	6	40	160	10	10	0.22	10	300	4	—	20	—	—	TO-92
2N4265	12	12	6	100	400	10	10	0.22	10	300	4	—	20	—	—	TO-92
2N4274	30	12	4	35	120	10	1	0.2	10	400	4	—	12	—	—	TO-106
2N4275	40	15	4	30	120	10	1	0.2	10	400	4	—	12	—	—	TO-106
2N5134	20	10	3	20	150	10	1	0.25	10	250	4	—	18	0.4	15	TO-106
2N5224	12	12	5	40	400	10	10	0.35	10	250	4	—	60	—	—	TO-92
2N5769	15	15	4	40	120	10	10	0.2	10	500	4	—	13	—	—	TO-92
2N5772	15	15	5	30	120	30	10	0.2	30	350	5	—	18	—	—	TO-92
2N5845	40	40	6	25	150	500	10	0.6	500	200	9	—	60	—	—	TO-92
2N5845A	40	40	6	35	150	500	10	0.5	500	250	9	—	50	—	—	TO-92

NPN EPOXY - LOW NOISE LEVEL AMPLIFIER

TYPE NO.	V _{CB}	V _{CE}	V _{EB}	h _{FE}	at	I _C	V _{CE}	V _{CE(s)} at I _C	I _C	f _T	C _{ob}	NF	t _{off}	I _{CBO} at V _{CB}	CASE	
	V	V	V	min	max	mA	V	V	mA	MHz	pF	dB	nS	μA		V
2N3391	25	25	5	250	500	2.0	4.5	—	—	—	10	—	—	—	—	TO-98
2N3391A	25	25	5	250	500	2.0	4.5	—	—	—	10	5.0	—	—	—	TO-98
2N3565	30	25	6	150	600	1.0	10	—	—	40	4.0	—	—	.05	25	TO-106
2N3691	35	20	4	40	160	10	1.0	0.7	10	200	3.5	—	—	.05	15	TO-106
2N3692	35	20	4	100	400	10	1.0	0.7	10	200	3.5	—	—	.05	15	TO-106
2N3900	18	18	5	250	500	2.0	4.5	—	—	—	12	—	—	—	—	TO-98
2N3900A	18	18	5	250	500	2.0	4.5	—	—	—	12	5.0	—	—	—	TO-98
2N4966	50	40	6	40	200	.01	5	0.4	—	40	6	6	—	.025	25	TO-106
2N4967	50	40	6	100	600	.01	5	0.4	—	40	6	6	—	.025	25	TO-106
2N4968	30	25	6	40	200	.01	5	0.4	—	40	6	6	—	.05	25	TO-106

CASE OUTLINE DRAWINGS

D

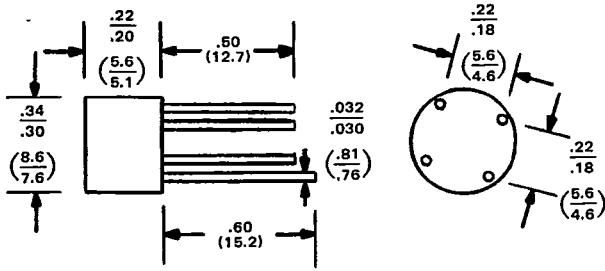

CASE A

CBR1 Series
CBR2 Series

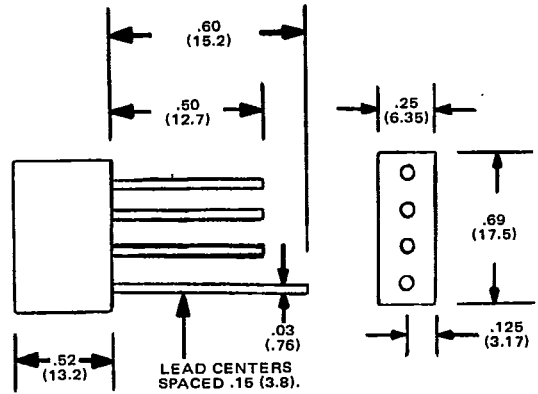

CASE B

CBR1-L Series
CBR2-L Series

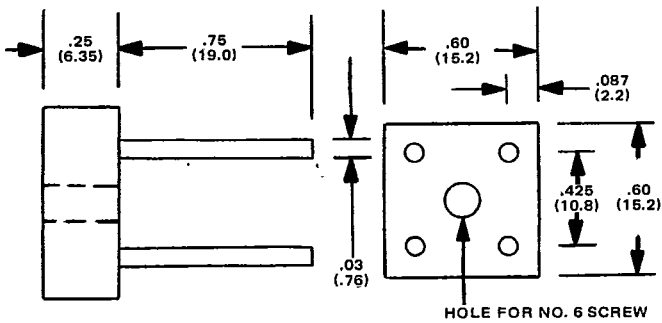

CASE C

CBR3-P Series

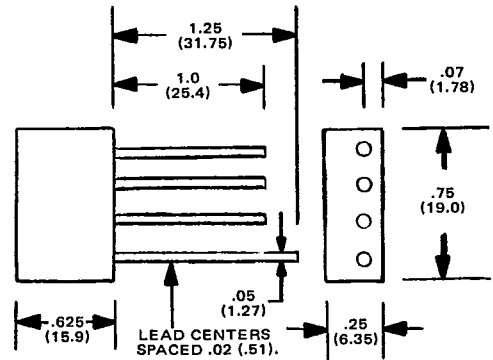

CASE D

CBR4-L Series

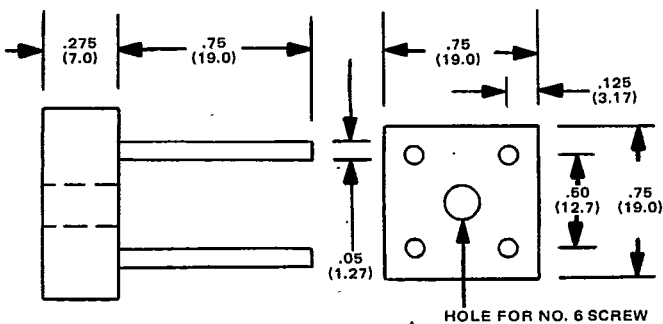

CASE E

CBR8 Series

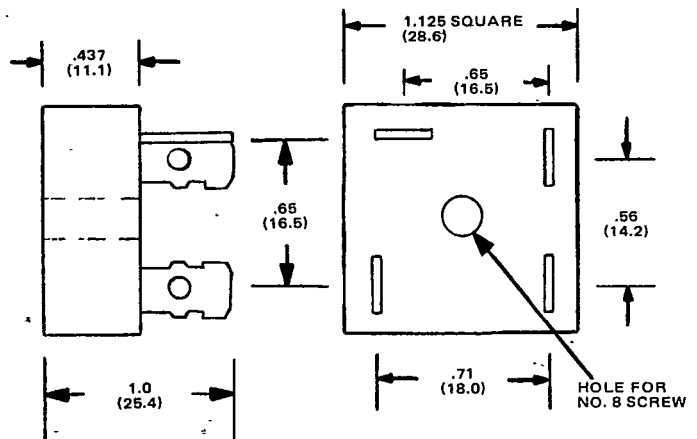

CASE F

CBR10 Series, CBR25 Series
CBR12 Series, CBR30 Series

All Dimensions in Inches (Millimeters)

Drawings Not To Scale

TO-5

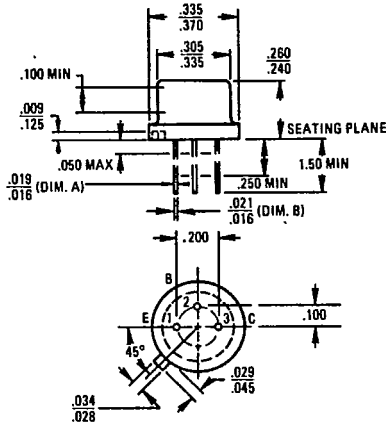

TO-18

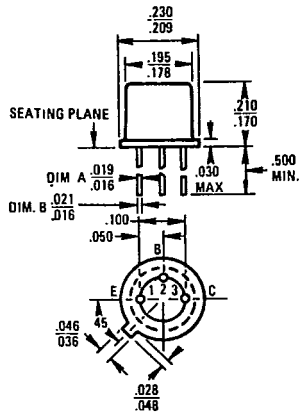

TO-39

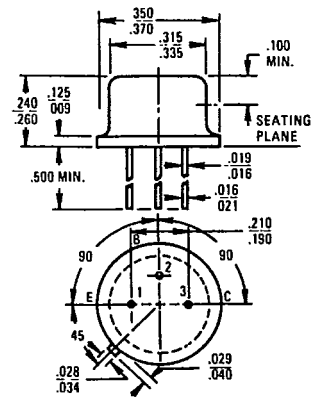

TO-46

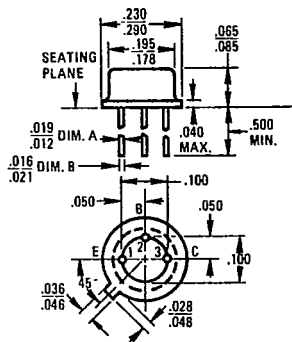

TO-72

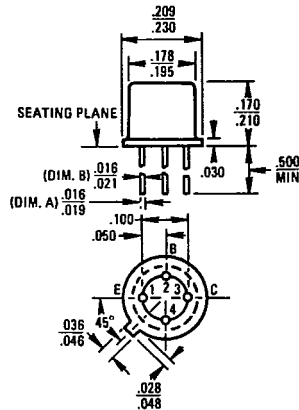

TO-92

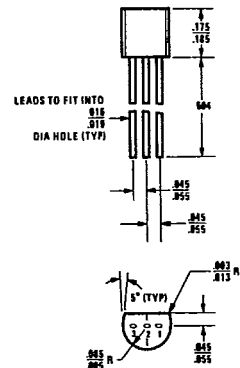

TO-98

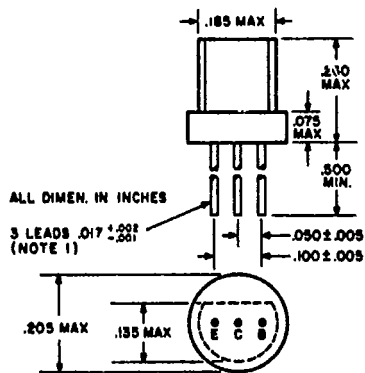

TO-105

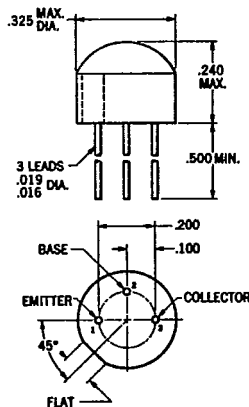

TO-106

