

## High Performance Schottky Generation 5.0, 20 A

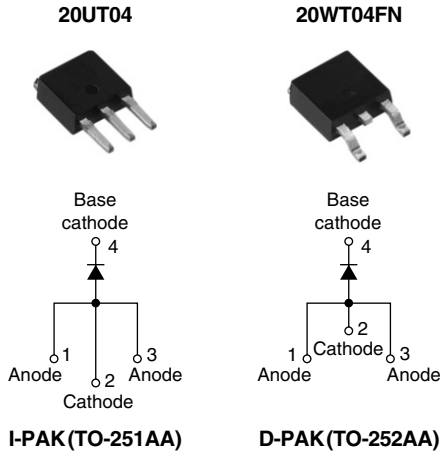

### FEATURES

- 175 °C high performance Schottky diode
- Very low forward voltage drop
- Extremely low reverse leakage
- Optimized  $V_F$  vs.  $I_R$  trade off for high efficiency
- Increased ruggedness for reverse avalanche capability
- RBSOA available
- Negligible switching losses
- Submicron trench technology
- Full lead (Pb)-free and RoHS compliant devices
- Qualified for AEC Q101



**RoHS**  
COMPLIANT

### APPLICATIONS

- Specific for PV cells bypass diode
- High efficiency SMPS
- Automotive
- High frequency switching
- Output rectification
- Reverse battery protection
- Freewheeling
- Dc-to-dc systems
- Increased power density systems

PRODUCT SUMMARY	
$I_{F(AV)}$	20 A
$V_{RRM}$	45 V
Maximum $V_F$ at 20 A at 125 °C <sup>(1)</sup>	0.530 V

**Note**

<sup>(1)</sup> Measured connecting 2 anode pins

[www.DataSheet4U.com](http://www.DataSheet4U.com)

MAJOR RATINGS AND CHARACTERISTICS			
SYMBOL	CHARACTERISTICS	VALUES	UNITS
$V_{RRM}$		45	V
$V_F$	20 Apk, $T_J = 125\text{ °C}$ (typical, measured connecting 2 anode pins)	0.480	V
$T_J$	Range	- 55 to 175	°C

VOLTAGE RATINGS				
PARAMETER	SYMBOL	TEST CONDITIONS	20UT04 20WT04FN	UNITS
Maximum DC reverse voltage	$V_R$	$T_J = 25\text{ °C}$	45	V

ABSOLUTE MAXIMUM RATINGS					
PARAMETER	SYMBOL	TEST CONDITIONS		VALUES	UNITS
Maximum average forward current	$I_{F(AV)}$	50 % duty cycle at $T_C = 153\text{ }^\circ\text{C}$ , rectangular waveform		20	A
Maximum peak one cycle non-repetitive surge current	$I_{FSM}$	5 $\mu\text{s}$ sine or 3 $\mu\text{s}$ rect. pulse	Following any rated load condition and with rated $V_{RRM}$ applied <sup>(1)</sup>	900	A
		10 ms sine or 6 ms rect. pulse		220	
Non-repetitive avalanche energy	$E_{AS}$	$T_J = 25\text{ }^\circ\text{C}$ , $I_{AS} = 7\text{ A}$ , $L = 4.4\text{ mH}$		108	mJ
Repetitive avalanche current	$I_{AR}$	Limited by frequency of operation and time pulse duration so that $T_J < T_J\text{ max.}$ $I_{AS}$ at $T_J\text{ max.}$ as a function of time pulse		$I_{AS}$ at $T_J\text{ max.}$	A

**Note**

(1) Measured connecting 2 anode pins

ELECTRICAL SPECIFICATIONS						
PARAMETER	SYMBOL	TEST CONDITIONS		TYP.	MAX.	UNITS
Forward voltage drop	$V_{FM}$ <sup>(1,2)</sup>	10 A	$T_J = 25\text{ }^\circ\text{C}$	0.505	0.540	V
		20 A		0.570	0.610	
		10 A	$T_J = 125\text{ }^\circ\text{C}$	0.415	0.450	
		20 A		0.520	0.580	
Reverse leakage current	$I_{RM}$ <sup>(1)</sup>	$T_J = 25\text{ }^\circ\text{C}$	$V_R = \text{Rated } V_R$	-	100	$\mu\text{A}$
		$T_J = 125\text{ }^\circ\text{C}$		-	7	mA
Junction capacitance	$C_T$	$V_R = 5\text{ }V_{DC}$ (test signal range 100 kHz to 1 MHz), $25\text{ }^\circ\text{C}$		1900	-	pF
Series inductance	$L_S$	Measured lead to lead 5 mm from package body		-	-	nH
Maximum voltage rate of change	$dV/dt$	Rated $V_R$		-	10 000	V/ $\mu\text{s}$

**Notes**(1) Pulse width < 300  $\mu\text{s}$ , duty cycle < 2 %

(2) Only 1 anode pin connected

THERMAL - MECHANICAL SPECIFICATIONS					
PARAMETER	SYMBOL	TEST CONDITIONS		VALUES	UNITS
Maximum junction and storage temperature range	$T_J, T_{Stg}$			- 55 to 175	$^\circ\text{C}$
Maximum thermal resistance, junction to case	$R_{thJC}$	DC operation		1.2	$^\circ\text{C/W}$
Typical thermal resistance, case to heatsink	$R_{thCS}$			0.3	
Approximate weight				2	g
				0.07	oz.
Marking device		Case style I-PAK		20UT04	
		Case style D-PAK		20WT04FN	



High Performance  
Schottky Generation 5.0, 20 A

Vishay High Power Products

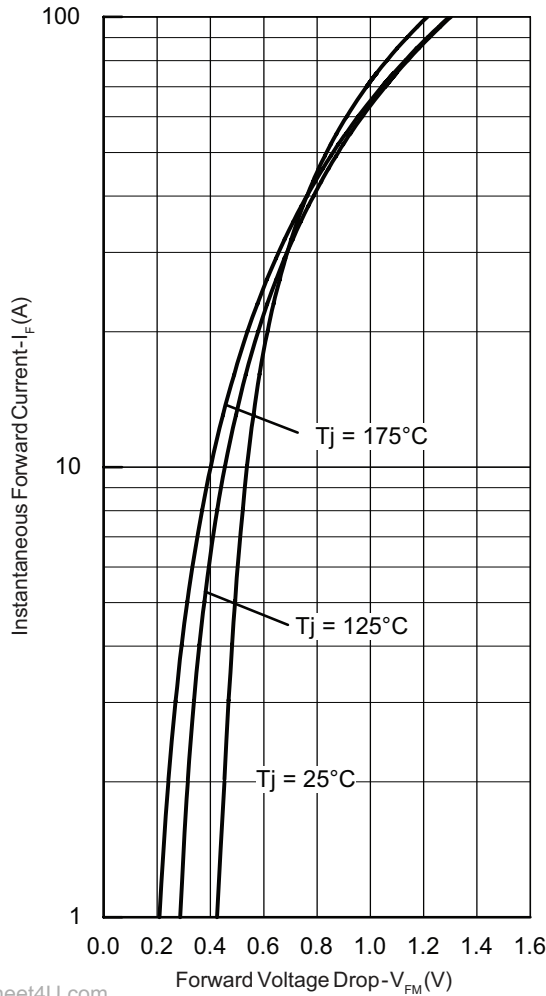

Fig. 1 - Maximum Forward Voltage Drop Characteristics

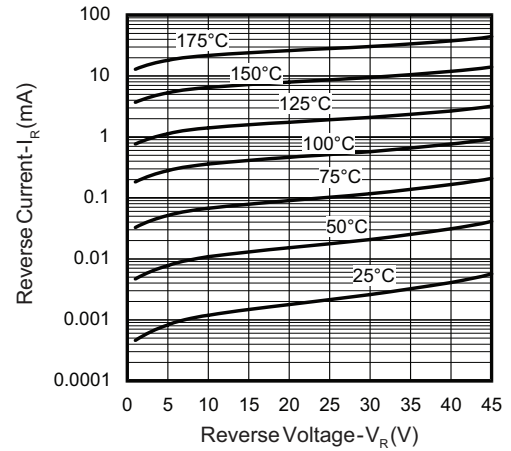

Fig. 2 - Typical Values of Reverse Current vs. Reverse Voltage

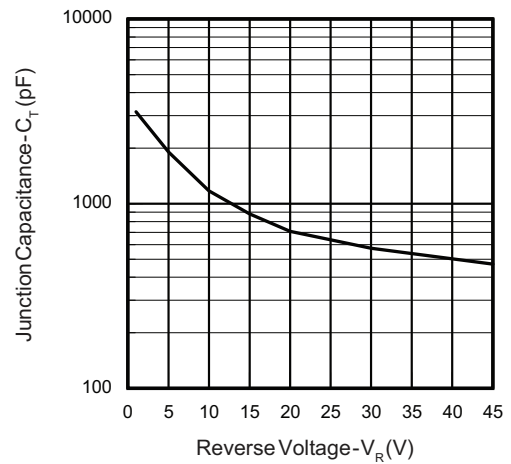

Fig. 3 - Typical Junction Capacitance vs. Reverse Voltage

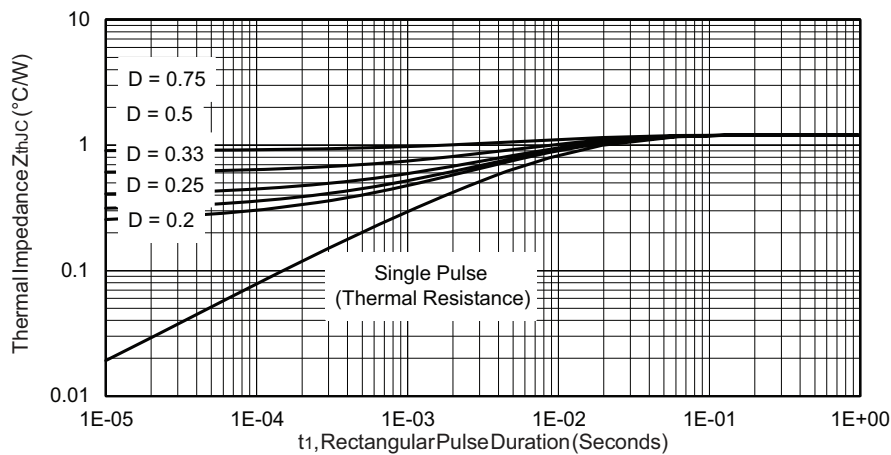

Fig. 4 - Maximum Thermal Impedance  $Z_{thJC}$  Characteristics

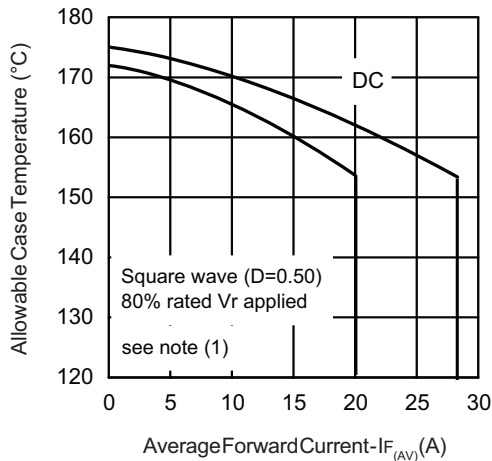

Fig. 5 - Maximum Allowable Case Temperature vs. Average Forward Current

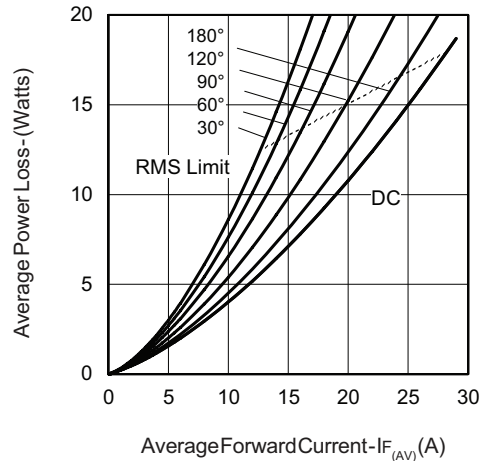

Fig. 6 - Forward Power Loss Characteristics

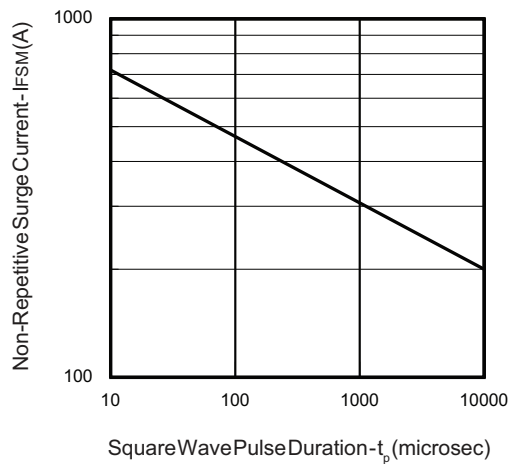

Fig. 7 - Maximum Non-Repetitive Surge Current

www.DataSheet4U.com

**Note**

- (1) Formula used:  $T_C = T_J - (P_d + P_{d_{REV}}) \times R_{thJC}$ ;  
 $P_d$  = Forward power loss =  $I_{F(AV)} \times V_{FM}$  at  $(I_{F(AV)}/D)$  (see fig. 6);  
 $P_{d_{REV}}$  = Inverse power loss =  $V_{R1} \times I_R (1 - D)$ ;  $I_R$  at  $V_{R1} = 80\%$  rated  $V_R$



High Performance Vishay High Power Products  
Schottky Generation 5.0, 20 A

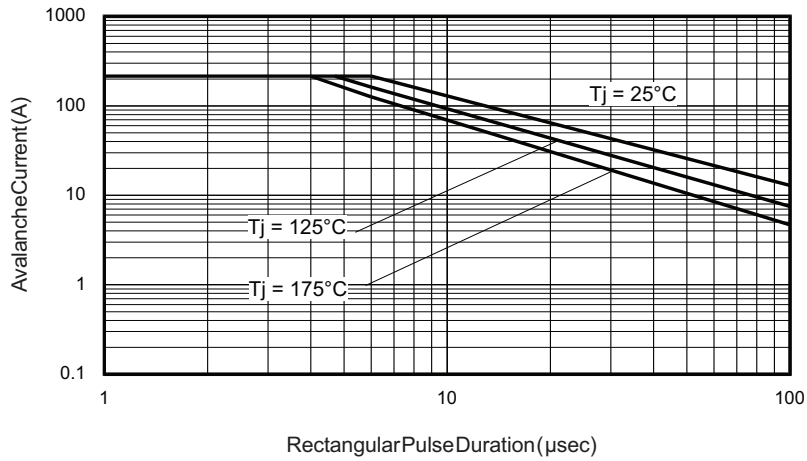

Fig. 8 - Reverse Bias Safe Operating Area (Avalanche Current vs. Rectangular Pulse Duration)

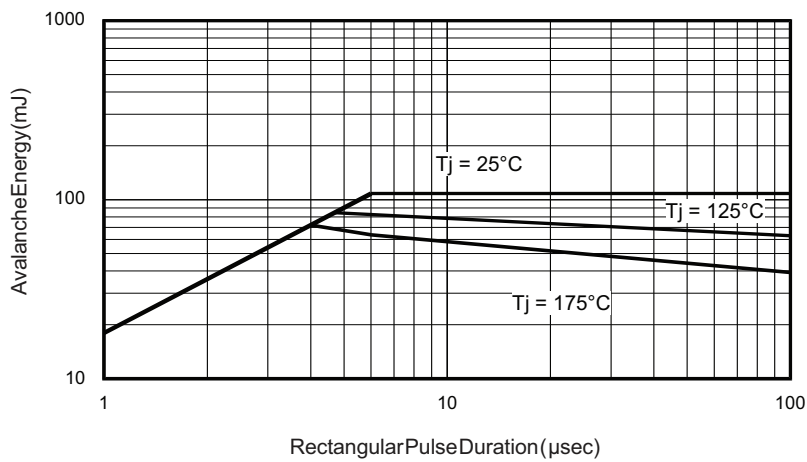
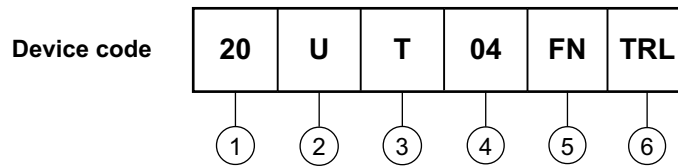

Fig. 9 - Reverse Bias Safe Operating Area (Avalanche Energy vs. Rectangular Pulse Duration)

[www.DataSheet4U.com](http://www.DataSheet4U.com)

## ORDERING INFORMATION TABLE



- 1** - Current rating (20 A)
- 2** - Package:
  - U = I-PAK
  - W = D-PAK
- 3** - T = Trench
- 4** - Voltage code (45 V)
- 5** - TO-252AA (D-PAK)
- 6** - D-PAK, I-PAK: None = Tube (75 pieces)  
D-PAK only:
  - TR = Tape and reel
  - TRL = Tape and reel (left oriented)
  - TRR = Tape and reel (right oriented)

LINKS TO RELATED DOCUMENTS	
Dimensions	<a href="http://www.vishay.com/doc?95024">http://www.vishay.com/doc?95024</a>
Part marking information	<a href="http://www.vishay.com/doc?95025">http://www.vishay.com/doc?95025</a>
Packaging information	<a href="http://www.vishay.com/doc?95033">http://www.vishay.com/doc?95033</a>
SPICE model	<a href="http://www.vishay.com/doc?95027">http://www.vishay.com/doc?95027</a>



## Disclaimer

All product specifications and data are subject to change without notice.

Vishay Intertechnology, Inc., its affiliates, agents, and employees, and all persons acting on its or their behalf (collectively, "Vishay"), disclaim any and all liability for any errors, inaccuracies or incompleteness contained herein or in any other disclosure relating to any product.

Vishay disclaims any and all liability arising out of the use or application of any product described herein or of any information provided herein to the maximum extent permitted by law. The product specifications do not expand or otherwise modify Vishay's terms and conditions of purchase, including but not limited to the warranty expressed therein, which apply to these products.

No license, express or implied, by estoppel or otherwise, to any intellectual property rights is granted by this document or by any conduct of Vishay.

The products shown herein are not designed for use in medical, life-saving, or life-sustaining applications unless otherwise expressly indicated. Customers using or selling Vishay products not expressly indicated for use in such applications do so entirely at their own risk and agree to fully indemnify Vishay for any damages arising or resulting from such use or sale. Please contact authorized Vishay personnel to obtain written terms and conditions regarding products designed for such applications.

Product names and markings noted herein may be trademarks of their respective owners.