

cosmo**High Reliability Photocoupler KTLP165J**

UL 1577 (File No.E169586) VDE EN60747-5-2 (File No.40009235)

Features

1. Opaque type, mini-flat package.
2. Subminiature type
(The volume is smaller than that of our conventional DIP type by as far as 30%)
3. Isolation voltage between input and output (Viso:2500Vrms).

For 115/240 Vac (rms) Application:

1. Solenoid/Valve Controls.
2. Lighting Controls.
3. Static Power Switches.
4. AC Motor Drives.
5. Temperature Controls.
6. E.M. Contactors.
7. AC Motor Staters.
8. Solid State Relays.
9. Programmable controllers.

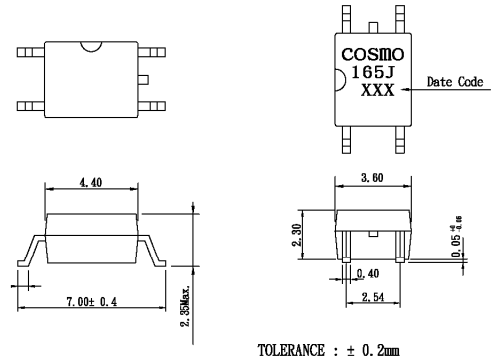
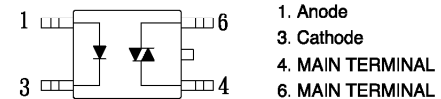
**Schematic:Top View****Absolute Maximum Ratings**

(Ta=25°C)

	Parameter	Symbol	Rating	Unit
Input	Forward current	IF	50	mA
	Peak forward current (100us)	IFM	1	A
	Reverse voltage	VR	6	V
	Power dissipation	PD	70	mW
Output	Off-State Output Terminal voltage	VDRM	600	Vpeak
	On-State R. M. S. Current	IT(RMS)	70	mA
	Peak Repetitive Surget Current (PW=10ms, DC 10%)	ITSM	1	A
	Power dissipation	PD	150	mW
	Total power dissipation	Ptot	200	mW
	Isolation voltage 1 minute	Viso	2500	Vrms
	Operating temperature	Topr	-40 to +100	°C
	Storage temperature	Tstg	-50 to +125	°C
	Soldering temperature 10 second	Tsol	260	°C

Electro-optical Characteristics

(Ta=25°C)

	Parameter	Symbol	Conditions	MIN.	TYP.	MAX.	Unit
Input	Forward voltage	VF	IF=10mA	—	1.2	1.4	V
	Peak forward voltage	VFM	IFM=0.5A	—	—	3.5	V
	Reverse Leakage Current	IR	VR=5V	—	—	10	μA
Output	Peak Blocking Current	IDRM	VDRM=600V	—	—	1.0	μA
	ON-State Voltage	VTM	ITM=70mA	—	1.6	2.8	V
Transfer characteristics	Holding Current	IH		—	1.0	—	mA
	Critical rate of rise of OFF-state voltage	dV/dt	VDRM= (1/ J2) *Rated	600	—	—	V/μS
	Isolation resistance	Riso	DC500V	5x10 ¹⁰	10 ¹¹	—	ohm
	Minimum trigger current	IFT	Main Terminal Voltage=3V	—	5	10	mA
	Turn-on time	Ton	VD=6V, RL=100 ohm, IF=20mA	—	—	100	μS

Classification table of Trigger LED current is shown below.

(Ta=25°C)

Classification	Trigger LED Current (mA)	
	Min.	Max.
1 (Standard)	-	10
2	-	7
3	-	5

Fig.1 Forward Current vs. Ambient Temperature

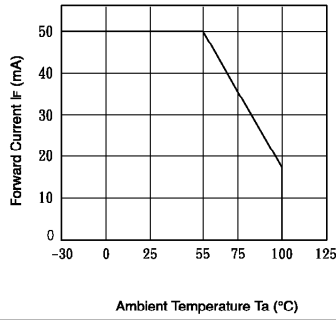

Fig.2 Diode Power Dissipation vs. Ambient Temperature

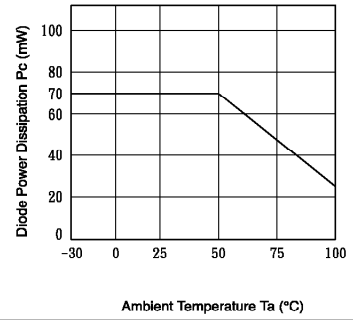

Fig.3 On-State R. M. S. Current vs. Ambient Temperature

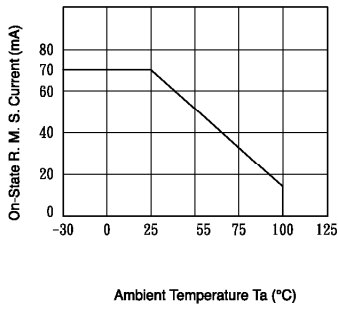

Fig.4 Total Power Dissipation vs. Ambient Temperature

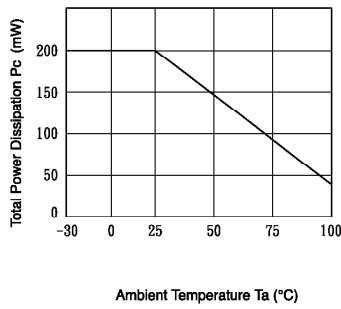

Fig.5 Peak Forward Current vs. Duty Ratio

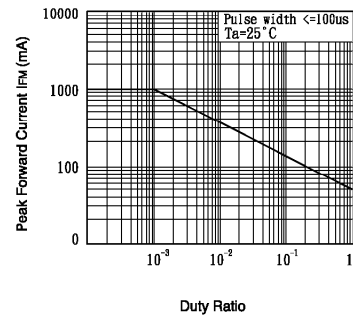

Fig.6 Forward Current vs. Forward Voltage

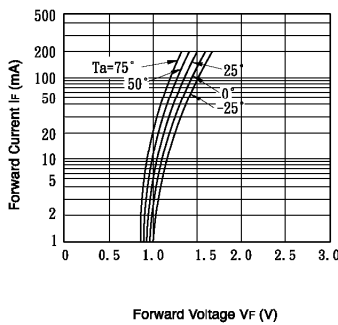

Fig.7 On-State Characteristics

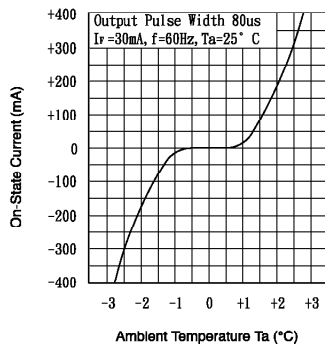

Fig.8 Leakage with LED off vs. Ambient Temperature

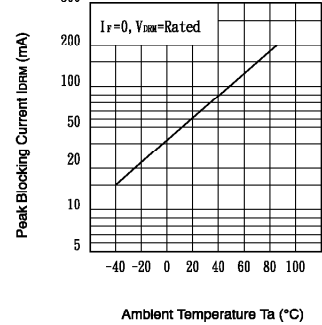

Fig.9 Trigger Current vs. Ambient Temperature

