

HG62G Series

High-Speed CMOS Gate Array



Sep. 1991
Rev. 0

Description

The HG62G series free-channel gate arrays are fabricated with 0.8 μm CMOS process and double metal interconnect technology. The HG62G series consists of 4 master slices ranging from 14,540 to 34,797 raw gates with high I/O pin counts.

Internal gate delay time is as low as 0.3 ns per gate and output buffer speed is improved as 1.8 ns with maximum drivability of 24 mA output current.

The macro cells are compatible with the HG62S series, including RAM availability.

With the HG62G, it is easy to design high-speed, high-performance systems with on-chip autodiagnosis support.

Features

- Ultrahigh-speed operation
 - Internal gate (2-input power NAND, FO = 2, AI = 2 mm).....0.3 ns typ.
 - Input buffer (FO = 2, AI = 2 mm).....0.8 ns typ.
 - Output buffer ($C_L = 50$ pF).....1.8 ns typ.
- High drivability output
 - Selective buffers with $I_{OL} = 2$ mA, 8 mA, 12 mA or 24 mA
- High I/O pin counts
 - Around 40% improvement in a comparison with current HG62S series.
- Low power dissipation
 - Internal gate at 10 MHz operation90 $\mu\text{w/gate}$ typ.
- Autodiagnosis
 - Automatic test circuit and test pattern generation
- RAM capability
 - Various single-/dual-port RAMS
 - Built-in autodiagnosis function
- Macro cell library variation
 - Compatibility with HG62S series
 - Power-type cell variation
 - Normal or scan type latches and flip-flops available
- Wide variety of input and output cells
 - Input, output and I/O buffers
 - TTL or CMOS levels
 - Reduced noise output buffers
 - Driving capacity: $I_{OL} = 2, 8, 12, 24$ mA
 - Oscillator, Schmitt-trigger inputs, pull-up/down resistors
- Package variety: High pin count packages
- Design support environment
 - Hierarchical design support
 - Fault simulator for test pattern evaluation
 - Automatic test pattern
 - Local design support center
 - EWS (engineering work station) support

Ordering Information

Item	HG62G014	HG62G019	HG62G027	HG62G035
Gate count	14,540	19,519	27,587	34,797
Pad count	160	184	216	240



/

HG62G Series

Maximum Available Signal Pins

Package Type	Body	HG62G014	HG62G019	HG62G027	HG62G035
DILP-64S		(under dev)	(under dev)	—	—
QFP-64	14 × 14 mm	(under dev)	(under dev)	(under dev)	—
QFP-80	14 × 14 mm	(under dev)	(under dev)	(under dev)	(under dev)
QFP-100	14 × 14 mm	(under dev)	(under dev)	(under dev)	(under dev)
QFP-144	20 × 20 mm	(under dev)	(under dev)	(under dev)	(under dev)
QFP-176	24 × 24 mm	(under dev)	(under dev)	(under dev)	(under dev)
QFP-136	28 × 28 mm	128	(under dev)	(under dev)	(under dev)
QFP-168	28 × 28 mm	136	152	152	(under dev)
QFP-208	28 × 28 mm			188	188

Note: (under dev): Under development

Logic Design Cautions

Number of Usable Gates

In free-channel gate arrays, a routing area is kept open by spoiling some of the basic cells in the channel area used. Therefore, the actual gate count depends on the logic circuit. Table 3 shows approximate gate counts.

If RAM is used, Hitachi needs to know the memory density (word/bit organization) and random logic gate counts to quote the best master slice selection.

Autodiagnosis

Automatic generation of high fault coverage (more than 95%) test circuits and test patterns requires the following:

- Dedicate two pins to test functions (figure 1).
- Use cells with scan function for latches, flip-flops, and shift registers. Calculations for timing design and gate count estimation should use macro cells with the scan function. The names of macro cells with the scan function start with "T". For example, FD (normal) → TFD (scan type).

Approximate Actual Gate Counts

Master	HG62G014	HG62G019	HG62G027	HG62G035
Usable gates (k gates)	5.8–6.5	7.8–8.8	11.0–12.4	13.9–15.7

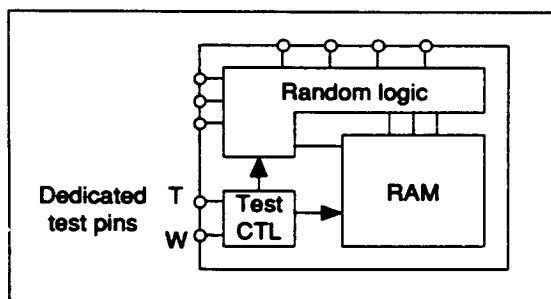

Figure 1 Autodiagnostic Pins

- Autodiagnosis is also available for circuits with RAM, and the RAM itself can be autodiagnosed. Even when autodiagnosis is not required for RAM but only for the peripheral circuits, use RAM cells with the scan function.

$$t_{plh} = t_{olh} + (K_{lh} \times C_L)$$

$$t_{phl} = t_{ohl} + (K_{hl} \times C_L)$$

$$C_L = \Sigma C_{AL} + 0.05 \times \Sigma LV$$

Where:

C_{AL} : Statistic wiring capacitance per fanout
 LV: Input load constant

Blocks

Logically unified circuits can be placed in a block during layout. The maximum number of gates in a block should be 4,000. Also, the total number of gates in all blocks should be less than 60% of the total number of gates.

The macro cell library lists the t_o , K, and LV constants.

Gate Delay Time

Gate delay time calculations are more accurate when they use actual routing information after automatic layout. However, a rough estimation is needed to prevent timing design errors in the earlier design phase. Gate delay times are estimated as follows:

In delay time calculations, the statistic wiring capacitance per fanout depends on whether the circuits are part of a block layout (table 1).

Table 1 Statistic Wiring Capacitance

	Unit : (pF/fo)		
	Inter-block		
	Intra-block	G014, G019	G027, S035
C_{AL}	0.12	0.25	0.35

Note: Gate delay time distribution: 35%–180%
 $V_{CC} = 5\text{ V} \pm 5\%$, $T_a = -20^\circ\text{C}$ to $+75^\circ\text{C}$

Macro Cell Library

I/O Buffers

- Input buffers

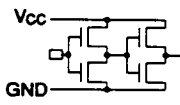
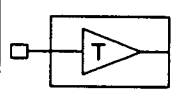
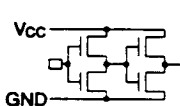
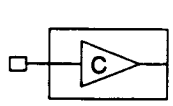
Macro		Equiv. Circuit	Equiv. Gate Count	LV	Clamp Level when Open	Symbol	Symbol No.	Delay				
								Input Name	Output Name	t_{plh} (ns)		t_{phl} (ns)
Function and Macro Name							t_{olh}			K_{lh}	t_{ohl}	K_{hl}
TTL-level input buffer IT		—	—			D1			0.53	0.16	1.19	0.14
CMOS-level input buffer IC		—	—			D1			0.65	0.17	0.82	0.14

Note) When using EWS for gate array design, please reconfirm the latest availability of cells.

HG62G Series

• Input buffers (cont)

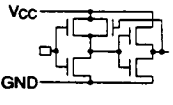
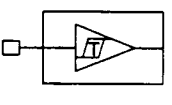
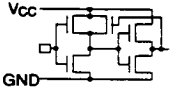
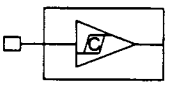
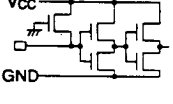
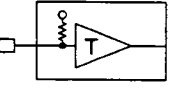
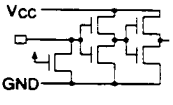
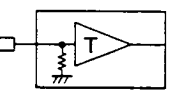
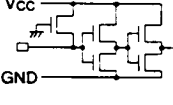
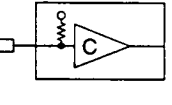
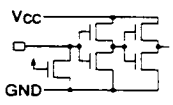
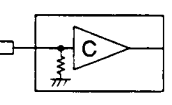
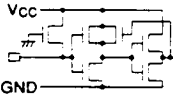
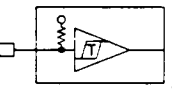
Macro Function and Macro Name	Equiv. Circuit	Equiv. Gate Count	LV	Clamp Level when Open	Symbol	Sym- bol No.	In- put Name	Out- put Name	Delay			
									t_{plh} (ns)		t_{phl} (ns)	
									t_{olh}	K_{lh}	t_{ohl}	K_{hl}
Schmitt- trigger TTL-level input buffer ITS		—	—			D1			0.83	0.22	1.57	0.27
Schmitt- trigger CMOS- level input buffer ICS		—	—			D1			0.96	0.26	1.34	0.26
TTL-level input buffer with pull-up ITU		—	—			D2			0.53	0.16	1.19	0.14
TTL-level input buffer with pull-down ITD		—	—			D2			0.53	0.16	1.19	0.14
CMOS- level input buffer with pull-up ICU		—	—			D2			0.65	0.17	0.82	0.14
CMOS- level input buffer with pull-down ICD		—	—			D2			0.65	0.17	0.82	0.14
Schmitt- trigger TTL-level input buffer with pull-up ITSU		—	—			D2			0.83	0.22	1.57	0.27

• Input buffers (cont)

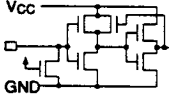
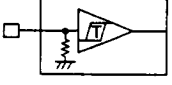
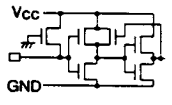
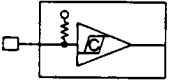
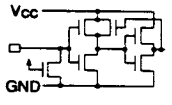
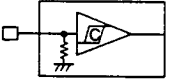
Macro			LV	Clamp Level when Open	Symbol	Sym- bol No.	In- put Name	Out- put Name	Delay			
Function and Macro Name	Equiv. Circuit	Equiv. Gate Count							t_{plh} (ns)		t_{phi} (ns)	
									t_{olh}	K_{lh}	t_{ohl}	K_{hl}
Schmitt-trigger TTL-level input buffer with pull-down ITSD		—	—			D2			0.83	0.22	1.57	0.27
Schmitt-trigger CMOS-level input buffer with pull-up ICSU		—	—			D2			0.96	0.26	1.34	0.26
Schmitt-trigger CMOS-level input buffer with pull-down ICSD		—	—			D2			0.96	0.26	1.34	0.26

• Crystal oscillators

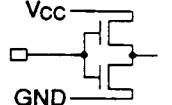
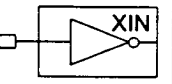
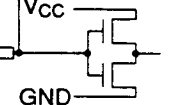
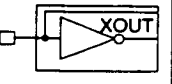
Macro			LV	Clamp Level when Open	Symbol	Sym- bol No.	In- put Name	Out- put Name	Delay			
Function and Macro Name	Equiv. Circuit	Equiv. Gate Count							t_{plh} (ns)		t_{phi} (ns)	
									t_{olh}	K_{lh}	t_{ohl}	K_{hl}
OSC in (2 M to 20 MHz) XIN		—	—			D1			2.40	0.19	1.80	0.11
OSC out (2 M to 20 MHz) XOUT		—	—			D1			0.96	0.12	0.66	0.13

HG62G Series

• Crystal oscillators (cont)

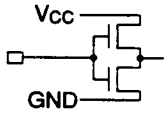
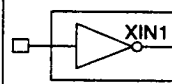
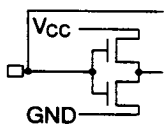
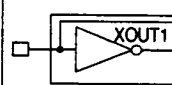
Macro			LV	Clamp Level when Open	Symbol	Symbol No.	Input Name	Output Name	Delay			
Function and Macro Name	Equiv. Circuit	Equiv. Gate Count							t_{plh} (ns)		t_{phl} (ns)	
									t_{olh}	K_{lh}	t_{ohl}	K_{hl}
OSC in (32 k to 400 kHz) XIN1		—	—			D1			5.34	6.57	3.28	2.88
OSC out (32 k to 400 kHz) XOUT1		—	—			D1			0.96	0.12	0.66	0.13

• Outputs and bidirectional buffers ($I_{\text{OL}} = 2 \text{ mA}$)

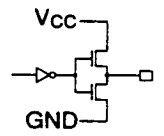
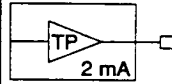
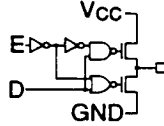
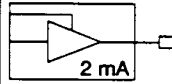
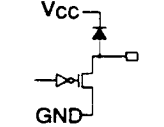
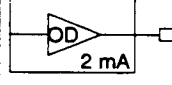
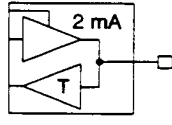
Macro			LV	Clamp Level when Open	Symbol	Symbol No.	Input Name	Output Name	Delay			
Function and Macro Name	Equiv. Circuit	Equiv. Gate Count							t_{plh} (ns)		t_{phl} (ns)	
									t_{olh}	K_{lh}	t_{ohl}	K_{hl}
Totem-pole output OT1		—	3			D1			1.92	0.114	2.22	0.097
Three-state output OZ1		—	4			D1	E		2.12	0.114	2.42	0.097
			5				D		1.92		2.22	
Open-drain output ODN1		—	3			D1			(t_{olz}) 1.92	(K_{lz}) —	(t_{ozl}) 2.22	(K_{zl}) 0.097
TTL-level I/O buffer ITO1	Refer to equivalent circuit of three-state output. Refer to equivalent circuit of input buffers.	—	4			D2	E		2.12	0.114	2.42	0.097
			5				D		1.92		2.22	
									0.53	0.16	1.19	0.14

• Outputs and bidirectional buffers ($I_{OL} = 2 \text{ mA}$) (cont)

Macro		Equiv. Gate Count	LV	Clamp Level when Open	Symbol	Symbol No.	Input Name	Output Name	Delay			
									t_{olh}	K_{lh}	t_{ohl}	K_{hl}
CMOS-level I/O buffer ICO1	Refer to equivalent circuit of three-state output.	—	4			D2	E		2.12	0.114	2.42	0.097
	Refer to equivalent circuit of input buffers.		5				D		1.92		2.22	
TTL-level I/O buffer with Schmitt-trigger ITSO1	Refer to equivalent circuit of three-state output.	—	4			D2	E		2.12	0.114	2.42	0.097
	Refer to equivalent circuit of input buffers.		5				D		1.92		2.22	
CMOS-level I/O buffer with Schmitt-trigger ICSO1	Refer to equivalent circuit of three-state output.	—	4			D2	E		2.12	0.114	2.42	0.097
	Refer to equivalent circuit of input buffers.		5				D		1.92		2.22	
Three-state output buffer with pull-up OZ1U		—	4			D2	E		2.12	0.114	2.42	0.097
			5				D		1.92		2.22	
Three-state output buffer with pull-down OZ1D		—	4			D2	E		2.12	0.114	2.42	0.097
			5				D		1.92		2.22	
Open-drain output buffer with pull-up ODN1U		—	3			D2			t_{olz} 1.92	(K_{lz}) —	t_{ozl} 2.22	(K_{zl}) 0.097
TTL-level I/O buffer with pull-up ITO1U	Refer to equivalent circuit of three-state output.	—	4			D2	E		2.12	0.114	2.42	0.097
	Refer to equivalent circuit of input buffers.		5				D		1.92		2.22	
									0.53	0.16	1.19	0.14

HG62G Series

• Outputs and bidirectional buffers ($I_{OL} = 2 \text{ mA}$) (cont)

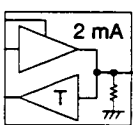
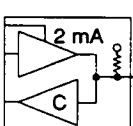
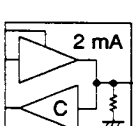
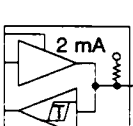
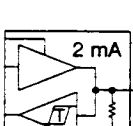
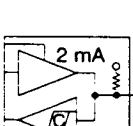
Macro			LV	Clamp Level when Open	Symbol	Symbol No.	Input Name	Output Name	Delay			
Function and Macro Name	Equiv. Circuit	Equiv. Gate Count							t_{pLH} (ns)		t_{pHL} (ns)	
									t_{0LH}	K_{LH}	t_{0HL}	K_{HL}
TTL-level I/O buffer with pull-down ITO1D	Refer to equivalent circuit of three-state output.	—	4			D2	E D		2.12	0.114	2.42	0.097
	Refer to equivalent circuit of input buffers.		5						1.92		2.22	
CMOS-level I/O buffer with pull-up ICO1U	Refer to equivalent circuit of three-state output.	—	4			D2	E D		2.12	0.114	2.42	0.097
	Refer to equivalent circuit of input buffers.		5						1.92		2.22	
CMOS-level I/O buffer with pull-down ICO1D	Refer to equivalent circuit of three-state output.	—	4			D2	E D		2.12	0.114	2.42	0.097
	Refer to equivalent circuit of input buffers.		5						1.92		2.22	
TTL-level Schmitt-trigger I/O buffer with pull-up ITSO1U	Refer to equivalent circuit of three-state output.	—	4			D2	E D		2.12	0.114	2.42	0.097
	Refer to equivalent circuit of input buffers.		5						1.92		2.22	
TTL-level Schmitt-trigger I/O buffer with pull-down ITSO1D	Refer to equivalent circuit of three-state output.	—	4			D2	E D		2.12	0.114	2.42	0.097
	Refer to equivalent circuit of input buffers.		5						1.92		2.22	
CMOS-level Schmitt-trigger I/O buffer with pull-up ICSO1U	Refer to equivalent circuit of three-state output.	—	4			D2	E D		2.12	0.114	2.42	0.097
	Refer to equivalent circuit of input buffers.		5						1.92		2.22	

• Outputs and bidirectional buffers ($I_{OL} = 2 \text{ mA}$) (cont)

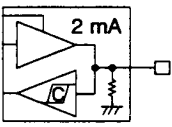
Macro			LV	Clamp Level when Open	Symbol	Sym- bol No.	Delay					
Function and Macro Name	Equiv. Circuit	Equiv. Gate Count					In- put Name	Out- put Name	t_{plh} (ns)		t_{phi} (ns)	
									t_{olh}	K_{lh}	t_{ohl}	K_{hl}
CMOS-level Schmitt-trigger I/O buffer with pull-down	Refer to equivalent circuit of three-state output. Refer to equivalent circuit of input buffers.	—	4		D2	E D	2.12	0.114	2.42	0.097		
			1.92					2.22				
ICSO1D			5				0.96	0.26	1.34	0.26		

Note: Propagation delay constant from enable terminals (E) as three-state output responds to $t_{olh} \rightarrow t_{olz}$ or t_{ozh} , and $t_{ohl} \rightarrow t_{ohz}$ or t_{ozl} .

• Outputs and bidirectional buffers ($I_{OL} = 8 \text{ mA}$)

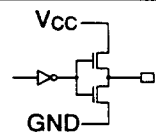
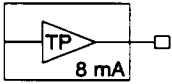
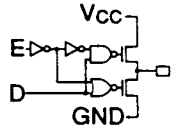
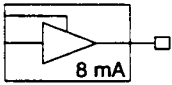
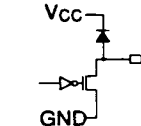
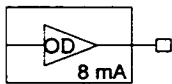
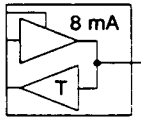
Macro			LV	Clamp Level when Open	Symbol	Sym- bol No.	Delay					
Function and Macro Name	Equiv. Circuit	Equiv. Gate Count					In- put Name	Out- put Name	t_{plh} (ns)		t_{phi} (ns)	
									t_{olh}	K_{lh}	t_{ohl}	K_{hl}
Totem-pole output OT3		—	3		D1		1.93	0.027	1.29	0.047		
Three-state output OZ3		—	4		D1	E	2.13	0.027	1.49	0.047		
			5			D	1.93		1.29			
Open-drain output ODN3		—	3		D1		(t_{olz}) 1.93	(K_{lz}) —	(t_{ozl}) 1.29	(K_{zl}) 0.047		
TTL-level I/O buffer	Refer to equivalent circuit of three-state output.	—	4		D2	E D	2.13	0.027	1.49	0.047		
ITO3	Refer to equivalent circuit of input buffers.		5						1.93		1.29	
							0.53	0.16	1.19	0.14		

HG62G Series

• Outputs and bidirectional buffers ($I_{OL} = 8 \text{ mA}$) (cont)

Macro		Equiv. Gate Count	LV	Clamp Level when Open	Symbol	Symbol No.	Input Name	Output Name	Delay			
									t_{plh} (ns)		t_{pfl} (ns)	
Function and Macro Name	Equiv. Circuit								t_{olh}	K_{lh}	t_{ofl}	K_{fl}
CMOS-level I/O buffer ICO3	Refer to equivalent circuit of three-state output.	—	4			D2	E		2.13	0.027	1.49	0.047
	D		1.93				1.29					
	Refer to equivalent circuit of input buffers.	5							0.65	0.17	0.82	0.14
TTL-level I/O buffer with Schmitt-trigger ITSO3	Refer to equivalent circuit of three-state output.	—	4			D2	E		2.13	0.027	1.49	0.047
	D		1.93				1.29					
	Refer to equivalent circuit of input buffers.	5							0.83	0.22	1.57	0.27
CMOS-level I/O buffer with Schmitt-trigger ICSO3	Refer to equivalent circuit of three-state output.	—	4			D2	E		2.13	0.027	1.49	0.047
	D		1.93				1.29					
	Refer to equivalent circuit of input buffers.	5							0.96	0.26	1.34	0.26
Three-state output buffer with pull-up OZ3U		—	4			D2	E		2.13	0.027	1.49	0.047
			D				1.93		1.29			
Three-state output buffer with pull-down OZ3D		—	4			D2	E		2.13	0.027	1.49	0.047
			D				1.93		1.29			
Open-drain output buffer with pull-up ODN3U		—	3			D2			(t_{olz}) 1.93	(K_{l2}) —	(t_{ofz}) 1.29	(K_{f2}) 0.047
TTL-level I/O buffer with pull-up ITO3U	Refer to equivalent circuit of three-state output.	—	4			D2	E		2.13	0.027	1.49	0.047
	D		1.93				1.29					
	Refer to equivalent circuit of input buffers.	5							0.53	0.16	1.19	0.14

• Outputs and bidirectional buffers ($I_{OL} = 8 \text{ mA}$) (cont)

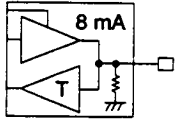
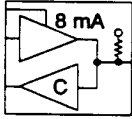
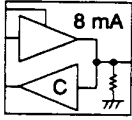
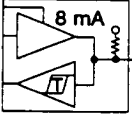
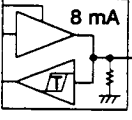
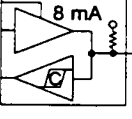
Macro			LV	Clamp Level when Open	Symbol	Symbol No.	Input Name	Output Name	Delay			
Function and Macro Name	Equiv. Circuit	Equiv. Gate Count							t_{pLH} (ns)		t_{pHL} (ns)	
									t_{0LH}	K_{LH}	t_{0HL}	K_{HL}
TTL-level I/O buffer with pull-down ITO3D	Refer to equivalent circuit of three-state output.	—	4		D2	E D		2.13	0.027	1.49	0.047	
	Refer to equivalent circuit of input buffers.	5	1.93						1.29			
CMOS-level I/O buffer with pull-up ICO3U	Refer to equivalent circuit of three-state output.	—	4		D2	E D		2.13	0.027	1.49	0.047	
	Refer to equivalent circuit of input buffers.	5	1.93						1.29		0.65	0.17
CMOS-level I/O buffer with pull-down ICO3D	Refer to equivalent circuit of three-state output.	—	4		D2	E D		2.13	0.027	1.49	0.047	
	Refer to equivalent circuit of input buffers.	5	1.93						1.29		0.65	0.17
TTL-level Schmitt-trigger I/O buffer with pull-up ITSO3U	Refer to equivalent circuit of three-state output.	—	4		D2	E D		2.13	0.027	1.49	0.047	
	Refer to equivalent circuit of input buffers.	5	1.93						1.29		0.83	0.22
TTL-level Schmitt-trigger I/O buffer with pull-down ITSO3D	Refer to equivalent circuit of three-state output.	—	4		D2	E D		2.13	0.027	1.49	0.047	
	Refer to equivalent circuit of input buffers.	5	1.93						1.29		0.83	0.22
CMOS-level Schmitt-trigger I/O buffer with pull-up ICSO3U	Refer to equivalent circuit of three-state output.	—	4		D2	E D		2.13	0.027	1.49	0.047	
	Refer to equivalent circuit of input buffers.	5	1.93						1.29		0.96	0.26

HG62G Series

• Outputs and bidirectional buffers ($I_{OL} = 8 \text{ mA}$) (cont)

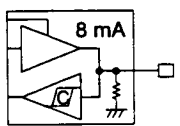
Macro		Equiv. Gate Count	LV	Clamp Level when Open	Symbol	Sym- bol No.	In- put Name	Out- put Name	Delay			
Function and Macro Name	Equiv. Circuit								t_{olh}	K_{lh}	t_{ohl}	K_{hl}
CMOS-level Schmitt-trigger I/O buffer with pull-down	Refer to equivalent circuit of three-state output.	—	4			D2	E		2.13	0.027	1.49	0.047
	Refer to equivalent circuit of input buffers.		5						1.93		1.29	
ICSO3D									0.96	0.26	1.34	0.26

Note: Propagation delay constant from enable terminals (E) as three-state output responds to $t_{olh} \rightarrow t_{olz}$ or t_{ozh} , and $t_{ohl} \rightarrow t_{ohz}$ or t_{ozl} .

• GND noise reduction buffers ($I_{OL} = 8 \text{ mA}$)

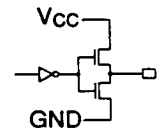
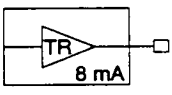
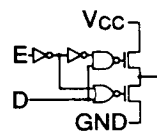
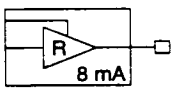
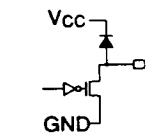
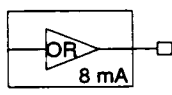
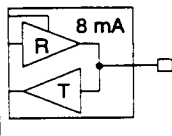
Macro		Equiv. Gate Count	LV	Clamp Level when Open	Symbol	Sym- bol No.	In- put Name	Out- put Name	Delay			
Function and Macro Name	Equiv. Circuit								t_{olh}	K_{lh}	t_{ohl}	K_{hl}
Totem-pole output OT3R		—	2			D1			2.92	0.035	5.37	0.051
Three-state output OZ3R		—	4			D1	E		2.35	0.037	3.84	0.054
			6				D		2.15		3.64	
Open-drain output ODN3R		—	2			D1			(t_{olz}) 2.92	(K_{lz}) —	(t_{ozl}) 5.37	(K_{zl}) 0.051
TTL-level I/O buffer ITO3R	Refer to equivalent circuit of three-state output.	—	4			D2	E		2.35	0.037	3.84	0.054
	Refer to equivalent circuit of input buffers.		6				D		2.15		3.64	
									0.53	0.16	1.19	0.14

HG62G Series

• GND noise reduction buffers ($I_{OL} = 8 \text{ mA}$) (cont)

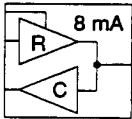
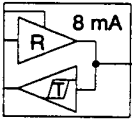
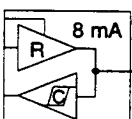
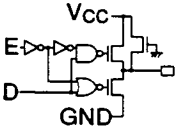
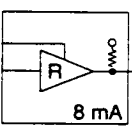
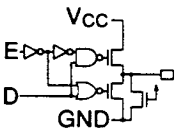
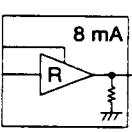
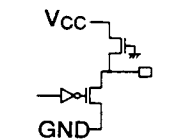
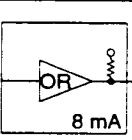
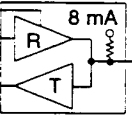
Macro			LV	Clamp Level when Open	Symbol	Sym-bol No.	In-put Name	Out-put Name	Delay			
									t_{plh} (ns)	t_{phi} (ns)	t_{ohl}	K_{hl}
Function and Macro Name	Equiv. Circuit	Equiv. Gate Count							t_{olh}	K_{lh}	t_{ohl}	K_{hl}
CMOS-level I/O buffer ICO3R	Refer to equivalent circuit of three-state output.	—	4			D2	E D		2.35	0.037	3.84	0.054
	2.15		3.64									
	Refer to equivalent circuit of input buffers.		6						0.65	0.17	0.82	0.14
TTL-level I/O buffer with Schmitt-trigger ITSO3R	Refer to equivalent circuit of three-state output.	—	4			D2	E D		2.35	0.037	3.84	0.054
	2.15		3.64									
	Refer to equivalent circuit of input buffers.		6						0.83	0.22	1.57	0.27
CMOS-level I/O buffer with Schmitt-trigger ICSO3R	Refer to equivalent circuit of three-state output.	—	4			D2	E D		2.35	0.037	3.84	0.054
	2.15		3.64									
	Refer to equivalent circuit of input buffers.		6						0.96	0.26	1.34	0.26
Three-state output buffer with pull-up OZ3RU		—	4			D2	E D		2.35	0.037	3.84	0.054
			6									
Three-state output buffer with pull-down OZ3RD		—	4			D2	E D		2.35	0.037	3.84	0.054
			6									
Open-drain output buffer with pull-up ODN3RU		—	2			D2			(t_{olz}) 2.92	(K_{lz}) —	(t_{ozl}) 5.37	(K_{zl}) 0.051
TTL-level I/O buffer with pull-up ITO3RU	Refer to equivalent circuit of three-state output.	—	4			D2	E D		2.35	0.037	3.84	0.054
	2.15		3.64									
	Refer to equivalent circuit of input buffers.		6						0.53	0.16	1.19	0.14

HG62G Series

• GND noise reduction buffers ($I_{OL} = 8 \text{ mA}$) (cont)

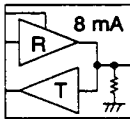
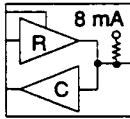
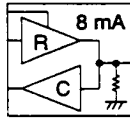
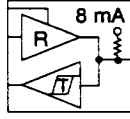
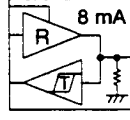
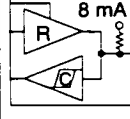
Macro			LV	Clamp Level when Open	Symbol	Symbol No.	Input Name	Output Name	Delay			
Function and Macro Name	Equiv. Circuit	Equiv. Gate Count							t_{plh} (ns)		t_{phl} (ns)	
									t_{olh}	K_{lh}	t_{ohl}	K_{hl}
TTL-level I/O buffer with pull-down ITO3RD	Refer to equivalent circuit of three-state output.	—	4		D2	E D		2.35	0.037	3.84	0.054	
	Refer to equivalent circuit of input buffers.	6	2.15						3.64			
CMOS-level I/O buffer with pull-up ICO3RU	Refer to equivalent circuit of three-state output.	—	4		D2	E D		2.35	0.037	3.84	0.054	
	Refer to equivalent circuit of input buffers.	6	2.15						3.64			
CMOS-level I/O buffer with pull-down ICO3RD	Refer to equivalent circuit of three-state output.	—	4		D2	E D		2.35	0.037	3.84	0.054	
	Refer to equivalent circuit of input buffers.	6	2.15						3.64			
TTL-level Schmitt-trigger I/O buffer with pull-up ITSO3RU	Refer to equivalent circuit of three-state output.	—	4		D2	E D		2.35	0.037	3.84	0.054	
	Refer to equivalent circuit of input buffers.	6	2.15						3.64	0.83	0.22	1.57
TTL-level Schmitt-trigger I/O buffer with pull-down ITSO3RD	Refer to equivalent circuit of three-state output.	—	4		D2	E D		2.35	0.037	3.84	0.054	
	Refer to equivalent circuit of input buffers.	6	2.15						3.64	0.83	0.22	1.57
CMOS-level Schmitt-trigger I/O buffer with pull-up ICSO3RU	Refer to equivalent circuit of three-state output.	—	4		D2	E D		2.35	0.037	3.84	0.054	
	Refer to equivalent circuit of input buffers.	6	2.15						3.64	0.96	0.26	1.34

• GND noise reduction buffers ($I_{OL} = 8 \text{ mA}$) (cont)

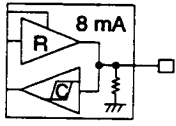
Macro			LV	Clamp Level when Open	Symbol	Sym- bol No.	In- put Name	Out- put Name	Delay			
Function and Macro Name	Equiv. Circuit	Equiv. Gate Count							t_{plh} (ns)		t_{phi} (ns)	
									t_{olh}	K_{lh}	t_{ohl}	K_{hl}
CMOS-level Schmitt-trigger I/O buffer with pull-down ICSO3RD	Refer to equivalent circuit of three-state output. Refer to equivalent circuit of input buffers.	—	4		D2	E	D	2.35	0.037	3.84	0.054	
			6					2.15		3.64		
								0.96	0.26	1.34	0.26	

Note: Propagation delay constant from enable terminals (E) as three-state output responds to $t_{olh} \rightarrow t_{olz}$ or t_{ozh} , and $t_{ohl} \rightarrow t_{ozl}$ or t_{ozl} .

• Outputs and bidirectional buffers ($I_{OL} = 12 \text{ mA}$)

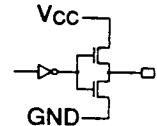
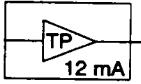
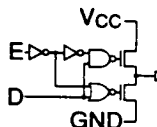
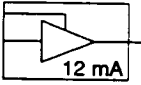
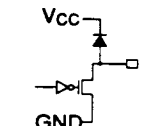
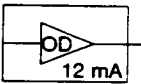
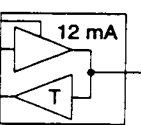
Macro			LV	Clamp Level when Open	Symbol	Sym- bol No.	In- put Name	Out- put Name	Delay			
Function and Macro Name	Equiv. Circuit	Equiv. Gate Count							t_{plh} (ns)		t_{phi} (ns)	
									t_{olh}	K_{lh}	t_{ohl}	K_{hl}
Totem-pole output OT4		—	5		D1			1.92	0.022	1.56	0.032	
Three-state output OZ4		—	5		D1	E		2.12	0.022	1.76	0.032	
			6			D		1.92		1.56		
Open-drain output ODN4		—	5		D1			(t_{olz}) 1.92	(K_{lz}) —	(t_{ozl}) 1.56	(K_{zl}) 0.032	
TTL-level I/O buffer ITO4	Refer to equivalent circuit of three-state output. Refer to equivalent circuit of input buffers.	—	5		D2	E		2.12	0.022	1.76	0.032	
			6			D		1.92		1.56		
								0.53	0.16	1.19	0.14	

HG62G Series

• Outputs and bidirectional buffers ($I_{OL} = 12 \text{ mA}$) (cont)

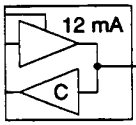
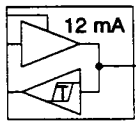
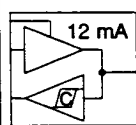
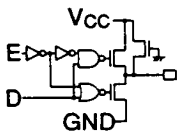
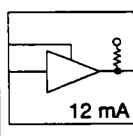
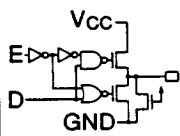
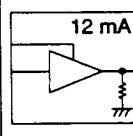
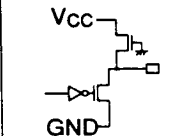
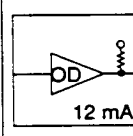
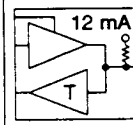
Macro			LV	Clamp Level when Open	Symbol	Symbol No.	Input Name	Output Name	Delay			
Function and Macro Name	Equiv. Circuit	Equiv. Gate Count							t_{plh} (ns)		t_{phi} (ns)	
									t_{olh}	K_{th}	t_{ohl}	K_{ht}
CMOS-level I/O buffer ICO4	Refer to equivalent circuit of three-state output.	—	5			D2	E D		2.12	0.022	1.76	0.032
	1.92								1.56			
	Refer to equivalent circuit of input buffers.		6						0.65	0.17	0.82	0.14
TTL-level I/O buffer with Schmitt-trigger ITSO4	Refer to equivalent circuit of three-state output.	—	5			D2	E D		2.12	0.022	1.76	0.032
	1.92								1.56			
	Refer to equivalent circuit of input buffers.		6						0.83	0.22	1.57	0.27
CMOS-level I/O buffer with Schmitt-trigger ICSO4	Refer to equivalent circuit of three-state output.	—	5			D2	E D		2.12	0.022	1.76	0.032
	1.92								1.56			
	Refer to equivalent circuit of input buffers.		6						0.96	0.26	1.34	0.26
Three-state output buffer with pull-up OZ4U		—	5			D2	E D		2.12	0.022	1.76	0.032
			1.92							1.56		
			6									
Three-state output buffer with pull-down OZ4D		—	5			D2	E D		2.12	0.022	1.76	0.032
			1.92							1.56		
			6									
Open-drain output buffer with pull-up ODN4U		—	5			D2			(t_{olz}) 1.92	(K_{lz}) —	(t_{ozl}) 1.56	(K_{zl}) 0.032
TTL-level I/O buffer with pull-up ITO4U	Refer to equivalent circuit of three-state output.	—	5			D2	E D		2.12	0.022	1.76	0.032
	1.92								1.56			
	Refer to equivalent circuit of input buffers.		6						0.53	0.16	1.19	0.14

• Outputs and bidirectional buffers ($I_{OL} = 12 \text{ mA}$) (cont)

Macro			LV	Clamp Level when Open	Symbol	Symbol No.	Input Name	Output Name	Delay			
									t_{plh} (ns)		t_{phl} (ns)	
Function and Macro Name	Equiv. Circuit	Equiv. Gate Count							t_{olh}	K_{lh}	t_{ohl}	K_{hl}
TTL-level I/O buffer with pull-down ITO4D	Refer to equivalent circuit of three-state output.	—	5			D2	E D		2.12	0.022	1.76	0.032
	Refer to equivalent circuit of input buffers.		6						1.92		1.56	
CMOS-level I/O buffer with pull-up ICO4U	Refer to equivalent circuit of three-state output.	—	5			D2	E D		2.12	0.022	1.76	0.032
	Refer to equivalent circuit of input buffers.		6						1.92		1.56	
CMOS-level I/O buffer with pull-down ICO4D	Refer to equivalent circuit of three-state output.	—	5			D2	E D		2.12	0.022	1.76	0.032
	Refer to equivalent circuit of input buffers.		6						1.92		1.56	
TTL-level Schmitt-trigger I/O buffer with pull-up ITSO4U	Refer to equivalent circuit of three-state output.	—	5			D2	E D		2.12	0.022	1.76	0.032
	Refer to equivalent circuit of input buffers.		6						1.92		1.56	0.83
TTL-level Schmitt-trigger I/O buffer with pull-down ITSO4D	Refer to equivalent circuit of three-state output.	—	5			D2	E D		2.12	0.022	1.76	0.032
	Refer to equivalent circuit of input buffers.		6						1.92		1.56	0.83
CMOS-level Schmitt-trigger I/O buffer with pull-up ICSO4U	Refer to equivalent circuit of three-state output.	—	5			D2	E D		2.12	0.022	1.76	0.032
	Refer to equivalent circuit of input buffers.		6						1.92		1.56	0.96

HG62G Series

- Outputs and bidirectional buffers ($I_{OL} = 12 \text{ mA}$) (cont)

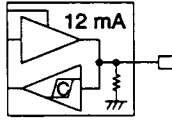
Macro			LV	Clamp Level when Open	Symbol	Sym- bol No.	Delay					
Function and Macro Name	Equiv. Circuit	Equiv. Gate Count					Input Name	Output Name	$t_{plh} \text{ (ns)}$		$t_{phi} \text{ (ns)}$	
									t_{olh}	K_{lh}	t_{ohl}	K_{hl}
CMOS-level Schmitt-trigger I/O buffer with pull-down ICSO4D	Refer to equivalent circuit of three-state output. Refer to equivalent circuit of input buffers.	—	5			D2	E		2.12	0.022	1.76	0.032
			D				1.92			1.56		
			6						0.96	0.26	1.34	0.26

Note: Propagation delay constant from enable terminals (E) as three-state output responds to $t_{olh} \rightarrow t_{olz}$ or t_{ozh} , and $t_{ohl} \rightarrow t_{ohz}$ or t_{ozl} .

- Outputs and bidirectional buffers ($I_{OL} = 12 \text{ mA}$ high speed buffer)

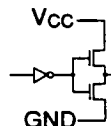
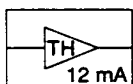
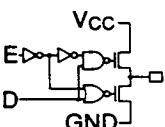
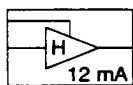
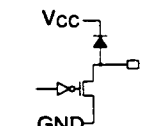
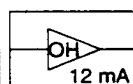
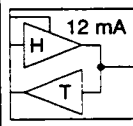
Macro			LV	Clamp Level when Open	Symbol	Sym- bol No.	Delay					
Function and Macro Name	Equiv. Circuit	Equiv. Gate Count					Input Name	Output Name	$t_{plh} \text{ (ns)}$		$t_{phi} \text{ (ns)}$	
									t_{olh}	K_{lh}	t_{ohl}	K_{hl}
Totem-pole output OT4H		—	5			D1			1.05	0.016	0.60	0.023
Three-state output OZ4H		—	5			D1	E		1.25	0.016	0.80	0.023
			6	D				1.05		0.60		
Open-drain output ODN4H		—	5			D1			(t_{olz}) 1.05	(K_{lz}) —	(t_{ozl}) 0.60	(K_{zl}) 0.023
TTL-level I/O buffer ITO4H	Refer to equivalent circuit of three-state output. Refer to equivalent circuit of input buffers.	—	5			D2	E		1.25	0.016	0.80	0.023
			6	D				1.05		0.60		
									0.53	0.16	1.19	0.14

• Outputs and bidirectional buffers ($I_{OL} = 12 \text{ mA}$ high speed buffer) (cont)

Macro	Function and Macro Name	Equiv. Circuit	Equiv. Gate Count	LV	Clamp Level when Open	Symbol	Symbol No.	In-put Name	Out-put Name	Delay			
										t_{plh} (ns)		t_{phi} (ns)	
										t_{olh}	K_{lh}	t_{ohl}	K_{hl}
CMOS-level I/O buffer ICO4H	Refer to equivalent circuit of three-state output.		—	5			D2	E D		1.25	0.016	0.80	0.023
				6						1.05		0.60	
TTL-level I/O buffer with Schmitt-trigger ITSO4H	Refer to equivalent circuit of three-state output.		—	5			D2	E D		1.25	0.016	0.80	0.023
				6						1.05		0.60	
CMOS-level I/O buffer with Schmitt-trigger ICSO4H	Refer to equivalent circuit of three-state output.		—	5			D2	E D		1.25	0.016	0.80	0.023
				6						1.05		0.60	
Three-state output buffer with pull-up OZ4HU			—	5			D2	E D		1.25	0.016	0.80	0.023
				6						1.05		0.60	
Three-state output buffer with pull-down OZ4HD			—	5			D2	E D		1.25	0.016	0.80	0.023
				6						1.05		0.60	
Open-drain output buffer with pull-up ODN4HU			—	5			D2			(t_{olz}) 1.05	(K_{lz}) —	(t_{ozl}) 0.60	(K_{zl}) 0.023
TTL-level I/O buffer with pull-up ITO4HU	Refer to equivalent circuit of three-state output.		—	5			D2	E D		1.25	0.016	0.80	0.023
				6						1.05		0.60	
TTL-level I/O buffer with pull-up ITO4HU	Refer to equivalent circuit of input buffers.		—	5			D2	E D		0.53	0.16	1.19	0.14
				6									

HG62G Series

• Outputs and bidirectional buffers ($I_{OL} = 12 \text{ mA}$ high speed buffer) (cont)

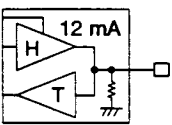
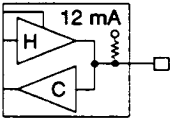
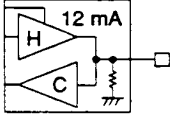
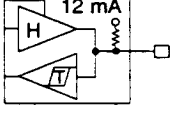
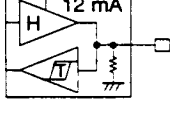
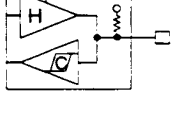
Macro		Equiv. Gate Count	LV	Clamp Level when Open	Symbol	Symbol No.	Input Name	Output Name	Delay			
Function and Macro Name	Equiv. Circuit								t_{plh} (ns)		t_{phl} (ns)	
									t_{olh}	K_{lh}	t_{ohl}	K_{hl}
TTL-level I/O buffer with pull-down	Refer to equivalent circuit of three-state output.	—	5			D2	E D		1.25	0.016	0.80	0.023
									1.05		0.60	
ITO4HD	Refer to equivalent circuit of input buffers.		6						0.53	0.16	1.19	0.14
CMOS-level I/O buffer with pull-up	Refer to equivalent circuit of three-state output.	—	5			D2	E D		1.25	0.016	0.80	0.023
									1.05		0.60	
ICO4HU	Refer to equivalent circuit of input buffers.		6						0.65	0.17	0.82	0.14
CMOS-level I/O buffer with pull-down	Refer to equivalent circuit of three-state output.	—	5			D2	E D		1.25	0.016	0.80	0.023
									1.05		0.60	
ICO4HD	Refer to equivalent circuit of input buffers.		6						0.65	0.17	0.82	0.14
TTL-level Schmitt-trigger I/O buffer with pull-up	Refer to equivalent circuit of three-state output.	—	5			D2			1.25	0.016	0.80	0.023
									1.05		0.60	
ITSO4HU	Refer to equivalent circuit of input buffers.		6						0.83	0.22	1.57	0.27
TTL-level Schmitt-trigger I/O buffer with pull-down	Refer to equivalent circuit of three-state output.	—	5			D2			1.25	0.016	0.80	0.023
									1.05		0.60	
ITSO4HD	Refer to equivalent circuit of input buffers.		6						0.83	0.22	1.57	0.27
CMOS-level Schmitt-trigger I/O buffer with pull-up	Refer to equivalent circuit of three-state output.	—	5			D2			1.25	0.016	0.80	0.023
									1.05		0.60	
ICSO4HU	Refer to equivalent circuit of input buffers.		6						0.96	0.26	1.34	0.26

• Outputs and bidirectional buffers ($I_{OL} = 12\text{ mA}$ high speed buffer) (cont)

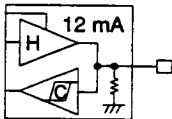
Macro			LV	Clamp Level when Open	Symbol	Sym- bol No.	Delay					
Function and Macro Name	Equiv. Circuit	Equiv. Gate Count					In- put Name	Out- put Name	t_{plh} (ns)		t_{phl} (ns)	
									t_{olh}	K_{lh}	t_{ohl}	K_{hl}
CMOS-level Schmitt-trigger I/O buffer with pull-down ICSO4HD	Refer to equivalent circuit of three-state output.	—	5		D2			1.25	0.016	0.80	0.023	
	Refer to equivalent circuit of input buffers.	6	1.05						0.60			
								0.96	0.26	1.34	0.26	

Note: Propagation delay constant from enable terminals (E) as three-state output responds to $t_{olh} \rightarrow t_{olz}$ or t_{ozh} , and $t_{ohl} \rightarrow t_{ohz}$ or t_{ozl} .

• GND noise reduction buffers ($I_{OL} = 12\text{ mA}$)

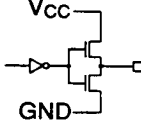
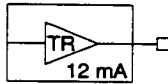
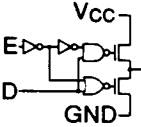
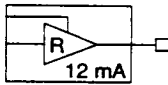
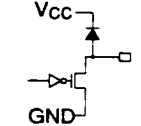
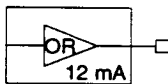
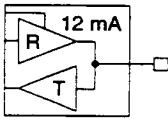
Macro			LV	Clamp Level when Open	Symbol	Sym- bol No.	Delay					
Function and Macro Name	Equiv. Circuit	Equiv. Gate Count					In- put Name	Out- put Name	t_{plh} (ns)		t_{phl} (ns)	
									t_{olh}	K_{lh}	t_{ohl}	K_{hl}
Totem-pole output OT4R		—	2		D1			3.22	0.029	6.56	0.043	
Three-state output OZ4R		—	4		D1	E		2.36	0.031	4.03	0.046	
			6		D		2.16		3.83			
Open-drain output ODN4R		—	2		D1			(t_{olz}) 3.22	(K_{lz}) —	(t_{ozl}) 6.56	(K_{zl}) 0.043	
TTL-level I/O buffer ITO4R	Refer to equivalent circuit of three-state output. Refer to equivalent circuit of input buffers.	—	4		D2	E D		2.36	0.031	4.03	0.046	
			6						2.16		3.83	
								0.53	0.16	1.19	0.14	

HG62G Series

• GND noise reduction buffers ($I_{OL} = 12 \text{ mA}$) (cont)

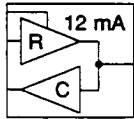
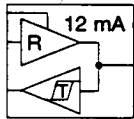
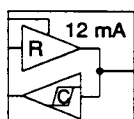
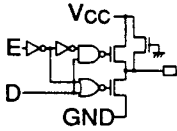
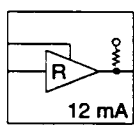
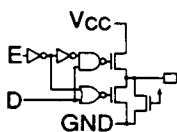
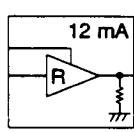
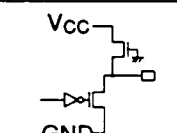
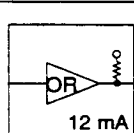
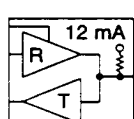
Macro		Equiv. Gate Count	LV	Clamp Level when Open	Symbol	Sym- bol No.	In- put Name	Out- put Name	Delay			
Function and Macro Name	Equiv. Circuit								t_{plh} (ns)		t_{phl} (ns)	
									t_{olh}	K_{lh}	t_{ohl}	K_{hl}
CMOS-level I/O buffer ICO4R	Refer to equivalent circuit of three-state output.	—	4			D2	E D		2.36	0.031	4.03	0.046
	Refer to equivalent circuit of input buffers.		6						2.16		3.83	
TTL-level I/O buffer with Schmitt-trigger ITSO4R	Refer to equivalent circuit of three-state output.	—	4			D2	E D		2.36	0.031	4.03	0.046
	Refer to equivalent circuit of input buffers.		6						2.16		3.83	
CMOS-level I/O buffer with Schmitt-trigger ICSO4R	Refer to equivalent circuit of three-state output.	—	4			D2	E D		2.36	0.031	4.03	0.046
	Refer to equivalent circuit of input buffers.		6						2.16		3.83	
Three-state output buffer with pull-up OZ4RU		—	4			D2	E D		2.36	0.031	4.03	0.046
			6						2.16		3.83	
Three-state output buffer with pull-down OZ4RD		—	4			D2	E D		2.36	0.031	4.03	0.046
			6						2.16		3.83	
Open-drain output buffer with pull-up ODN4RU		—	2			D2			(t_{olz}) 3.22	(K_{lz}) —	(t_{ozl}) 6.56	(K_{zl}) 0.043
TTL-level I/O buffer with pull-up ITO4RU	Refer to equivalent circuit of three-state output.	—	4			D2	E D		2.36	0.031	4.03	0.046
	Refer to equivalent circuit of input buffers.		6						2.16		3.83	

• GND noise reduction buffers ($I_{OL} = 12\text{ mA}$) (cont)

Macro	Function and Macro Name	Equiv. Circuit	Equiv. Gate Count	LV	Clamp Level when Open	Symbol	Sym-bol No.	In-put Name	Out-put Name	Delay			
										t_{plh} (ns)		t_{phi} (ns)	
										t_{olh}	K_{lh}	t_{ohl}	K_{hl}
TTL-level I/O buffer with pull-down ITO4RD	Refer to equivalent circuit of three-state output.		—	4		D2	E D		2.36	0.031	4.03	0.046	
	2.16								3.83				
	Refer to equivalent circuit of input buffers.			6					0.53	0.16	1.19	0.14	
CMOS-level I/O buffer with pull-up ICO4RU	Refer to equivalent circuit of three-state output.		—	4		D2	E D		2.36	0.031	4.03	0.046	
	2.16								3.83				
	Refer to equivalent circuit of input buffers.			6					0.65	0.17	0.82	0.14	
CMOS-level I/O buffer with pull-down ICO4RD	Refer to equivalent circuit of three-state output.		—	4		D2	E D		2.36	0.031	4.03	0.046	
	2.16								3.83				
	Refer to equivalent circuit of input buffers.			6					0.65	0.17	0.82	0.14	
TTL-level Schmitt-trigger I/O buffer with pull-up ITSO4RU	Refer to equivalent circuit of three-state output.		—	4		D2	E D		2.36	0.031	4.03	0.046	
	2.16								3.83				
	Refer to equivalent circuit of input buffers.			6					0.83	0.22	1.57	0.27	
TTL-level Schmitt-trigger I/O buffer with pull-down ITSO4RD	Refer to equivalent circuit of three-state output.		—	4		D2	E D		2.36	0.031	4.03	0.046	
	2.16								3.83				
	Refer to equivalent circuit of input buffers.			6					0.83	0.22	1.57	0.27	
CMOS-level Schmitt-trigger I/O buffer with pull-up ICSO4RU	Refer to equivalent circuit of three-state output.		—	4		D2	E D		2.36	0.031	4.03	0.046	
	2.16								3.83				
	Refer to equivalent circuit of input buffers.			6					0.96	0.26	1.34	0.26	

HG62G Series

• GND noise reduction buffers ($I_{OL} = 12 \text{ mA}$) (cont)

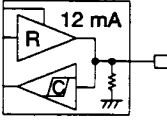
Macro			LV	Clamp Level when Open	Symbol	Sym- bol No.	In- put Name	Out- put Name	Delay			
Function and Macro Name	Equiv. Circuit	Equiv. Gate Count							t_{plh} (ns)		t_{phi} (ns)	
									t_{olh}	K_{lh}	t_{ohl}	K_{hl}
CMOS-level Schmitt-trigger I/O buffer with pull-down ICSO4RD	Refer to equivalent circuit of three-state output. Refer to equivalent circuit of input buffers.	—	4			D2	E D		2.36	0.031	4.03	0.046
			6						2.16		3.83	
									0.96	0.26	1.34	0.26

Note: Propagation delay constant from enable terminals (E) as three-state output responds to $t_{olh} \rightarrow t_{olz}$ or t_{ozh} , and $t_{ohl} \rightarrow t_{ohz}$ or t_{ozl} .

• Outputs and bidirectional buffers ($I_{OL} = 24 \text{ mA}$)

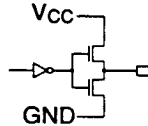
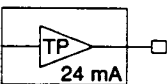
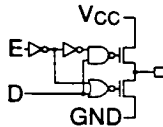
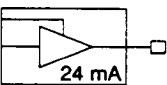
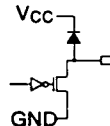
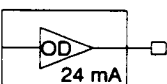
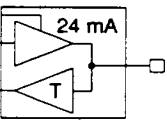

Macro			LV	Clamp Level when Open	Symbol	Sym- bol No.	In- put Name	Out- put Name	Delay			
Function and Macro Name	Equiv. Circuit	Equiv. Gate Count							t_{plh} (ns)		t_{phi} (ns)	
									t_{olh}	K_{lh}	t_{ohl}	K_{hl}
Totem-pole output OT5		—	5			D1			1.05	0.016	0.60	0.023
Three-state output OZ5		—	5			D1	E		1.25	0.016	0.80	0.023
			6			D		1.05		0.60		
Open-drain output ODN5		—	5			D1			(t_{olz}) 1.05	(K_{lz}) —	(t_{ozl}) 0.60	(K_{zl}) 0.023
TTL-level I/O buffer ITO5	Refer to equivalent circuit of three-state output. Refer to equivalent circuit of input buffers.	—	5			D2	E D		1.25 1.05	0.016	0.80 0.60	0.023
			6						0.53	0.16	1.19	0.14

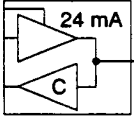
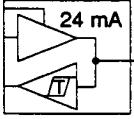
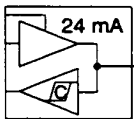
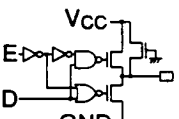
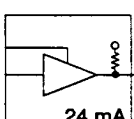
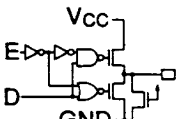
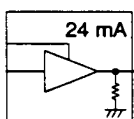
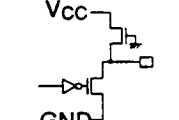
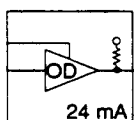
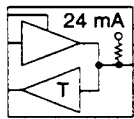
• Outputs and bidirectional buffers ($I_{OL} = 24 \text{ mA}$) (cont)

Macro			LV	Clamp Level when Open	Symbol	Sym- bol No.	In- put Name	Out- put Name	Delay			
									t_{olh} (ns)	K_{lh}	t_{ohl} (ns)	K_{hl}
CMOS-level I/O buffer IC05	Refer to equivalent circuit of three-state output.	—	5			D2	E		1.25	0.016	0.80	0.023
			6				D		1.05		0.60	
	Refer to equivalent circuit of input buffers.								0.65	0.17	0.82	0.14
TTL-level I/O buffer with Schmitt-trigger ITSO5	Refer to equivalent circuit of three-state output.	—	5			D2	E		1.25	0.016	0.80	0.023
			6				D		1.05		0.60	
	Refer to equivalent circuit of input buffers.								0.83	0.22	1.57	0.27
CMOS-level I/O buffer with Schmitt-trigger ICSO5	Refer to equivalent circuit of three-state output.	—	5			D2	E		1.25	0.016	0.80	0.023
			6				D		1.05		0.60	
	Refer to equivalent circuit of input buffers.								0.96	0.26	1.34	0.26
Three-state output buffer with pull-up OZ5U		—	5			D2	E		1.25	0.016	0.80	0.023
			6				D		1.05		0.60	
Three-state output buffer with pull-down OZ5D		—	5			D2	E		1.25	0.016	0.80	0.023
			6				D		1.05		0.60	
Open-drain output buffer with pull-up ODN5U		—	5			D2			(t_{olz}) 1.05	(K_{lz}) —	(t_{ozl}) 0.60	(K_{zl}) 0.023
TTL-level I/O buffer with pull-up ITO5U	Refer to equivalent circuit of three-state output.	—	5			D2	E		1.25	0.016	0.80	0.023
	Refer to equivalent circuit of input buffers.		6					D		1.05		0.60
									0.53	0.16	1.19	0.14

HG62G Series

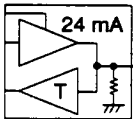
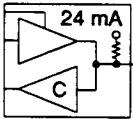
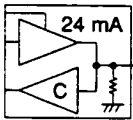
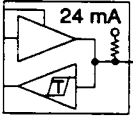
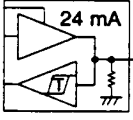
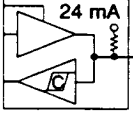
• Outputs and bidirectional buffers ($I_{OL} = 24 \text{ mA}$) (cont)

Macro			LV	Clamp Level when Open	Symbol	Sym- bol No.	In- put Name	Out- put Name	Delay			
Function and Macro Name	Equiv. Circuit	Equiv. Gate Count							t_{plh} (ns)		t_{phl} (ns)	
									t_{olh}	K_{lh}	t_{ohl}	K_{hl}
TTL-level I/O buffer with pull-down ITO5D	Refer to equivalent circuit of three-state output.	—	5			D2	E D		1.25	0.016	0.80	0.023
	Refer to equivalent circuit of input buffers.		6						1.05		0.60	
CMOS-level I/O buffer with pull-up ICO5U	Refer to equivalent circuit of three-state output.	—	5			D2	E D		1.25	0.016	0.80	0.023
	Refer to equivalent circuit of input buffers.		6						1.05		0.60	
CMOS-level I/O buffer with pull-down ICO5D	Refer to equivalent circuit of three-state output.	—	5			D2	E D		1.25	0.016	0.80	0.023
	Refer to equivalent circuit of input buffers.		6						1.05		0.60	
TTL-level Schmitt-trigger I/O buffer with pull-up ITS05U	Refer to equivalent circuit of three-state output.	—	5			D2			1.25	0.016	0.80	0.023
	Refer to equivalent circuit of input buffers.		6						1.05		0.60	
TTL-level Schmitt-trigger I/O buffer with pull-down ITS05D	Refer to equivalent circuit of three-state output.	—	5			D2			1.25	0.016	0.80	0.023
	Refer to equivalent circuit of input buffers.		6						1.05		0.60	
CMOS-level Schmitt-trigger I/O buffer with pull-up ICSO5U	Refer to equivalent circuit of three-state output.	—	5			D2			1.25	0.016	0.80	0.023
	Refer to equivalent circuit of input buffers.		6						1.05		0.60	
CMOS-level Schmitt-trigger I/O buffer with pull-down ICSO5D	Refer to equivalent circuit of three-state output.	—	5			D2			1.25	0.016	0.80	0.023
	Refer to equivalent circuit of input buffers.		6						1.05		0.60	

HG62G Series

• Outputs and bidirectional buffers ($I_{OL} = 24\text{ mA}$) (cont)

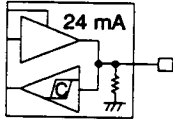
Macro			LV	Clamp Level when Open	Symbol	Sym- bol No.	In- put Name	Out- put Name	Delay			
Function and Macro Name	Equiv. Circuit	Equiv. Gate Count							t_{plh} (ns)		t_{phi} (ns)	
									t_{olh}	K_{th}	t_{ohl}	K_{hl}
CMOS-level Schmitt-trigger I/O buffer with pull-down ICSO5D	Refer to equivalent circuit of three-state output.	—	5		D2			1.25	0.016	0.80	0.023	
	Refer to equivalent circuit of input buffers.	6	1.05						0.60			
								0.96	0.26	1.34	0.26	

Note: Propagation delay constant from enable terminals (E) as three-state output responds to $t_{olh} \rightarrow t_{olz}$ or t_{ozh} , and $t_{ohl} \rightarrow t_{ohz}$ or t_{ozl} .

• GND noise reduction buffers ($I_{OL} = 24\text{ mA}$)

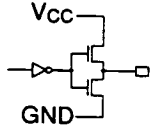
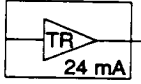
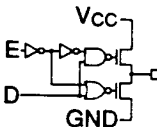
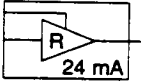
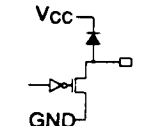
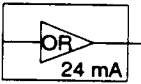
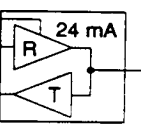
Macro			LV	Clamp Level when Open	Symbol	Sym- bol No.	In- put Name	Out- put Name	Delay			
Function and Macro Name	Equiv. Circuit	Equiv. Gate Count							t_{plh} (ns)		t_{phi} (ns)	
									t_{olh}	K_{th}	t_{ohl}	K_{hl}
Totempole output OT5R		—	2		D1			3.06	0.016	6.30	0.037	
Three-state output OZ5R		—	3		D1	E		2.38	0.017	4.00	0.030	
			5			D		2.18		3.80		
Open-drain output ODN5R		—	2		D1			(t_{olz}) 3.06	(K_{lz}) —	(t_{ozl}) 6.30	(K_{zl}) 0.037	
TTL-level I/O buffer ITO5R	Refer to equivalent circuit of three-state output.	—	3		D2	E		2.38	0.017	4.00	0.030	
	Refer to equivalent circuit of input buffers.		5			D		2.18		3.80		
								0.53	0.16	1.19	0.14	

HG62G Series

• GND noise reduction buffers ($I_{OL} = 24 \text{ mA}$) (cont)

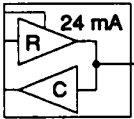
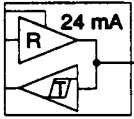
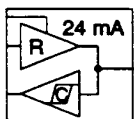
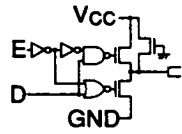
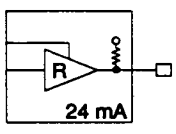
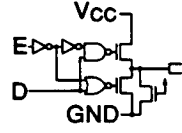
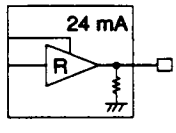
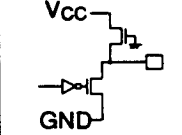
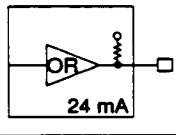
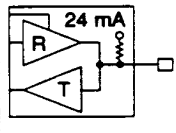
Macro			LV	Clamp Level when Open	Symbol	Sym- bol No.	In- put Name	Out- put Name	Delay			
Function and Macro Name	Equiv. Circuit	Equiv. Gate Count							t_{plh} (ns)		t_{phi} (ns)	
									t_{0h}	K_{th}	t_{0hl}	K_{thl}
CMOS-level I/O buffer ICO5R	Refer to equivalent circuit of three-state output.	—	3			D2	E D		2.38	0.017	4.00	0.030
	Refer to equivalent circuit of input buffers.		5						2.18		3.80	
TTL-level I/O buffer with Schmitt-trigger ITS05R	Refer to equivalent circuit of three-state output.	—	3			D2	E D		2.38	0.017	4.00	0.030
	Refer to equivalent circuit of input buffers.		5						2.18		3.80	
CMOS-level I/O buffer with Schmitt-trigger ICS05R	Refer to equivalent circuit of three-state output.	—	3			D2	E D		2.38	0.017	4.00	0.030
	Refer to equivalent circuit of input buffers.		5						2.18		3.80	
Three-state output buffer with pull-up OZ5RU		—	3			D2	E D		2.38	0.017	4.00	0.030
			5						2.18		3.80	
Three-state output buffer with pull-down OZ5RD		—	3			D2	E D		2.38	0.017	4.00	0.030
			5						2.18		3.80	
Open-drain output buffer with pull-up ODN5RU		—	2			D2			(t_{0z}) 3.06	(K_{z}) —	(t_{0zl}) 6.30	(K_{zl}) 0.037
TTL-level I/O buffer with pull-up ITO5RU	Refer to equivalent circuit of three-state output.	—	3			D2	E D		2.38	0.017	4.00	0.030
	Refer to equivalent circuit of input buffers.		5						2.18		3.80	

HG62G Series

• GND noise reduction buffers ($I_{OL} = 24 \text{ mA}$) (cont)

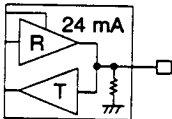
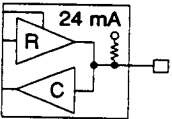
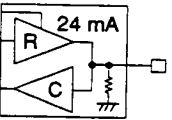
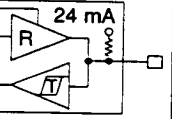
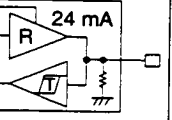
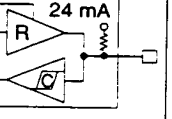
Macro			Clamp Level when Open	Symbol	Sym- bol No.	In- put Name	Out- put Name	Delay			
								t_{plh} (ns)		t_{phl} (ns)	
Function and Macro Name	Equiv. Circuit	Equiv. Gate Count	LV					t_{olh}	K_{lh}	t_{ohl}	K_{hl}
TTL-level I/O buffer with pull-down ITO5RD	Refer to equivalent circuit of three-state output.	—	3		D2	E D		2.38	0.017	4.00	0.030
	2.18							3.80			
	Refer to equivalent circuit of input buffers.		5					0.53	0.16	1.19	0.14
CMOS-level I/O buffer with pull-up ICO5RU	Refer to equivalent circuit of three-state output.	—	3		D2	E D		2.38	0.017	4.00	0.030
	2.18							3.80			
	Refer to equivalent circuit of input buffers.		5					0.65	0.17	0.82	0.14
CMOS-level I/O buffer with pull-down ICO5RD	Refer to equivalent circuit of three-state output.	—	3		D2	E D		2.38	0.017	4.00	0.030
	2.18							3.80			
	Refer to equivalent circuit of input buffers.		5					0.65	0.17	0.82	0.14
TTL-level Schmitt-trigger I/O buffer with pull-up ITSO5RU	Refer to equivalent circuit of three-state output.	—	3		D2	E D		2.38	0.017	4.00	0.030
	2.18							3.80			
	Refer to equivalent circuit of input buffers.		5					0.83	0.22	1.57	0.27
TTL-level Schmitt-trigger I/O buffer with pull-down ITSO5RD	Refer to equivalent circuit of three-state output.	—	3		D2	E D		2.38	0.017	4.00	0.030
	2.18							3.80			
	Refer to equivalent circuit of input buffers.		5					0.83	0.22	1.57	0.27
CMOS-level Schmitt-trigger I/O buffer with pull-up ICSO5RU	Refer to equivalent circuit of three-state output.	—	3		D2	E D		2.38	0.017	4.00	0.030
	2.18							3.80			
	Refer to equivalent circuit of input buffers.		5					0.96	0.26	1.34	0.26





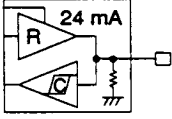



HG62G Series

- GND noise reduction buffers ($I_{OL} = 24 \text{ mA}$) (cont)

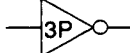
Macro			LV	Clamp Level when Open	Symbol	Sym-bol No.	In-put Name	Out-put Name	Delay			
Function and Macro Name	Equiv. Circuit	Equiv. Gate Count							$t_{plh} \text{ (ns)}$		$t_{phi} \text{ (ns)}$	
									t_{olh}	K_{lh}	t_{ohl}	K_{hl}
CMOS-level Schmitt-trigger I/O buffer with pull-down ICSO5RD	Refer to equivalent circuit of three-state output.	—	3		D2	E	D	2.38	0.017	4.00	0.030	
	Refer to equivalent circuit of input buffers.	5	2.18						3.80			
								0.96	0.26	1.34	0.26	

Note: Propagation delay constant from enable terminals (E) as three-state output responds to $t_{olh} \rightarrow t_{olz}$ or t_{ozh} , and $t_{ohl} \rightarrow t_{ohz}$ or t_{ozl} .

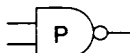
Power Gates

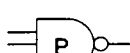
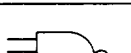
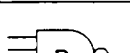
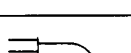
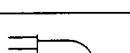
Macro					Symbol	Delay			
Function and Macro Name	Equivalent Circuit	Equiv. Gate Count	LV	Clamp Level when Open		$t_{plh} \text{ (ns)}$		$t_{phi} \text{ (ns)}$	
						t_{olh}	K_{lh}	t_{ohl}	K_{hl}
Power inverter NAP1		1	2	@		0.18	0.30	0.30	0.30
Power inverter NA3P		2	3	@		0.19	0.24	0.31	0.24
Power inverter NA4P		2	4	@		0.20	0.18	0.32	0.18
2-input power NAND NAP2		2	2	@		0.16	0.30	0.20	0.42
3-input power NAND NAP3		3	2	@		0.18	0.30	0.22	0.58
4-input power NAND NAP4		4	2	@		0.20	0.30	0.25	0.70
6-input power NAND NAP6		5	1	@		0.48	0.30	0.85	0.30

Power Gates (cont)

Macro			LV	Clamp Level when Open	Symbol	Delay			
Function and Macro Name	Equivalent Circuit	Equiv. Gate Count				t _{plh} (ns)		t _{phl} (ns)	
						t _{olh}	K _{lh}	t _{ohl}	K _{hl}
8-input power NAND NAP8		7	1	@		0.52	0.30	0.95	0.30
9-input power NAND NAP9		7	1	@		0.52	0.30	0.95	0.30
12-input power NAND NAP-12		9	1	@		0.52	0.30	1.28	0.30
16-input power NAND NAP16		13	1	@		0.52	0.30	0.88	0.42
2-input NOR NRP2		2	2	#		0.28	0.50	0.24	0.30
3-input NOR NRP3		3	2	#		0.30	0.74	0.26	0.30
4-input NOR NRP4		4	2	#		0.32	0.98	0.28	0.30
6-input NOR NRP6		5	1	#		0.74	0.30	0.55	0.30
8-input NOR NRP8		7	1	#		0.90	0.30	0.55	0.30
9-input NOR NRP9		7	1	#		0.90	0.30	0.55	0.30
12-input NOR NRP12		9	1	#		1.02	0.30	0.58	0.30

HG62G Series

Power Gates (cont)

Macro			LV	Clamp Level when Open	Symbol	Delay			
						t _{plh} (ns)		t _{phl} (ns)	
Function and Macro Name	Equivalent Circuit	Equiv. Gate Count				t _{olh}	K _{lh}	t _{ohl}	K _{hl}
16-input NOR NRP16		13	1	#		1.00	0.50	0.62	0.30
Power buffer ANP		2	1	@		0.20	0.30	0.38	0.30
Power buffer AN3P		3	2	@		0.20	0.24	0.34	0.24
Power buffer AN4P		3	2	@		0.22	0.18	0.36	0.18
2-input power AND ANP2		2	1	@		0.46	0.30	0.38	0.30
3-input power AND ANP3		3	1	@		0.50	0.30	0.40	0.30
4-input power AND ANP4		3	1	@		0.58	0.30	0.42	0.30
2-input power OR ORP2		2	1	#		0.52	0.30	0.46	0.30
3-input power OR ORP3		3	1	#		0.57	0.30	0.52	0.30
4-input power OR ORP4		3	1	#		0.64	0.30	0.62	0.30
2-input power EOR EORP		4	2	#		0.37	0.50	0.50	0.42
2-input power ENOR ENRP		4	2	#		0.37	0.50	0.48	0.42

Three-State Power Gates

Function and Macro Name	Macro		LV	Clamp Level when Open	In - put Name	Out - put Name	Delay			
	Equivalent Circuit and Symbol	Equiv. Gate Count					t _{plh} (ns)		t _{phl} (ns)	
							t _{olh}	K _{lh}	t _{ohl}	K _{hl}
3-state power inverter (internal) NAZP		2	0.5	-	D		0.58	0.40	0.44	0.38
			0.5	-	E/E		0.28		0.40	
3-state power buffer (internal) ANZP		4	2	#	D		0.50	0.30	0.40	0.30
			2	@	E		0.60		0.50	

Gates







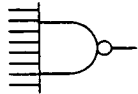
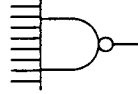
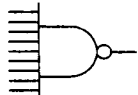
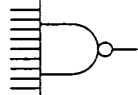
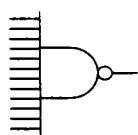
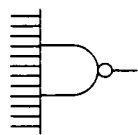
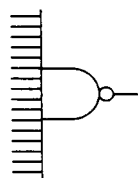
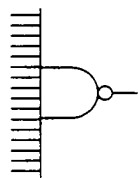
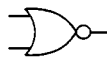
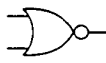
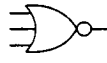
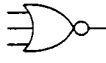
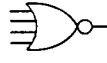
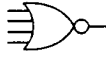
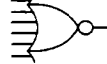
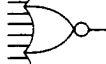
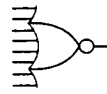
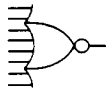
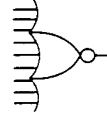
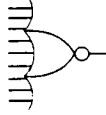

Macro			LV	Clamp Level when Open	Symbol	Delay				
Function and Macro Name	Equivalent Circuit	Equiv. Gate Count				t _{plh} (ns)		t _{phl} (ns)		
						t _{olh}	K _{lh}	t _{ohl}	K _{hl}	
Inverter NA1		1	1	@			0.16	0.50	0.28	0.50
2-input NAND NA2		1	1	@			0.18	0.50	0.30	0.76
3-input NAND NA3		2	1	@			0.22	0.50	0.32	1.08
4-input NAND NA4		2	1	@			0.24	0.50	0.34	1.36
6-input NAND NA6		5	1	@			0.38	0.50	0.75	0.50

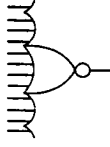
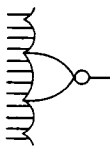
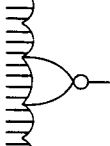
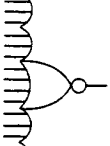
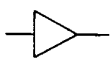
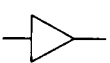
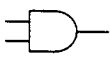
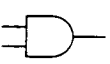
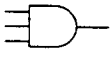
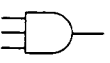
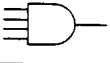
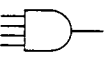
HG62G Series

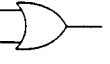
Gates (cont)

Macro			LV	Clamp Level when Open	Symbol	Delay			
Function and Macro Name	Equivalent Circuit	Equiv. Gate Count				t _{plh} (ns)		t _{phl} (ns)	
						t _{olh}	K _{Ih}	t _{ohl}	K _{hl}
8-input NAND NA8		6	1	@		0.42	0.50	0.85	0.50
9-input NAND NA9		7	1	@		0.42	0.50	0.85	0.50
12-input NAND NA12		8	1	@		0.42	0.50	1.18	0.50
16-input NAND NA16		11	1	@		0.42	0.50	0.78	0.76
2-input NOR NR2		1	1	#		0.20	0.92	0.38	0.50
3-input NOR NR3		2	1	#		0.22	1.34	0.43	0.50
4-input NOR NR4		2	1	#		0.24	1.80	0.50	0.50
6-input NOR NR6		5	1	#		0.64	0.50	0.45	0.50
8-input NOR NR8		6	1	#		0.80	0.50	0.45	0.50
9-input NOR NR9		7	1	#		0.80	0.50	0.45	0.50

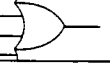
Gates (cont)

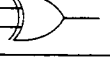
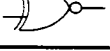
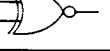
Macro			LV	Clamp Level when Open	Symbol	Delay			
Function and Macro Name	Equivalent Circuit	Equiv. Gate Count				t _{plh} (ns)		t _{phl} (ns)	
						t _{olh}	K _{lh}	t _{ohl}	K _{hl}
12-input NOR NR12		8	1	#		0.92	0.50	0.48	0.50
16-input NOR NR16		11	1	#		0.90	0.92	0.52	0.50
Buffer AN1		1	1	@		0.34	0.50	0.26	0.50
2-input AND AN2		2	1	@		0.36	0.50	0.28	0.50
3-input AND AN3		2	1	@		0.40	0.50	0.30	0.50
4-input AND AN4		3	1	@		0.48	0.50	0.32	0.50
2-input OR OR2		2	1	#		0.42	0.50	0.36	0.50
3-input OR OR3		2	1	#		0.47	0.50	0.42	0.50
4-input OR OR4		3	1	#		0.54	0.50	0.52	0.50
2-input EOR EOR		3	2	#		0.27	0.92	0.40	0.76
2-input ENOR ENR		3	2	#		0.27	0.92	0.38	0.76

HG62G Series

Three-State Gates

Macro			Delay							
Function and Macro Name	Equivalent Circuit and Symbol	Equiv. Gate Count	LV	Clamp Level when Open	In - put Name	Out - put Name	t_{plh} (ns)		t_{phi} (ns)	
							t_{olh}	K_{lh}	t_{ohl}	K_{hl}
3-state inverter (internal) NAZ		1	0.5 0.5 1	@	D		0.48	0.65	0.34	0.62
					E/E		0.18		0.30	
3-state buffer (internal) ANZ		3	2 2	# @	D		0.40	0.50	0.30	0.50
					E		0.50		0.40	

AND-NOR, OR-NAND Power Gates

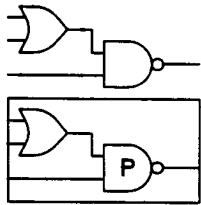
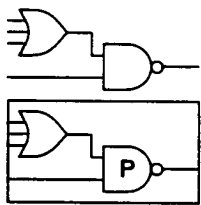
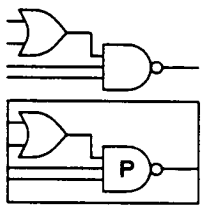
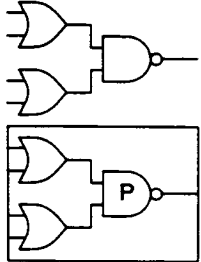
Macro			LV	Clamp Level when Open	Sym - bol No.	In - put Name	Out - put Name	Delay			
Function and Macro Name	Equiv. Circuit and Symbol	Equiv. Gate Count						t _{plh} (ns)		t _{phl} (ns)	
								t _{olh}	K _{lh}	t _{ohl}	K _{hl}
2-OR NAND NAR23P		3	2	# # @	A1	OR		0.33	0.50	0.48	0.42
						NAND		0.33		0.48	
3-OR NAND NAR34P		4	2	# # # @	A2	OR		0.40	0.74	0.48	0.42
						NAND		0.40		0.48	
2-OR 3-NAND NAR24P		4	2	# # @ @	A2	OR		0.40	0.50	0.48	0.58
						NAND		0.40		0.48	
2-wide, 2-input OR- NAND NA2R2P		4	2	# # # #	A1			0.40	0.50	0.53	0.42

HG62G Series

AND-NOR, OR-NAND Power Gates (cont)

Function and Macro Name	Macro Equiv. Circuit and Symbol	Equiv. Gate Count	LV	Clamp Level when Open	Sym - bol No.	In - put Name	Out - put Name	Delay			
								t _{plh} (ns)		t _{phl} (ns)	
								t _{olh}	K _{lh}	t _{ohl}	K _{hl}
3-wide, 2-input OR-NAND NA3R2P		6	2	# # # # #	A3			0.42	0.50	0.60	0.58
2-wide, 3-input OR-NAND NA2R3NP		7	2	# # # # #	A2		+Y	0.72	0.30	0.97	0.30
							-Y	0.77	0.74	0.57	0.42
2-wide, 4-input OR-NAND NA2R4NP		9	2	# # # # #	A4		+Y	0.72	0.30	1.00	0.30
							-Y	0.80	0.98	0.57	0.42

AND-NOR, OR-NAND Power Gates (cont)

Macro		Equiv. Gate Count	LV	Clamp Level when Open	Sym- bol No.	In- put Name	Out- put Name	Delay			
Function and Macro Name	Equiv. Circuit and Symbol							t _{ph} (ns)		t _{pl} (ns)	
								t _{oh}	K _{th}	t _{ohl}	K _{hl}
3-wide, 3-input OR-NAND NA3R3NP		10	2	# # # # # # # #			+Y	0.79	0.30	1.00	0.30
							-Y	0.80	0.74	0.64	0.58
3-wide, 4-input OR-NAND NA3R4NP		13	2	# # # # # # # #			+Y	0.79	0.30	1.28	0.30
							-Y	1.08	0.98	0.64	0.58

HG62G Series

AND-NOR, OR-NAND Power Gates (cont)

Macro			LV	Clamp Level when Open	Sym- bol No.	Delay					
Function and Macro Name	Equiv. Circuit and Symbol	Equiv. Gate Count				In- put Name	Out- put Name	t _{pth} (ns)		t _{phi} (ns)	
								t _{oH}	K _H	t _{oL}	K _L
4-wide, 2-input OR-NAND NA4R2NP		10	2	@ @ @ @ @ @ @ @	A4		+Y	0.75	0.30	0.77	0.30
							-Y	0.57	0.50	0.60	0.70
4-wide, 3-input OR-NAND NA4R3NP		13	2	# # # # # # # # # #			+Y	0.95	0.30	1.28	0.30
							-Y	1.08	0.74	0.80	0.70

AND-NOR, OR-NAND Power Gates (cont)

Function and Macro Name	Macro		LV	Clamp Level when Open	Sym - bol No.	In - put Name	Out - put Name	Delay			
	Equiv. Circuit and Symbol	Equiv. Gate Count						t _{plh} (ns)		t _{phl} (ns)	
								t _{olh}	K _{lh}	t _{ohl}	K _{hl}
3-AND-NOR NRA34P		4	2	@ @ @ #	A2	AND		0.37	0.50	0.50	0.58
						NOR		0.36		0.50	
2-AND-3-NOR NRA24P		4	2	@ @ # #	A2	AND		0.38	0.74	0.50	0.42
						NOR		0.38		0.50	
2-wide 2-input AND-NOR NR2A2P		4	2	@ @ @ @	A1			0.40	0.50	0.53	0.42
3-wide 2-input AND-NOR NR3A2P		6	2	@ @ @ @ @ @	A3			0.46	0.74	0.60	0.42

HG62G Series

AND-NOR, OR-NAND Power Gates (cont)

Function and Macro Name	Macro		LV	Clamp Level when Open	Sym - bol No.	In - put Name	Out - put Name	Delay			
	Equiv. Circuit and Symbol	Equiv. Gate Count						t_{plh} (ns)		t_{phi} (ns)	
								t_{oth}	K_{th}	t_{ohl}	K_{hl}
2-wide 3-input AND- NOR NR2A3NP		7	2	@ @ @ @ @ @ @	A2		+Y	1.05	0.30	0.60	0.30
							-Y	0.40	0.50	0.90	0.58
2-wide 4-input AND- NOR NR2A4NP		9	2	@ @ @ @ @ @ @ @ @	A4		+Y	1.05	0.30	0.60	0.30
							-Y	0.40	0.50	0.90	0.70
3-wide 3-input AND- NOR NR3A3NP		10	2	@ @ @ @ @ @ @ @ @			+Y	1.08	0.30	0.80	0.30
							-Y	0.60	0.74	0.93	0.58

AND-NOR, OR-NAND Power Gates (cont)

Function and Macro Name	Macro		LV	Clamp Level when Open	Sym - bol No.	In - put Name	Out - put Name	Delay			
	Equiv. Circuit and Symbol	Equiv. Gate Count						t _{plh} (ns)		t _{phl} (ns)	
								t _{oth}	K _{ih}	t _{ohl}	K _{hl}
6-wide 2-input AND-NOR NR6A2NP		9	1	# # # # # # # #			+Y	0.80	0.30	0.75	0.30
							-Y	0.90	0.30	1.00	0.30

HG62G Series

AND-NOR, OR-NAND Power Gates (cont)

Function and Macro Name	Macro		LV	Clamp Level when Open	Sym - bol No.	In - put Name	Out - put Name	Delay			
	Equiv. Circuit and Symbol	Equiv. Gate Count						t_{ph} (ns)		t_{pl} (ns)	
								t_{oth}	K_{th}	t_{ohl}	K_{hl}
8-wide 2-input AND-NOR NR8A2NP		12	1	# # # # # # # # # # # #	A5		+Y	0.90	0.30	1.08	0.30
							-Y	0.88	0.30	0.75	0.30

AND-NOR, OR-NAND Power Gates (cont)

Function and Macro Name	Macro		LV	Clamp Level when Open	Sym- bol No.	Delay					
	Equiv. Circuit and Symbol	Equiv. Gate Count				In- put Name	Out- put Name	t _{plh} (ns)		t _{phl} (ns)	
								t _{oLh}	K _{Lh}	t _{oHl}	K _{Hl}
2-OR-AND-NOR NRAR24P		4	2	# # @ #	A1	OR		0.56	0.74	0.54	0.42
						AND		0.50		0.48	
						NOR		0.40		0.42	
2-to-1 multiplexer M2T1NP		6	2 2 2	# # #	B2	Y0	+Y	0.83	0.30	0.55	0.30
						Y1		0.83		0.55	
						S		0.98		0.88	
						Y0	-Y	0.40	0.50	0.63	0.42
						Y1		0.40		0.63	
						S		0.73		0.78	
4-to-1 multiplexer M4T1NP		15	1 1 2 2 2 2	# # # # # #	B4	Y0	+Y	1.20	0.30	0.82	0.30
						Y1		1.20		0.82	
						Y2		1.20		0.82	
						Y3		1.20		0.82	
						A		1.40		1.25	
						B		1.40		1.25	
						Y0	-Y	0.67	0.98	1.00	0.58
						Y1		0.67		1.00	
						Y2		0.67		1.00	
						Y3		0.67		1.00	
						A		1.10		1.20	
						B		1.10		1.20	

HG62G Series

AND-NOR, OR-NAND Power Gates (cont)

Macro		Equiv. Gate Count	LV	Clamp Level when Open	Sym- bol No.	Delay									
Function and Macro Name	Equiv. Circuit and Symbol					t _{plh} (ns)		t _{phl} (ns)							
						t _{o1h}	K _{th}	t _{o1l}	K _{tl}						
8-to-1 multiplexer M8T1NP		23	1	# # # # # # # #	B6	Y0-	+Y	1.37	0.30	1.30	0.58				
						Y7		2.10		1.83					
						A									
							B								
							C								
						Y0-	-Y	1.45	0.30	1.57	0.30				
						Y7		1.98		2.30					
						A									
B															
	C														
1-to-2 demultiplexer M1T2NP		7	2 4	# @	B3	Y	+0	0.62	0.30	0.63	0.30				
						A		0.69		0.70					
						Y	+1	0.62	0.30	0.63	0.30				
						A		0.62		0.63					
						Y	-0	0.43	0.30	0.47	0.42				
						A		0.50		0.54					
						Y	-1	0.43	0.30	0.47	0.42				
						A		0.43		0.47					

AND-NOR, OR-NAND Gates (Normal)

Function and Macro Name	Macro		LV	Clamp Level when Open	Sym- bol No.	In- put Name	Out- put Name	Delay			
	Equiv. Circuit and Symbol	Equiv. Gate Count						t_{plh} (ns)		t_{phi} (ns)	
								t_{oH}	K_{th}	t_{oH}	K_{nl}
2-OR NAND NAR23		2	1	# # @	A1	OR		0.23	0.92	0.38	0.76
						NAND		0.23		0.38	
3-OR NAND NAR34		2	1	# # # @	A2	OR		0.30	1.34	0.38	0.76
						NAND		0.30		0.38	
2-OR 3-NAND NAR24		2	1	# # @ @	A2	OR		0.30	0.92	0.38	1.08
						NAND		0.30		0.38	
2-wide, 2-input OR- NAND NA2R2		2	1	# # # #	A1			0.30	0.92	0.43	0.76

HG62G Series

AND-NOR, OR-NAND Gates (Normal) (cont)

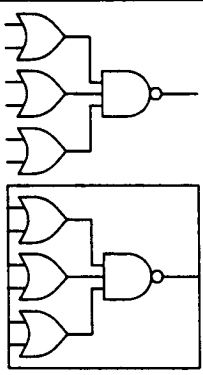
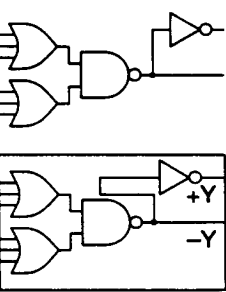
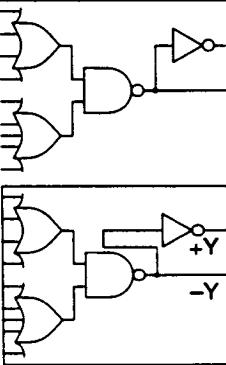
Function and Macro Name	Macro Equiv. Circuit and Symbol	Equiv. Gate Count	LV	Clamp Level when Open	Sym - bol No.	In - put Name	Out - put Name	Delay			
								t _{ph} (ns)		t _{pl} (ns)	
								t _{olh}	K _{Ih}	t _{ohl}	K _{hl}
3-wide, 2-input OR-NAND NA3R2		3	1	# # # # #	A3			0.32	0.92	0.50	1.08
2-wide, 3-input OR-NAND NA2R3N		4	1	# # # # #	A2		+Y	0.62	0.50	0.87	0.50
							-Y	0.67	1.34	0.47	0.76
2-wide, 4-input OR-NAND NA2R4N		5	1	# # # # #	A4		+Y	0.62	0.50	0.90	0.50
							-Y	0.70	1.80	0.47	0.76

AND-NOR, OR-NAND Gates (Normal) (cont)

Function and Macro Name	Macro Equiv. Circuit and Symbol	Equiv. Gate Count	LV	Clamp Level when Open	Sym - bol No.	In - put Name	Out - put Name	Delay			
								t _{plh} (ns)		t _{phi} (ns)	
								t _{olh}	K _{th}	t _{ohl}	K _{hl}
3-wide, 3-input OR-NAND NA3R3N		5	1	# # # # # # #			+Y	0.69	0.50	0.90	0.50
							-Y	0.70	1.34	0.54	1.08
3-wide, 4-input OR-NAND NA3R4N		7	1	# # # # # # # #			+Y	0.69	0.50	1.18	0.50
							-Y	0.98	1.80	0.54	1.08

HG62G Series

AND-NOR, OR-NAND Gates (Normal) (cont)

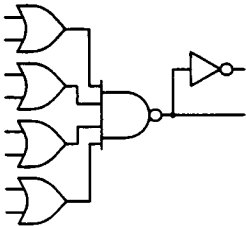
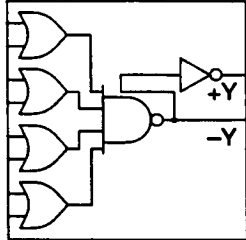
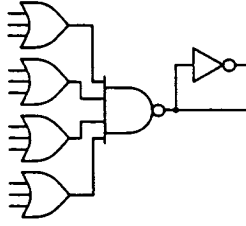
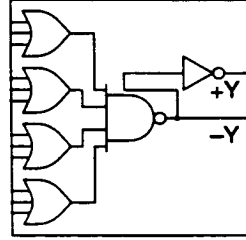
Function and Macro Name	Macro Equiv. Circuit and Symbol	Equiv. Gate Count	LV	Clamp Level when Open	Sym- bol No.	In- put Name	Out- put Name	Delay			
								t _{plh} (ns)		t _{phl} (ns)	
								t _{oLh}	K _M	t _{oHl}	K _{HL}
4-wide, 2-input OR-NAND NA4R2N	 	5	1	@ @ @ @ @ @ @ @	A4		+Y	0.65	0.50	0.67	0.50
							-Y	0.47	0.92	0.50	1.36
4-wide, 3-input OR-NAND NA4R3N	 	7	1	# # # # # # # # # #			+Y	0.85	0.50	1.18	0.50
							-Y	0.98	1.34	0.70	1.36

AND-NOR, OR-NAND Gates (Normal) (cont)

Function and Macro Name	Macro		LV	Clamp Level when Open	Sym - bol No.	In - put Name	Out - put Name	Delay			
	Equiv. Circuit and Symbol	Equiv. Gate Count						t _{plh} (ns)		t _{phl} (ns)	
								t _{oH}	K _H	t _{oL}	K _L
4-wide, 4-input OR-NAND NA4R4N		9	1	# # # # # # # # # # #	A5		+Y	0.92	0.50	1.47	0.50
							-Y	1.27	1.80	0.77	1.36
6-wide, 2-input OR-NAND NA6R2N		8	1	@ @ @ @ @ @ @ @ @ @ @ @			+Y	0.60	0.92	0.57	0.50
							-Y	0.72	0.50	0.80	0.50

AND-NOR, OR-NAND Gates (Normal) (cont)

Function and Macro Name	Macro		LV	Clamp Level when Open	Sym - bol No.	In - put Name	Out - put Name	Delay			
	Equiv. Circuit and Symbol	Equiv. Gate Count						t _{plh} (ns)		t _{phl} (ns)	
								t _{olh}	K _{th}	t _{ohl}	K _{hl}
3-AND-NOR NRA34		2	1	@ @ @ #	A2	AND NOR		0.27	0.92	0.40	1.08
								0.26		0.40	
2-AND-3-NOR NRA24		2	1	@ @ # #	A2	AND NOR		0.28	1.34	0.40	0.76
								0.28		0.40	
2-wide, 2-input AND-NOR NR2A2		2	1	@ @ @ @	A1			0.30	0.92	0.43	0.76
3-wide, 2-input AND-NOR NR3A2		3	1	@ @ @ @ @	A3			0.36	1.34	0.50	0.76

HG62G Series

AND-NOR, OR-NAND Gates (Normal) (cont)

Function and Macro Name	Macro		LV	Clamp Level when Open	Sym - bol No.	Delay					
	Equiv. Circuit and Symbol	Equiv. Gate Count				In - put Name	Out - put Name	t _{plh} (ns)		t _{phi} (ns)	
								t _{o1h}	K _{1h}	t _{o1l}	K _{1l}
2-wide, 3-input AND-NOR NR2A3N		4	1	@ @ @ @ @ @	A2		+Y	0.95	0.50	0.50	0.50
							-Y	0.30	0.92	0.80	1.08
2-wide, 4-input AND-NOR NR2A4N		5	1	@ @ @ @ @ @ @ @ @	A4		+Y	0.98	0.50	0.60	0.50
							-Y	0.40	0.92	0.83	1.36
3-wide, 3-input AND-NOR NR3A3N		5	1	@ @ @ @ @ @ @ @ @			+Y	0.98	0.50	0.70	0.50
							-Y	0.50	1.34	0.83	1.08

AND-NOR, OR-NAND Gates (Normal) (cont)

Function and Macro Name	Macro		LV	Clamp Level when Open	Sym- bol No.	In- put Name	Out- put Name	Delay			
	Equiv. Circuit and Symbol	Equiv. Gate Count						t _{pth} (ns)		t _{phi} (ns)	
								t _{oth}	K _{th}	t _{ohl}	K _{hl}
3-wide 4-input AND-NOR NR3A4N		7	1	@			+Y	1.05	0.50	0.90	0.50
							-Y	0.70	1.34	0.90	1.36
4-wide 2-input AND-NOR NR4A2N		5	1	#	A4		+Y	0.72	0.50	0.67	0.50
							-Y	0.47	1.80	0.57	0.76

AND-NOR, OR-NAND Gates (Normal) (cont)

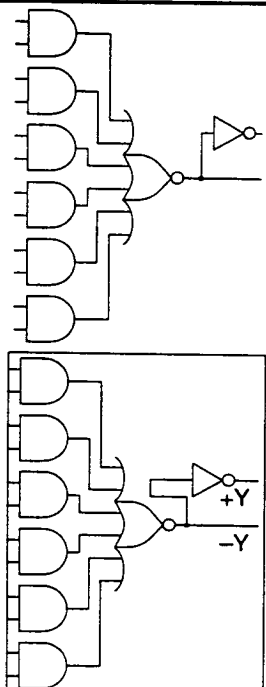
Function and Macro Name	Macro		LV	Clamp Level when Open	Sym-bol No.	In-put Name	Out-put Name	Delay			
	Equiv. Circuit and Symbol	Equiv. Gate Count						t _{plh} (ns)		t _{phl} (ns)	
								t _{olh}	K _{lh}	t _{ohl}	K _{hl}
6-wide 2-input AND-NOR NR6A2N		8	1	# # # # # # # #			+Y	0.70	0.50	0.65	0.50
							-Y	0.80	0.50	0.90	0.50

HG62G Series

AND-NOR, OR-NAND Gates (Normal) (cont)

Function and Macro Name	Macro		LV	Clamp Level when Open	Sym - bol No.	Delay					
	Equiv. Circuit and Symbol	Equiv. Gate Count				t _{plh} (ns)		t _{phl} (ns)			
						t _{o1h}	K _{1h}	t _{o1l}	K _{1l}		
8-wide 2-input AND-NOR NR8A2N		10	1	# # # # # # # # # # #	A5	+Y	0.80	0.50	0.98	0.50	
						-Y	0.78	0.50	0.65	0.50	

AND-NOR, OR-NAND Gates (Normal) (cont)

Macro				Delay							
Function and Macro Name	Equiv. Circuit and Symbol	Equiv. Gate Count	LV	Clamp Level when Open	Symbol No.	In-put Name	Out-put Name	t_{plh} (ns)		t_{phi} (ns)	
								t_{olh}	K_{th}	t_{ohl}	K_{hl}
2-OR-AND-NOR NRAR24		2	1	# # @ #	A1	OR		0.46	1.34	0.44	0.76
						AND		0.40		0.38	
						NOR		0.30		0.32	
2-to-1 multiplexer M2T1N		3	2 1 1	# # #	B2	Y0	+Y	0.73	0.50	0.45	0.50
						Y1	+Y	0.73		0.45	
						S	+Y	0.88		0.78	
						Y0	-Y	0.30	0.92	0.53	0.76
						Y1	-Y	0.30		0.53	
						S	-Y	0.63		0.68	
4-to-1 multiplexer M4T1N		9	1	# # # # # #	B4	Y0	+Y	1.10	0.50	0.72	0.50
						Y1	+Y	1.10		0.72	
						Y2	+Y	1.10		0.72	
						Y3	+Y	1.10		0.72	
						A	+Y	1.30		1.15	
						B	+Y	1.30		1.15	
						Y0	-Y	0.57	1.80	0.90	1.08
						Y1	-Y	0.57		0.90	
						Y2	-Y	0.57		0.90	
						Y3	-Y	0.57		0.90	
						A	-Y	1.00		1.10	
						B	-Y	1.00		1.10	

HG62G Series

AND-NOR, OR-NAND Gates (Normal) (cont)

Macro		Equiv. Gate Count	LV	Clamp Level when Open	Sym- bol No.	Delay					
Function and Macro Name	Equiv. Circuit and Symbol					In- put Name	Out- put Name	t _{ph} (ns)		t _{pl} (ns)	
								t _{oH}	K _H	t _{oL}	K _L
8-to-1 multiplexer M8T1N		21	1	# # # # # # # #	B6	Y0- Y7	+Y	1.27	0.50	1.20	1.08
								A	2.00		1.73
								B			
								C			
						Y0- Y7	-Y	1.35	0.50	1.47	0.50
								A	1.88		2.20
								B			
								C			
1-to-2 demultiplexer M1T2N		4	2	# @	B3	Y	+0	0.52	0.50	0.53	0.50
								A	0.59		0.60
						Y	+1	0.52	0.50	0.53	0.50
								A	0.52		0.53
						Y	-0	0.33	0.50	0.37	0.76
								A	0.40		0.44
						Y	-1	0.33	0.50	0.37	0.76
								A	0.33		0.37

Power Decoders

Macro				Delay							
Function and Macro Name	Equiv. Circuit and Symbol	Equiv. Gate Count	LV	Clamp Level when Open	Sym-bol No.	In-put Name	Out-put Name	t_{plh} (ns)		t_{phi} (ns)	
								t_{oH}	K_{th}	t_{oH}	K_{Hl}
2-bit decoder D2T4NP		14	1	# #	B5	A	-0	0.58	0.30	0.62	0.42
						B		0.58		0.62	
						A	-1	0.70	0.30	0.80	0.42
						B		0.58		0.62	
						A	-2	0.58	0.30	0.62	0.42
						B		0.70		0.80	
						A	-3	0.70	0.30	0.80	0.42
						B		0.70		0.80	
						A	+0	0.77	0.30	0.78	0.30
						B		0.77		0.78	
						A	+1	0.95	0.30	0.90	0.30
						B		0.77		0.78	
						A	+2	0.77	0.30	0.78	0.30
						B		0.95		0.90	
						A	+3	0.95	0.30	0.90	0.30
						B		0.95		0.90	
3-bit decoder D3T8P		26	9	# # #	B5	A, B, C	-0 to -7	0.68	0.30	0.62	0.58

HG62G Series

Decoders (Normal)

Function and Macro Name	Macro		LV	Clamp Level when Open	Sym- bol No.	Delay					
	Equiv. Circuit and Symbol	Equiv. Gate Count				In- put Name	Out- put Name	t_{ph} (ns)		t_{pl} (ns)	
								t_{oh}	K_{th}	t_{oh}	K_{pl}
2-bit decoder D2T4N		8	1	# #	B5	A	-0	0.48	0.50	0.52	0.76
						B		0.48		0.52	
						A	-1	0.60	0.50	0.70	0.76
						B		0.48		0.52	
						A	-2	0.48	0.50	0.52	0.76
						B		0.60		0.70	
						A	-3	0.60	0.50	0.70	0.76
						B		0.60		0.70	
						A	+0	0.67	0.50	0.68	0.50
						B		0.67		0.68	
						A	+1	0.85	0.50	0.80	0.50
						B		0.67		0.68	
						A	+2	0.67	0.50	0.68	0.50
						B		0.85		0.80	
						A	+3	0.85	0.50	0.80	0.50
						B		0.85		0.80	
3-bit decoder D3T8		14	5	# # #	B5	A, B, C	-0 to -7	0.58	0.50	0.52	1.08

Latches (with Scan Function)

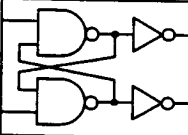
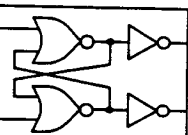
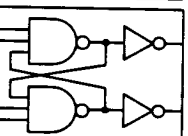
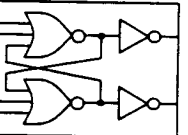
Function and Macro Name	Macro		LV	Clamp Level when Open	Sym - bol No.	Delay																									
	Equiv. Circuit and Symbol	Equiv. Gate Count				In - put Name	Out - put Name	t_{plh} (ns)		t_{phi} (ns)																					
								t_{o1h}	K_{th}	t_{o1l}	K_{pl}																				
RS latch TLRS0	<table border="1"> <tr><th>SN</th><th>RN</th><th>+Q</th><th>-Q</th></tr> <tr><td>0</td><td>0</td><td>0</td><td>0</td></tr> <tr><td>0</td><td>1</td><td>1</td><td>0</td></tr> <tr><td>1</td><td>0</td><td>0</td><td>1</td></tr> <tr><td>1</td><td>1</td><td colspan="2">Latch</td></tr> </table> 	SN	RN	+Q	-Q	0	0	0	0	0	1	1	0	1	0	0	1	1	1	Latch		9	1	@ @	A3	S	+Q	1.30	0.50	—	0.42
		SN	RN	+Q	-Q																										
		0	0	0	0																										
		0	1	1	0																										
		1	0	0	1																										
1	1	Latch																													
R		1.16		1.00																											
S	-Q	1.16	0.50	1.00	0.42																										
R		1.30		—																											
RS latch TLRS3	<table border="1"> <tr><th>S</th><th>R</th><th>+Q</th><th>-Q</th></tr> <tr><td>0</td><td>0</td><td colspan="2">Latch</td></tr> <tr><td>0</td><td>1</td><td>0</td><td>1</td></tr> <tr><td>1</td><td>0</td><td>1</td><td>0</td></tr> <tr><td>1</td><td>1</td><td>1</td><td>1</td></tr> </table> 	S	R	+Q	-Q	0	0	Latch		0	1	0	1	1	0	1	0	1	1	1	1	9	1	# #	A3	S	+Q	1.00	0.50	1.30	0.42
		S	R	+Q	-Q																										
		0	0	Latch																											
		0	1	0	1																										
		1	0	1	0																										
1	1	1	1																												
R		—		1.37																											
S	-Q	—	0.50	1.37	0.42																										
R		1.00		1.30																											
2-input RS latch TLR2S20	<table border="1"> <tr><th>SN</th><th>RN</th><th>+Q</th><th>-Q</th></tr> <tr><td>0</td><td>0</td><td>0</td><td>0</td></tr> <tr><td>0</td><td>1</td><td>1</td><td>0</td></tr> <tr><td>1</td><td>0</td><td>0</td><td>1</td></tr> <tr><td>1</td><td>1</td><td colspan="2">Latch</td></tr> </table> 	SN	RN	+Q	-Q	0	0	0	0	0	1	1	0	1	0	0	1	1	1	Latch		10	1	@ @ @ @	A4	S	+Q	1.37	0.50	—	0.42
		SN	RN	+Q	-Q																										
		0	0	0	0																										
		0	1	1	0																										
		1	0	0	1																										
1	1	Latch																													
R		1.30		1.05																											
S	-Q	1.30	0.50	1.05	0.42																										
R		1.37		—																											
2-input RS latch TLR2S23	<table border="1"> <tr><th>S</th><th>R</th><th>+Q</th><th>-Q</th></tr> <tr><td>0</td><td>0</td><td colspan="2">Latch</td></tr> <tr><td>0</td><td>1</td><td>0</td><td>1</td></tr> <tr><td>1</td><td>0</td><td>1</td><td>0</td></tr> <tr><td>1</td><td>1</td><td>1</td><td>1</td></tr> </table> 	S	R	+Q	-Q	0	0	Latch		0	1	0	1	1	0	1	0	1	1	1	1	10	1	# #	A4	S	+Q	1.05	0.50	1.37	0.42
		S	R	+Q	-Q																										
		0	0	Latch																											
		0	1	0	1																										
		1	0	1	0																										
1	1	1	1																												
R		—		1.51																											
S	-Q	—	0.50	1.51	0.42																										
R		1.05		1.37																											

HG62G Series

Latches (with Scan Function) (cont)

Macro			Delay								
Function and Macro Name	Equiv. Circuit and Symbol	Equiv. Gate Count	LV	Clamp Level when Open	Symbol No.	In-put Name	Out-put Name	t_{plh} (ns)		t_{phi} (ns)	
								t_{olh}	K_{lh}	t_{ohl}	K_{hl}
D Latch TLD		6	1	@	C	G	+Q	1.20	0.30	1.20	0.30
						D		1.20		1.20	
						G	-Q	1.00	0.30	1.05	0.30
						D		1.00		1.05	
D Latch with CLR TLDC1	<p>X: Don't care</p>	7	1	@	C	G	+Q	1.30	0.30	1.20	0.30
						D		1.30		1.20	
						CL		0.85		0.80	
						G	-Q	1.00	0.30	1.15	0.30
						D		1.00		1.15	
						CL		0.60		0.70	
D Latch with PRE TLDP1	<p>X: Don't care</p>	7	1	@	C	G	+Q	1.20	0.30	1.30	0.30
						D		1.20		1.30	
						PR		0.95		1.05	
						G	-Q	1.10	0.30	1.05	0.30
						D		1.10		1.05	
						PR		0.85		0.80	
D Latch with CLR/PRE TLDPC3	<p>X: Don't care</p>	8	1	@	C	G	+Q	1.40	0.30	1.40	0.30
						D		1.40		1.40	
						PR		1.10		0.95	
						CL		0.85		0.80	
						G	-Q	1.20	0.30	1.25	0.30
						D		1.20		1.25	
						PR		0.75		0.95	
						CL		0.60		0.70	

Latches (with Scan Function) (cont)

Macro			Equiv. Gate Count	LV	Clamp Level when Open	Sym- bol No.	Delay					
Function and Macro Name	Equiv. Circuit and Symbol	In- put Name					Out- put Name	t _{plh} (ns)		t _{phl} (ns)		
								t _{olh}	K _{lh}	t _{ohl}	K _{hl}	
4-bit latch TLD4	G +Q0 +Q1 +Q2 +Q3	21	1	@	B4	G	+Q0- +Q3	1.12	0.30	1.28	0.30	
	1 D0 D1 D2 D3							1.02		1.07		
	Latch											
	TLD4											
	G D0 +Q0 D1 +Q1 D2 +Q2 D3 +Q3											
4-bit latch with CLR TLD4C1	G CL +Q0 +Q1 +Q2 +Q3	27	1	@	B4	G	+Q0- +Q3	1.12	0.30	1.28	0.30	
	1 0 D0 D1 D2 D3							1.12		1.07		
	Latch											
	X 1 0 0 0 0							1.00		1.05		
	TLD4C1 G D0 +Q0 D1 +Q1 D2 +Q2 D3 +Q3 CL											

Flip-Flops (with Scan Function)

Macro			Equiv. Gate Count	LV	Clamp Level when Open	Sym- bol No.	Delay					
Function and Macro Name	Equiv. Circuit and Symbol	In- put Name					Out- put Name	t _{plh} (ns)		t _{phl} (ns)		
								t _{olh}	K _{lh}	t _{ohl}	K _{hl}	
D flip-flop TFD	CK +Q -Q	8	1	@	C	CK	+Q	1.24	0.30	1.30	0.30	
	D D							1.10	0.30	1.09	0.30	
	+Q0 -Q0			@			-Q					
	TFD CK +Q D -Q											

HG62G Series

Flip-Flops (with Scan Function) (cont)

Function and Macro Name	Macro		Equiv. Gate Count	LV	Clamp Level when Open	Symbol No.	Delay								
	Equiv. Circuit and Symbol	In - put Name					Out - put Name	t_{ph} (ns)		t_{phi} (ns)					
								t_{olh}	K_{lh}	t_{ohl}	K_{hl}				
D flip-flop with Load TFDL1	CK	L	+Q	-Q	10	1	@	C	CK	+Q	1.24	0.30	1.30	0.30	
		0	DC	DC						-Q	1.10	0.30	1.09	0.30	
		1	DL	DL											
		X	+Q0	-Q0											
D flip-flop with CLR TFDC1	CK	CL	+Q	-Q	9	1	@	C	CK	+Q	1.34	0.30	1.30	0.30	
		0	D	D					CL		—		0.87		
		0	+Q0	-Q0					CK	-Q	1.10	0.30	1.19	0.30	
	X	1	0	1					CL		0.67		—		
D flip-flop with PRE TFDP1	CK	PR	+Q	-Q	9	1	@	C	CK	+Q	1.26	0.30	1.35	0.30	
		0	D	D					PR		1.02		—		
		0	+Q0	-Q0					CK	-Q	1.15	0.30	1.11	0.30	
	X	1	1	0					PR		—		0.87		
D flip-flop with CLR/PRE TFDPC3	CK	PR	CL	+Q	-Q	10	1	@	C	CK	+Q	1.26	0.30	1.35	0.30
		0	0	D	D					CL		0.94		0.87	
		0	0	+Q0	-Q0					PR		1.16		—	
	X	1	0	1	0					CK	-Q	1.15	0.30	1.11	0.30
	X	0	1	0	1					CL		0.67		0.79	
	X	1	1	0	1					PR		—		1.01	

Flip-Flops (with Scan Function) (cont)

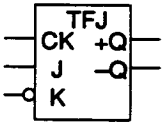
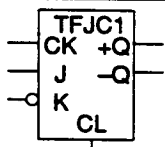
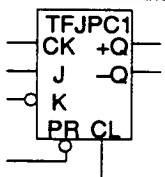
Function and Macro Name	Macro		LV	Clamp Level when Open	Sym- bol No.	Delay																																																																				
	Equiv. Circuit and Symbol	Equiv. Gate Count				t _{plh} (ns)		t _{phl} (ns)																																																																		
						In- put Name	Out- put Name	t _{0th}	K _{th}	t _{0hl}	K _{hl}																																																															
JK flip-flop TFJ	<table border="1"> <tr><th>CK</th><th>J</th><th>K</th><th>+Q</th><th>-Q</th></tr> <tr><td>↗</td><td>0</td><td>0</td><td>0</td><td>1</td></tr> <tr><td>↗</td><td>1</td><td>1</td><td>1</td><td>0</td></tr> <tr><td>↗</td><td>0</td><td>1</td><td>+Q0</td><td>-Q0</td></tr> <tr><td>↗</td><td>1</td><td>0</td><td>-Q0</td><td>+Q0</td></tr> <tr><td>↘</td><td>X</td><td>X</td><td>+Q0</td><td>-Q0</td></tr> </table> 	CK	J	K	+Q	-Q	↗	0	0	0	1	↗	1	1	1	0	↗	0	1	+Q0	-Q0	↗	1	0	-Q0	+Q0	↘	X	X	+Q0	-Q0	11	2 1 1	@ @ #	C	CK	+Q	1.96	0.30	1.72	0.30																																	
		CK	J	K	+Q	-Q																																																																				
↗	0	0	0	1																																																																						
↗	1	1	1	0																																																																						
↗	0	1	+Q0	-Q0																																																																						
↗	1	0	-Q0	+Q0																																																																						
↘	X	X	+Q0	-Q0																																																																						
-Q	1.96	0.30	1.72	0.30																																																																						
JK flip-flop with CLR TFJC1	<table border="1"> <tr><th>CK</th><th>J</th><th>K</th><th>CL</th><th>+Q</th><th>-Q</th></tr> <tr><td>↗</td><td>0</td><td>0</td><td>0</td><td>0</td><td>1</td></tr> <tr><td>↗</td><td>1</td><td>1</td><td>0</td><td>1</td><td>0</td></tr> <tr><td>↗</td><td>0</td><td>1</td><td>0</td><td>+Q0</td><td>-Q0</td></tr> <tr><td>↗</td><td>1</td><td>0</td><td>0</td><td>-Q0</td><td>+Q0</td></tr> <tr><td>↘</td><td>X</td><td>X</td><td>0</td><td>+Q0</td><td>-Q0</td></tr> <tr><td>X</td><td>X</td><td>X</td><td>1</td><td>0</td><td>1</td></tr> </table> 	CK	J	K	CL	+Q	-Q	↗	0	0	0	0	1	↗	1	1	0	1	0	↗	0	1	0	+Q0	-Q0	↗	1	0	0	-Q0	+Q0	↘	X	X	0	+Q0	-Q0	X	X	X	1	0	1	14	2 1 1 1	@ @ # #	C	CK	+Q	2.16	0.30	1.92	0.30																					
		CK	J	K	CL	+Q	-Q																																																																			
↗	0	0	0	0	1																																																																					
↗	1	1	0	1	0																																																																					
↗	0	1	0	+Q0	-Q0																																																																					
↗	1	0	0	-Q0	+Q0																																																																					
↘	X	X	0	+Q0	-Q0																																																																					
X	X	X	1	0	1																																																																					
CL	—	—	1.72	—	—																																																																					
						CK	-Q	2.00	0.30	1.94	0.30																																																															
							CL	2.08	—	—	—																																																															
JK flip-flop with PRE/CLR TFJPC1	<table border="1"> <tr><th>CK</th><th>J</th><th>K</th><th>PR</th><th>CL</th><th>+Q</th><th>-Q</th></tr> <tr><td>↗</td><td>0</td><td>0</td><td>1</td><td>0</td><td>0</td><td>1</td></tr> <tr><td>↗</td><td>1</td><td>1</td><td>1</td><td>0</td><td>1</td><td>0</td></tr> <tr><td>↗</td><td>0</td><td>1</td><td>1</td><td>0</td><td>+Q0</td><td>-Q0</td></tr> <tr><td>↗</td><td>1</td><td>0</td><td>1</td><td>0</td><td>-Q0</td><td>+Q0</td></tr> <tr><td>↘</td><td>X</td><td>X</td><td>1</td><td>0</td><td>+Q0</td><td>-Q0</td></tr> <tr><td>X</td><td>X</td><td>X</td><td>0</td><td>0</td><td>1</td><td>0</td></tr> <tr><td>X</td><td>X</td><td>X</td><td>1</td><td>1</td><td>0</td><td>1</td></tr> <tr><td>X</td><td>X</td><td>X</td><td>0</td><td>1</td><td>1</td><td>1</td></tr> </table> 	CK	J	K	PR	CL	+Q	-Q	↗	0	0	1	0	0	1	↗	1	1	1	0	1	0	↗	0	1	1	0	+Q0	-Q0	↗	1	0	1	0	-Q0	+Q0	↘	X	X	1	0	+Q0	-Q0	X	X	X	0	0	1	0	X	X	X	1	1	0	1	X	X	X	0	1	1	1	15	2 1 1 2 1	@ @ # @ #	C	CK	+Q	1.94	0.30	2.10	0.30
		CK	J	K	PR	CL	+Q	-Q																																																																		
↗	0	0	1	0	0	1																																																																				
↗	1	1	1	0	1	0																																																																				
↗	0	1	1	0	+Q0	-Q0																																																																				
↗	1	0	1	0	-Q0	+Q0																																																																				
↘	X	X	1	0	+Q0	-Q0																																																																				
X	X	X	0	0	1	0																																																																				
X	X	X	1	1	0	1																																																																				
X	X	X	0	1	1	1																																																																				
PR	1.32	—	1.30	—																																																																						
						CK	-Q	2.01	0.30	2.16	0.30																																																															
							PR	—	—	2.06	—																																																															
						CL	—	1.72	—	1.34	—																																																															

HG62G Series

Flip-Flops (with Scan Function) (cont)

Function and Macro Name	Macro		LV	Clamp Level when Open	Sym- bol No.	Delay																																			
	Equiv. Circuit and Symbol	Equiv. Gate Count				In- put Name	Out- put Name	t_{plh} (ns)		t_{phi} (ns)																															
								t_{olh}	K_{lh}	t_{ohl}	K_{hl}																														
T flip-flop with CLR TFTC1	<table border="1"> <tr><th>CK</th><th>CL</th><th>+Q</th><th>-Q</th></tr> <tr><td></td><td>0</td><td>-Q0</td><td>+Q0</td></tr> <tr><td></td><td>0</td><td>+Q0</td><td>-Q0</td></tr> <tr><td>X</td><td>1</td><td>0</td><td>1</td></tr> </table>	CK	CL	+Q	-Q		0	-Q0	+Q0		0	+Q0	-Q0	X	1	0	1	10	1	@	C	CK	+Q	1.34	0.30	1.30	0.30														
		CK	CL	+Q	-Q																																				
			0	-Q0	+Q0																																				
			0	+Q0	-Q0																																				
X	1	0	1																																						
2	#		CL		—	—	0.87																																		
			CK	-Q	1.10	0.30	1.19	0.30																																	
			CL		0.67		—																																		
T flip-flop with PRE TFTP1	<table border="1"> <tr><th>CK</th><th>PR</th><th>+Q</th><th>-Q</th></tr> <tr><td></td><td>0</td><td>-Q0</td><td>+Q0</td></tr> <tr><td></td><td>0</td><td>+Q0</td><td>-Q0</td></tr> <tr><td>X</td><td>1</td><td>1</td><td>0</td></tr> </table>	CK	PR	+Q	-Q		0	-Q0	+Q0		0	+Q0	-Q0	X	1	1	0	10	1	@	C	CK	+Q	1.26	0.30	1.35	0.30														
		CK	PR	+Q	-Q																																				
			0	-Q0	+Q0																																				
			0	+Q0	-Q0																																				
X	1	1	0																																						
2	#		PR		1.02	—	—																																		
			CK	-Q	1.15	0.30	1.11	0.30																																	
			PR		—		0.87																																		
T flip-flop with PRE/CLR TFTPC3	<table border="1"> <tr><th>CK</th><th>PR</th><th>CL</th><th>+Q</th><th>-Q</th></tr> <tr><td></td><td>0</td><td>0</td><td>-Q0</td><td>+Q0</td></tr> <tr><td></td><td>0</td><td>0</td><td>+Q0</td><td>-Q0</td></tr> <tr><td>X</td><td>1</td><td>0</td><td>1</td><td>0</td></tr> <tr><td>X</td><td>0</td><td>1</td><td>0</td><td>1</td></tr> <tr><td>X</td><td>1</td><td>1</td><td>0</td><td>1</td></tr> </table>	CK	PR	CL	+Q	-Q		0	0	-Q0	+Q0		0	0	+Q0	-Q0	X	1	0	1	0	X	0	1	0	1	X	1	1	0	1	11	1	@	C	CK	+Q	1.36	0.30	1.45	0.30
		CK	PR	CL	+Q	-Q																																			
			0	0	-Q0	+Q0																																			
			0	0	+Q0	-Q0																																			
		X	1	0	1	0																																			
		X	0	1	0	1																																			
X	1	1	0	1																																					
2	#		PR		1.26	—	—																																		
2	#		CL		1.04		0.97																																		
			CK	-Q	1.25	0.30	1.21	0.30																																	
			PR		—		1.11																																		
			CL		0.77		0.89																																		
4-bit D flip-flop TFD4	<table border="1"> <tr><th>CK</th><th>+Q0</th><th>+Q1</th><th>+Q2</th><th>+Q3</th></tr> <tr><td></td><td>D0</td><td>D1</td><td>D2</td><td>D3</td></tr> <tr><td></td><td>+Q00</td><td>+Q10</td><td>+Q20</td><td>+Q30</td></tr> </table>	CK	+Q0	+Q1	+Q2	+Q3		D0	D1	D2	D3		+Q00	+Q10	+Q20	+Q30	29	1	@	B4	CK	+Q0-	1.40	0.30	1.85	0.30															
		CK	+Q0	+Q1	+Q2	+Q3																																			
			D0	D1	D2	D3																																			
			+Q00	+Q10	+Q20	+Q30																																			
1	@				+Q3																																				
1	@																																								
1	@																																								

Flip-Flops (with Scan Function) (cont)

Macro		Equiv. Gate Count	LV	Clamp Level when Open	Sym - bol No.	Delay																													
Function and Macro Name	Equiv. Circuit and Symbol					In - put Name	Out - put Name	t _{plh} (ns)		t _{phl} (ns)																									
								t _{oH}	K _H	t _{oL}	K _L																								
4-bit D flip-flop with CLR TFD4C1	<table border="1"> <tr> <th>CK</th> <th>CL</th> <th>+Q0</th> <th>+Q1</th> <th>+Q2</th> <th>+Q3</th> </tr> <tr> <td></td> <td>0</td> <td>D0</td> <td>D1</td> <td>D2</td> <td>D3</td> </tr> <tr> <td></td> <td>0</td> <td>+Q0</td> <td>+Q1</td> <td>+Q2</td> <td>+Q3</td> </tr> <tr> <td>X</td> <td>1</td> <td>0</td> <td>0</td> <td>0</td> <td>0</td> </tr> </table>	CK	CL	+Q0	+Q1	+Q2	+Q3		0	D0	D1	D2	D3		0	+Q0	+Q1	+Q2	+Q3	X	1	0	0	0	0	34	1	@	B4	CK	+Q0-	1.60	0.30	1.85	0.30
	CK	CL	+Q0	+Q1	+Q2	+Q3																													
		0	D0	D1	D2	D3																													
		0	+Q0	+Q1	+Q2	+Q3																													
	X	1	0	0	0	0																													
			1	#																															

Shift Registers (with Scan Function)

Macro		Equiv. Gate Count	LV	Clamp Level when Open	Sym - bol No.	Delay																														
Function and Macro Name	Equiv. Circuit and Symbol					In - put Name	Out - put Name	t _{plh} (ns)		t _{phl} (ns)																										
								t _{oH}	K _H	t _{oL}	K _L																									
2-bit shift register TZSR	<table border="1"> <tr> <th>CK</th> <th>+A</th> <th>+B</th> </tr> <tr> <td></td> <td>D</td> <td>+A0</td> </tr> <tr> <td></td> <td>+A0</td> <td>+B0</td> </tr> </table>	CK	+A	+B		D	+A0		+A0	+B0	13	1	@	B	CK	+A	1.16	0.30	1.33	0.30																
	CK	+A	+B																																	
	D	+A0																																		
	+A0	+B0																																		
2-bit shift register with CLR TZSRC1	<table border="1"> <tr> <th>CK</th> <th>CLA</th> <th>CLB</th> <th>+A</th> <th>+B</th> </tr> <tr> <td></td> <td>0</td> <td>0</td> <td>D</td> <td>+A0</td> </tr> <tr> <td></td> <td>0</td> <td>0</td> <td>+A0</td> <td>+B0</td> </tr> <tr> <td>X</td> <td>1</td> <td>X</td> <td>0</td> <td>X</td> </tr> <tr> <td>X</td> <td>X</td> <td>1</td> <td>X</td> <td>0</td> </tr> </table>	CK	CLA	CLB	+A	+B		0	0	D	+A0		0	0	+A0	+B0	X	1	X	0	X	X	X	1	X	0	16	1	@	C	CK	+A	1.26	0.30	1.43	0.30
	CK	CLA	CLB	+A	+B																															
		0	0	D	+A0																															
		0	0	+A0	+B0																															
	X	1	X	0	X																															
X	X	1	X	0																																
			2	#																																

HG62G Series

Shift Registers (with Scan Function) (cont)

Function and Macro Name	Macro							Equiv. Gate Count	LV	Clamp Level when Open	Sym- bol No.	Delay								
	Equiv. Circuit and Symbol											In- put Name	Out- put Name	t _{plh} (ns)		t _{phl} (ns)				
	CK	CLA	CLB	PRA	PRB	+A	+B							t _{oH}	K _{th}	t _{oL}	K _{hl}			
2-bit shift register with CLR/PRE TZSRCP3	0	0	0	0	0	D	+A0	18	1	@	B4	CK	+A	1.46	0.30	1.63	0.30			
	↗	0	0	0	0	D	+A0					CLA		0.75		1.55				
	↘	0	0	0	0	+A0	+B0					PRA		0.82		—				
	X	1	X	X	X	0	X					CK	+B	1.46	0.30	1.63	0.30			
	X	X	1	X	X	X	0					CLB		0.75		1.55				
	X	X	X	1	X	1	X					PRB		0.82		—				
	X	X	X	X	1	X	1													
	X	1	X	1	X	0	X													
	X	X	1	X	1	X	0													
4-bit shift register TZSR4	CK	+A	+B	+C	+D	29	1	@	C	CK	+A	1.38	0.30	1.55	0.30					
	↗	D	+A0	+B0	+C0							+B	1.38	0.30	1.55	0.30				
	↘	+A0	+B0	+C0	+D0							+C	1.38	0.30	1.55	0.30				
	TZSR4				+D							1.38	0.30	1.55	0.30					
4-bit shift register with CLR TZSR4C1	CK	CLA	CLB	CLC	CLD	+A	+B	+C	+D	37	1	@	B4	CK	+A	1.58	0.30	1.75	0.30	
	↗	0	0	0	0	D	+A0	+B0	+C0					CLA		—		1.35		
	↘	0	0	0	0	+A0	+B0	+C0	+D0					CK	+B	1.58	0.30	1.75	0.30	
	X	1	X	X	X	0	X	X	X					CLB		—		1.35		
	X	X	1	X	X	X	0	X	X					CK	+C	1.58	0.30	1.75	0.30	
	X	X	X	1	X	X	X	0	X					CLC		—		1.35		
	X	X	X	X	1	X	X	X	0					CK	+D	1.58	0.30	1.75	0.30	
	TZSR4C1													CLD		—		1.35		

Power Latches

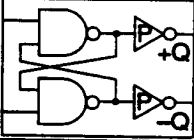
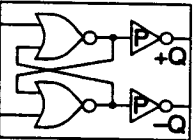
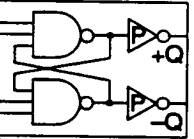
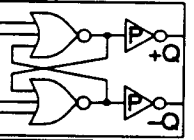
Macro				Delay																											
Function and Macro Name	Equiv. Circuit and Symbol	Equiv. Gate Count	LV	Clamp Level when Open	Symbol No.	In-put Name	Out-put Name	t_{ph} (ns)		t_{pl} (ns)																					
								t_{oh}	K_{th}	t_{oh}	K_{pl}																				
RS latch LRS0H	<table border="1"> <tr><th>SN</th><th>RN</th><th>+Q</th><th>-Q</th></tr> <tr><td>0</td><td>0</td><td>0</td><td>0</td></tr> <tr><td>0</td><td>1</td><td>1</td><td>0</td></tr> <tr><td>1</td><td>0</td><td>0</td><td>1</td></tr> <tr><td>1</td><td>1</td><td colspan="2">Latch</td></tr> </table> 	SN	RN	+Q	-Q	0	0	0	0	0	1	1	0	1	0	0	1	1	1	Latch		4	1	@ @	A3	S	+Q	0.75	0.30	—	0.30
	SN	RN	+Q	-Q																											
	0	0	0	0																											
	0	1	1	0																											
	1	0	0	1																											
1	1	Latch																													
R		0.61		0.45																											
S	-Q	0.61	0.30	0.45	0.30																										
R		0.75		—																											
RS latch LRS3H	<table border="1"> <tr><th>S</th><th>R</th><th>+Q</th><th>-Q</th></tr> <tr><td>0</td><td>0</td><td colspan="2">Latch</td></tr> <tr><td>0</td><td>1</td><td>0</td><td>1</td></tr> <tr><td>1</td><td>0</td><td>1</td><td>0</td></tr> <tr><td>1</td><td>1</td><td>1</td><td>1</td></tr> </table> 	S	R	+Q	-Q	0	0	Latch		0	1	0	1	1	0	1	0	1	1	1	1	4	1	# #	A3	S	+Q	0.45	0.30	0.75	0.30
	S	R	+Q	-Q																											
	0	0	Latch																												
	0	1	0	1																											
	1	0	1	0																											
1	1	1	1																												
R		—		0.82																											
S	-Q	—	0.30	0.82	0.30																										
R		0.45		0.75																											
2-input RS latch LR2S20H	<table border="1"> <tr><th>SN</th><th>RN</th><th>+Q</th><th>-Q</th></tr> <tr><td>0</td><td>0</td><td>0</td><td>0</td></tr> <tr><td>0</td><td>1</td><td>1</td><td>0</td></tr> <tr><td>1</td><td>0</td><td>0</td><td>1</td></tr> <tr><td>1</td><td>1</td><td colspan="2">Latch</td></tr> </table> 	SN	RN	+Q	-Q	0	0	0	0	0	1	1	0	1	0	0	1	1	1	Latch		5	1	@ @ @ @	A4	S	+Q	0.82	0.30	—	0.30
	SN	RN	+Q	-Q																											
	0	0	0	0																											
	0	1	1	0																											
	1	0	0	1																											
1	1	Latch																													
R		0.75		0.50																											
S	-Q	0.75	0.30	0.50	0.30																										
R		0.82		—																											
2-input RS latch LR2S23H	<table border="1"> <tr><th>S</th><th>R</th><th>+Q</th><th>-Q</th></tr> <tr><td>0</td><td>0</td><td colspan="2">Latch</td></tr> <tr><td>0</td><td>1</td><td>0</td><td>1</td></tr> <tr><td>1</td><td>0</td><td>1</td><td>0</td></tr> <tr><td>1</td><td>1</td><td>1</td><td>1</td></tr> </table> 	S	R	+Q	-Q	0	0	Latch		0	1	0	1	1	0	1	0	1	1	1	1	5	1	# # #	A4	S	+Q	0.50	0.30	0.82	0.30
	S	R	+Q	-Q																											
	0	0	Latch																												
	0	1	0	1																											
	1	0	1	0																											
1	1	1	1																												
R		—		0.96																											
S	-Q	—	0.30	0.96	0.30																										
R		0.50		0.82																											

HG62G Series

Power Latches (cont)

Function and Macro Name	Macro Equiv. Circuit and Symbol	Equiv. Gate Count	LV	Clamp Level when Open	Sym - bol No.	Delay					
						In - put Name	Out - put Name	t_{plh} (ns)		t_{phi} (ns)	
								t_{o1h}	K_{th}	t_{o1l}	K_{hl}
D Latch LDH		5	2	@	C	G	+Q	0.80	0.30	0.80	0.30
						D		0.80		0.80	
						G	-Q	0.95	0.30	1.00	0.30
						D		0.95		1.00	
D Latch with CLR LDC1H		6	2	@	C	G	+Q	1.25	0.30	1.15	0.30
						D		1.25		1.15	
						CL		0.80		0.75	
						G	-Q	0.95	0.30	1.10	0.30
						D		0.95		1.10	
						CL		0.55		0.65	
D Latch with PRE LDP1H		6	2	@	C	G	+Q	0.80	0.30	0.90	0.30
						D		0.80		0.90	
						PR		0.55		0.65	
						G	-Q	1.05	0.30	1.00	0.30
						D		1.05		1.00	
						PR		0.80		0.75	
D Latch with CLR/PRE LDPC3H		7	2	@	C	G	+Q	1.35	0.30	1.35	0.30
						D		1.35		1.35	
						PR		1.05		0.90	
						CL		0.80		0.75	
						G	-Q	1.15	0.30	1.20	0.30
						D		1.15		1.20	
						PR		0.70		0.90	
						CL		0.55		0.65	

Power Latches (cont)

Function and Macro Name	Macro		LV	Clamp Level when Open	Sym- bol No.	Delay					
	Equiv. Circuit and Symbol	Equiv. Gate Count				In- put Name	Out- put Name	t _{plh} (ns)		t _{phi} (ns)	
								t _{oLh}	K _{Lh}	t _{oHl}	K _{Hl}
4-bit latch LD4H	G	+Q0 +Q1 +Q2 +Q3	14	@	B4	G	+Q0-	0.92	0.30	1.03	0.30
	1	D0 D1 D2 D3									
	Latch										
4-bit latch with CLR LD4C1H	G	CL +Q0 +Q1 +Q2 +Q3	15	@	B4	G	+Q0-	0.92	0.30	1.03	0.30
	1	0 D0 D1 D2 D3									
	Latch										
	X	1 0 0 0 0									
	X: Don't care										

Power Flip-Flops

Function and Macro Name	Macro		LV	Clamp Level when Open	Sym- bol No.	Delay					
	Equiv. Circuit and Symbol	Equiv. Gate Count				In- put Name	Out- put Name	t _{plh} (ns)		t _{phi} (ns)	
								t _{oLh}	K _{Lh}	t _{oHl}	K _{Hl}
D flip-flop FDH	CK	+Q -Q	7	@	C	CK	+Q	0.84	0.30	0.90	0.30
	D	D									
	+Q0 -Q0										
			1	@							
								1.05	0.30	1.04	0.30

HG62G Series

Power Flip-Flops (cont)

Function and Macro Name	Macro		Equiv. Gate Count	LV	Clamp Level when Open	Sym-bol No.	Delay																
	Equiv. Circuit and Symbol	In-put Name					Out-put Name	t_{ph} (ns)		t_{pl} (ns)													
								t_{oh}	K_{lh}	t_{oh}	K_{hl}												
D flip-flop with load FDL1H	CK	L	+Q	-Q	9	1	@	C	CK	+Q	0.84	0.30	0.90	0.30									
		0	DC	DC											2	@	#	-Q	1.05	0.30	1.04	0.30	
		1	DL	DL																			
		X	+Q0	-Q0																			
D flip-flop with CLR FDC1H	CK	CL	+Q	-Q	8	1	@	C	CK	+Q	0.84	0.30	0.90	0.30									
		0	D	\bar{D}											2	#	CK	-Q	1.05	0.30	1.14	0.30	
		0	+Q0	-Q0																			
	X	1	0	1																			
D flip-flop with PRE FDP1H	CK	PR	+Q	-Q	8	1	@	C	CK	+Q	0.86	0.30	0.94	0.30									
		0	D	\bar{D}											2	#	CK	-Q	1.10	0.30	1.06	0.30	
		0	+Q0	-Q0																			
	X	1	1	0																			
D flip-flop with CLR/PRE FDPC3H	CK	PR	CL	+Q	-Q	9	1	@	C	CK	+Q	0.86	0.30	0.94	0.30								
		0	0	D	\bar{D}											2	#	CK	-Q	1.10	0.30	1.06	0.30
		0	0	+Q0	-Q0																		
	X	1	0	1	0																		
	X	0	1	0	1																		
	X	1	1	1	1																		

Power Flip-Flops (cont)

Function and Macro Name	Macro						LV	Clamp Level when Open	Sym - bol No.	Delay									
	Equiv. Circuit and Symbol									Equiv. Gate Count	In - put Name	Out - put Name	t _{plh} (ns)		t _{phi} (ns)				
													t _{oH}	K _{th}	t _{oHl}	K _{Hl}			
JK flip-flop FJH	CK	J	K	+Q	-Q	10	2	@	C	CK	+Q	1.16	0.30	0.92	0.30				
		0	0	0	1		1	@											
		1	1	1	0		1	#											
		0	1	+Q0	-Q0														
		1	0	-Q0	+Q0														
		X	X	+Q0	-Q0														
JK flip-flop with CLR FJC1H	CK	J	K	CL	+Q	-Q	13	2	@	C	CK	+Q	1.36	0.30	1.12	0.30			
		0	0	0	0	1		1	@		CL						—	0.92	
		1	1	0	1	0		1	#		CK	-Q	1.20	0.30	1.14	0.30			
		0	1	0	+Q0	-Q0					CL						1.28	—	
		1	0	0	-Q0	+Q0													
		X	X	0	+Q0	-Q0													
		X	X	X	1	0		1											
JK flip-flop with PRE/CLR FJPC1H	CK	J	K	PR	CL	+Q	-Q	14	2	@	C	CK	+Q	1.36	0.30	1.21	0.30		
		0	0	1	0	0	1		1	@		PR						1.26	—
		1	1	1	0	1	0		1	#		CL						0.54	0.92
		0	1	1	0	+Q0	-Q0					CK	-Q	1.30	0.30	1.14	0.30		
		1	0	1	0	-Q0	+Q0					PR						0.50	0.52
		X	X	1	0	+Q0	-Q0					CL						1.30	—
		X	X	X	0	0	1		0										
		X	X	X	1	1	0		1										
		X	X	X	0	1	0		0										

HG62G Series

Power Flip-Flops (cont)

Function and Macro Name	Macro Equiv. Circuit and Symbol	Equiv. Gate Count	LV	Clamp Level when Open	Sym- bol No.	Delay																																			
						In- put Name	Out- put Name	t_{plh} (ns)		t_{phl} (ns)																															
								t_{0th}	K_{th}	t_{0hl}	K_{hl}																														
T flip-flop with CLR FTC1H	<table border="1"> <tr><th>CK</th><th>CL</th><th>+Q</th><th>-Q</th></tr> <tr><td></td><td>0</td><td>-Q0</td><td>+Q0</td></tr> <tr><td></td><td>0</td><td>+Q0</td><td>-Q0</td></tr> <tr><td>X</td><td>1</td><td>0</td><td>1</td></tr> </table>	CK	CL	+Q	-Q		0	-Q0	+Q0		0	+Q0	-Q0	X	1	0	1	9	1	@	C	CK	+Q	0.84	0.30	0.90	0.30														
		CK	CL	+Q	-Q																																				
			0	-Q0	+Q0																																				
			0	+Q0	-Q0																																				
X	1	0	1																																						
CL		—		1.06																																					
CK	-Q	1.05	0.30	1.14	0.30																																				
CL		0.62		—																																					
T flip-flop with PRE FTP1H	<table border="1"> <tr><th>CK</th><th>PR</th><th>+Q</th><th>-Q</th></tr> <tr><td></td><td>0</td><td>-Q0</td><td>+Q0</td></tr> <tr><td></td><td>0</td><td>+Q0</td><td>-Q0</td></tr> <tr><td>X</td><td>1</td><td>1</td><td>0</td></tr> </table>	CK	PR	+Q	-Q		0	-Q0	+Q0		0	+Q0	-Q0	X	1	1	0	9	1	@	C	CK	+Q	0.86	0.30	0.94	0.30														
		CK	PR	+Q	-Q																																				
			0	-Q0	+Q0																																				
			0	+Q0	-Q0																																				
X	1	1	0																																						
PR		0.62		—																																					
CK	-Q	1.10	0.30	1.06	0.30																																				
PR		—		0.82																																					
T flip-flop with PRE/CLR FTPC3H	<table border="1"> <tr><th>CK</th><th>PR</th><th>CL</th><th>+Q</th><th>-Q</th></tr> <tr><td></td><td>0</td><td>0</td><td>-Q0</td><td>+Q0</td></tr> <tr><td></td><td>0</td><td>0</td><td>+Q0</td><td>-Q0</td></tr> <tr><td>X</td><td>1</td><td>0</td><td>1</td><td>0</td></tr> <tr><td>X</td><td>0</td><td>1</td><td>0</td><td>1</td></tr> <tr><td>X</td><td>1</td><td>1</td><td>1</td><td>1</td></tr> </table>	CK	PR	CL	+Q	-Q		0	0	-Q0	+Q0		0	0	+Q0	-Q0	X	1	0	1	0	X	0	1	0	1	X	1	1	1	1	10	1	@	C	CK	+Q	0.86	0.30	0.94	0.30
		CK	PR	CL	+Q	-Q																																			
			0	0	-Q0	+Q0																																			
			0	0	+Q0	-Q0																																			
		X	1	0	1	0																																			
		X	0	1	0	1																																			
X	1	1	1	1																																					
PR		0.62		0.70																																					
CL		—		0.96																																					
CK	-Q	1.20	0.30	1.16	0.30																																				
PR		—		0.92																																					
CL		0.72		0.84																																					
4-bit D flip-flop FD4H	<table border="1"> <tr><th>CK</th><th>+Q0</th><th>+Q1</th><th>+Q2</th><th>+Q3</th></tr> <tr><td></td><td>D0</td><td>D1</td><td>D2</td><td>D3</td></tr> <tr><td></td><td>+Q00</td><td>+Q10</td><td>+Q20</td><td>+Q30</td></tr> </table>	CK	+Q0	+Q1	+Q2	+Q3		D0	D1	D2	D3		+Q00	+Q10	+Q20	+Q30	22	1	@	B4	CK	+Q0- +Q3	1.20	0.30	1.60	0.30															
		CK	+Q0	+Q1	+Q2	+Q3																																			
			D0	D1	D2	D3																																			
			+Q00	+Q10	+Q20	+Q30																																			

Power Flip-Flops (cont)

Function and Macro Name	Macro					Equiv. Gate Count	LV	Clamp Level when Open	Sym- bol No.	Delay						
	Equiv. Circuit and Symbol									In- put Name	Out- put Name	t _{plh} (ns)		t _{phi} (ns)		
												t _{olh}	K _{lh}	t _{ohl}	K _{hl}	
4-bit D flip-flop with CLR FD4C1H	CK	CL	+Q0	+Q1	+Q2	+Q3	26	1	@	B4	CK	+Q0-	1.40	0.30	1.60	0.30
		0	D0	D1	D2	D3		1	@				—	—	1.35	—
		0	+Q00	+Q10	+Q20	+Q30		1	@				—	—	—	—
	X	1	0	0	0	0		1	@				—	—	—	—
						1		#	—				—	—	—	

Power Shift Registers

Function and Macro Name	Macro					Equiv. Gate Count	LV	Clamp Level when Open	Sym- bol No.	Delay					
	Equiv. Circuit and Symbol									In- put Name	Out- put Name	t _{plh} (ns)		t _{phi} (ns)	
												t _{olh}	K _{lh}	t _{ohl}	K _{hl}
2-bit shift register ZSRH	CK	+A	+B			11	1	@	B1	CK	+A	0.96	0.30	1.08	0.30
		D	+A0				1	@				+B	0.96	0.30	1.08
2-bit shift register with CLR ZSRC1H	CK	CLA	CLB	+A	+B	13	1	@	C	CK	+A	1.06	0.30	1.18	0.30
		0	0	D	+A0		1	#				—	—	1.10	—
		0	0	+A0	+B0		2	#				—	—	—	—
	X	1	X	0	X		2	#				—	—	—	—
	X	X	1	X	0		2	#				—	—	—	—

HG62G Series

Power Shift Registers (cont)

Function and Macro Name	Macro							Equiv. Gate Count	LV	Clamp Level when Open	Sym- bol No.	Delay							
	Equiv. Circuit and Symbol											In- put Name	Out- put Name	t _{plh} (ns)		t _{phl} (ns)			
	CK	CLA	CLB	PRA	PRB	+A	+B							t _{oH}	K _H	t _{oL}	K _L		
2-bit shift register with CLR/PRE ZSRCP3H	CK	CLA	CLB	PRA	PRB	+A	+B	15	1	@	B4	CK	+A	1.26	0.30	1.38	0.30		
	0	0	0	0	0	D	+A0					—	—	—	1.30	—			
	0	0	0	0	0	+A0	+B0					0.62	—	0.70	—	—			
	X	1	X	X	X	0	X					CK	+B	1.26	0.30	1.38	0.30		
	X	X	1	X	X	X	0					CLB	—	—	1.30	—			
	X	X	X	1	X	1	X					PRB	0.62	—	0.70	—			
	X	X	X	X	1	X	1					—	—	—	—	—			
	X	1	X	1	X	1	X					—	—	—	—	—			
	X	X	1	X	1	X	1					—	—	—	—	—			
												—	—	—	—	—	—		
4-bit shift register ZSR4H	CK	+A	+B	+C	+D			20	1	@	C	CK	+A	1.18	0.30	1.30	0.30		
	0	D	+A0	+B0	+C0	+D	+A					1.18	0.30	1.30	0.30				
	0	+A0	+B0	+C0	+D0	+B	1.18					0.30	1.30	0.30					
												+C	1.18	0.30	1.30	0.30			
												+D	1.18	0.30	1.30	0.30			
4-bit shift register with CLR ZSR4C1H	CK	CLA	CLB	CLC	CLD	+A	+B	+C	+D	24	1	@	B4	CK	+A	1.38	0.30	1.50	0.30
	0	0	0	0	0	D	+A0	+B0	+C0					—	—	1.10	—		
	0	0	0	0	0	+A0	+B0	+C0	+D0					0.62	—	0.70	—		
	X	1	X	X	X	0	X	X	X					CK	+B	1.38	0.30	1.50	0.30
	X	X	1	X	X	X	0	X	X					CLB	—	—	1.10	—	
	X	X	X	1	X	X	0	X	X					CK	+C	1.38	0.30	1.50	0.30
	X	X	X	X	1	X	X	0	X					CLC	—	—	1.10	—	
	X	X	X	X	1	X	X	0	X					CK	+D	1.38	0.30	1.50	0.30
								CLD	—					—	1.10	—			
								—	—					—	—	—			

Latches (Normal)

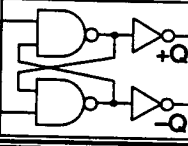
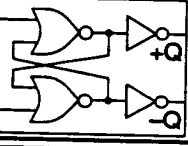
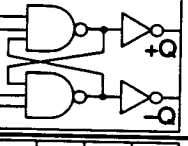
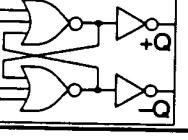
Function and Macro Name	Macro		LV	Clamp Level when Open	Sym- bol No.	Delay																									
	Equiv. Circuit and Symbol	Equiv. Gate Count				In- put Name	Out- put Name	t_{ph} (ns)		t_{pl} (ns)																					
								t_{oh}	K_{th}	t_{ohl}	K_{hl}																				
RS latch LRS0	<table border="1"> <tr><th>SN</th><th>RN</th><th>+Q</th><th>-Q</th></tr> <tr><td>0</td><td>0</td><td>0</td><td>0</td></tr> <tr><td>0</td><td>1</td><td>1</td><td>0</td></tr> <tr><td>1</td><td>0</td><td>0</td><td>1</td></tr> <tr><td>1</td><td>1</td><td colspan="2">Latch</td></tr> </table> 	SN	RN	+Q	-Q	0	0	0	0	0	1	1	0	1	0	0	1	1	1	Latch		3	1	@ @	A3	S	+Q	0.65	0.50	—	0.50
		SN	RN	+Q	-Q																										
		0	0	0	0																										
		0	1	1	0																										
		1	0	0	1																										
1	1	Latch																													
R		0.51		0.35																											
S	-Q	0.51	0.50	0.35	0.50																										
R		0.65		—																											
RS latch LRS3	<table border="1"> <tr><th>S</th><th>R</th><th>+Q</th><th>-Q</th></tr> <tr><td>0</td><td>0</td><td colspan="2">Latch</td></tr> <tr><td>0</td><td>1</td><td>0</td><td>1</td></tr> <tr><td>1</td><td>0</td><td>1</td><td>0</td></tr> <tr><td>1</td><td>1</td><td>1</td><td>1</td></tr> </table> 	S	R	+Q	-Q	0	0	Latch		0	1	0	1	1	0	1	0	1	1	1	1	3	1	# #	A3	S	+Q	0.35	0.50	0.65	0.50
		S	R	+Q	-Q																										
		0	0	Latch																											
		0	1	0	1																										
		1	0	1	0																										
1	1	1	1																												
R		—		0.72																											
S	-Q	—	0.50	0.72	0.50																										
R		0.35		0.65																											
2-input RS latch LR2S20	<table border="1"> <tr><th>SN</th><th>RN</th><th>+Q</th><th>-Q</th></tr> <tr><td>0</td><td>0</td><td>0</td><td>0</td></tr> <tr><td>0</td><td>1</td><td>1</td><td>0</td></tr> <tr><td>1</td><td>0</td><td>0</td><td>1</td></tr> <tr><td>1</td><td>1</td><td colspan="2">Latch</td></tr> </table> 	SN	RN	+Q	-Q	0	0	0	0	0	1	1	0	1	0	0	1	1	1	Latch		4	1	@ @ @ @	A4	S	+Q	0.72	0.50	—	0.50
		SN	RN	+Q	-Q																										
		0	0	0	0																										
		0	1	1	0																										
		1	0	0	1																										
1	1	Latch																													
R		0.65		0.40																											
S	-Q	0.65	0.50	0.40	0.50																										
R		0.72		—																											
2-input RS latch LR2S23	<table border="1"> <tr><th>S</th><th>R</th><th>+Q</th><th>-Q</th></tr> <tr><td>0</td><td>0</td><td colspan="2">Latch</td></tr> <tr><td>0</td><td>1</td><td>0</td><td>1</td></tr> <tr><td>1</td><td>0</td><td>1</td><td>0</td></tr> <tr><td>1</td><td>1</td><td>1</td><td>1</td></tr> </table> 	S	R	+Q	-Q	0	0	Latch		0	1	0	1	1	0	1	0	1	1	1	1	4	1	# # # #	A4	S	+Q	0.40	0.50	0.72	0.50
		S	R	+Q	-Q																										
		0	0	Latch																											
		0	1	0	1																										
		1	0	1	0																										
1	1	1	1																												
R		—		0.86																											
S	-Q	—	0.50	0.86	0.50																										
R		0.40		0.72																											

HG62G Series

Latches (Normal) (cont)

Function and Macro Name	Macro Equiv. Circuit and Symbol	Equiv. Gate Count	LV	Clamp Level when Open	Sym- bol No.	Delay					
						In- put Name	Out- put Name	t_{ph} (ns)		t_{pl} (ns)	
								t_{oLh}	K_{th}	t_{oHl}	K_{pl}
D Latch LD		4	2 1	@ @	C	G	+Q	0.70	0.50	0.70	0.50
						D		0.70		0.70	
						G	-Q	0.85	0.50	0.90	0.50
						D		0.85		0.90	
D Latch with CLR LDC1	<p>X: Don't care</p>	5	2 1 1	@ @ #	C	G	+Q	1.15	0.50	1.05	0.50
						D		1.15		1.05	
						CL		0.70		0.65	
						G	-Q	0.85	0.50	1.00	0.50
						D		0.85		1.00	
						CL		0.45		0.55	
						G	+Q	0.70	0.50	0.80	0.50
						D		0.70		0.80	
D Latch with PRE LDP1	<p>X: Don't care</p>	5	2 1 1	@ @ #	C	G	+Q	0.70	0.50	0.80	0.50
						D		0.70		0.80	
						PR		0.45		0.55	
						G	-Q	0.95	0.50	0.90	0.50
						D		0.95		0.90	
						PR		0.70		0.65	
						G	+Q	1.25	0.50	1.25	0.50
						D		1.25		1.25	
D Latch with CLR/PRE LDPC3	<p>X: Don't care</p>	6	2 1 1 1	@ @ # #	C	G	+Q	1.25	0.50	1.25	0.50
						D		1.25		1.25	
						PR		0.95		0.80	
						CL		0.70		0.65	
						G	-Q	1.05	0.50	1.10	0.50
						D		1.05		1.10	
						PR		0.60		0.80	
						CL		0.45		0.55	

Latches (Normal) (cont)

Function and Macro Name	Macro		LV	Clamp Level when Open	Sym- bol No.	Delay						
	Equiv. Circuit and Symbol	Equiv. Gate Count				In- put Name	Out- put Name	t _{plh} (ns)		t _{phi} (ns)		
								t _{oth}	K _{th}	t _{ohl}	K _{hl}	
4-bit latch LD4	G	+Q0 +Q1 +Q2 +Q3	13	1	@	B4	G	+Q0- +Q3	0.82	0.50	0.93	0.50
	1	D0 D1 D2 D3										
		Latch										
4-bit latch with CLR LD4C1	G	CL +Q0 +Q1 +Q2 +Q3	14	1	@	B4	G	+Q0- +Q3	0.82	0.50	0.93	0.50
	1	0 D0 D1 D2 D3										
		0 Latch										
	X	1 0 0 0 0										
	X: Don't care											

Flip-Flops (Normal)

Function and Macro Name	Macro		LV	Clamp Level when Open	Sym- bol No.	Delay						
	Equiv. Circuit and Symbol	Equiv. Gate Count				In- put Name	Out- put Name	t _{plh} (ns)		t _{phi} (ns)		
								t _{oth}	K _{th}	t _{ohl}	K _{hl}	
D flip-flop FD	CK	+Q -Q	6	1	@	C	CK	+Q	0.74	0.50	0.80	0.50
		D D										
		+Q0 -Q0										

HG62G Series

Flip-Flops (Normal) (cont)

Function and Macro Name	Macro		Equiv. Gate Count	LV	Clamp Level when Open	Sym- bol No.	Delay																																		
	Equiv. Circuit and Symbol	In- put Name					Out- put Name	t_{plh} (ns)		t_{phl} (ns)																															
								t_{oth}	K_{th}	t_{ohl}	K_{hl}																														
D flip-flop with load FDL1	<table border="1"> <tr><td>CK</td><td>L</td><td>+Q</td><td>-Q</td></tr> <tr><td></td><td>0</td><td>DC</td><td>DC</td></tr> <tr><td></td><td>1</td><td>DL</td><td>DL</td></tr> <tr><td></td><td>X</td><td>+Q0</td><td>-Q0</td></tr> </table> 	CK	L	+Q	-Q		0	DC	DC		1	DL	DL		X	+Q0	-Q0	8	1	@	C	CK	+Q	0.74	0.50	0.80	0.50														
		CK	L	+Q	-Q																																				
			0	DC	DC																																				
			1	DL	DL																																				
	X	+Q0	-Q0																																						
-Q	0.95	0.50	0.94	0.50																																					
D flip-flop with CLR FDC1	<table border="1"> <tr><td>CK</td><td>CL</td><td>+Q</td><td>-Q</td></tr> <tr><td></td><td>0</td><td>D</td><td>D</td></tr> <tr><td></td><td>0</td><td>+Q0</td><td>-Q0</td></tr> <tr><td>X</td><td>1</td><td>0</td><td>1</td></tr> </table> 	CK	CL	+Q	-Q		0	D	D		0	+Q0	-Q0	X	1	0	1	7	1	@	C	CK	+Q	0.74	0.50	0.80	0.50														
		CK	CL	+Q	-Q																																				
			0	D	D																																				
			0	+Q0	-Q0																																				
X	1	0	1																																						
CL	—	—	0.96	—																																					
CK	-Q	0.95	0.50	1.04	0.50																																				
CL	—	0.52	—	—	—																																				
D flip-flop with PRE FDP1	<table border="1"> <tr><td>CK</td><td>PR</td><td>+Q</td><td>-Q</td></tr> <tr><td></td><td>0</td><td>D</td><td>D</td></tr> <tr><td></td><td>0</td><td>+Q0</td><td>-Q0</td></tr> <tr><td>X</td><td>1</td><td>1</td><td>0</td></tr> </table> 	CK	PR	+Q	-Q		0	D	D		0	+Q0	-Q0	X	1	1	0	7	1	@	C	CK	+Q	0.76	0.50	0.84	0.50														
		CK	PR	+Q	-Q																																				
			0	D	D																																				
			0	+Q0	-Q0																																				
X	1	1	0																																						
PR	0.52	—	—	—																																					
CK	-Q	1.00	0.50	0.96	0.50																																				
PR	—	—	—	0.72	—																																				
D flip-flop with PRE/CLR FDPC3	<table border="1"> <tr><td>CK</td><td>PR</td><td>CL</td><td>+Q</td><td>-Q</td></tr> <tr><td></td><td>0</td><td>0</td><td>D</td><td>D</td></tr> <tr><td></td><td>0</td><td>0</td><td>+Q0</td><td>-Q0</td></tr> <tr><td>X</td><td>1</td><td>0</td><td>1</td><td>0</td></tr> <tr><td>X</td><td>0</td><td>1</td><td>0</td><td>1</td></tr> <tr><td>X</td><td>1</td><td>1</td><td>1</td><td>1</td></tr> </table> 	CK	PR	CL	+Q	-Q		0	0	D	D		0	0	+Q0	-Q0	X	1	0	1	0	X	0	1	0	1	X	1	1	1	1	8	1	@	C	CK	+Q	0.76	0.50	0.84	0.50
		CK	PR	CL	+Q	-Q																																			
			0	0	D	D																																			
			0	0	+Q0	-Q0																																			
		X	1	0	1	0																																			
		X	0	1	0	1																																			
X	1	1	1	1																																					
CL	—	—	0.86	—																																					
PR	0.52	—	0.60	—																																					
CK	-Q	1.00	0.50	0.96	0.50																																				
CL	—	0.52	—	0.64	—																																				
PR	—	—	—	0.72	—																																				

Flip-Flops (Normal) (cont)

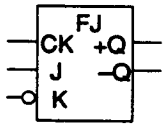
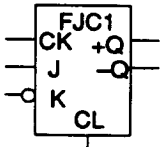
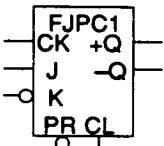
Function and Macro Name	Macro						Equiv. Gate Count	LV	Clamp Level when Open	Sym-bol No.	Delay					
	Equiv. Circuit and Symbol										In-put Name	Out-put Name	t _{plh} (ns)		t _{phl} (ns)	
	CK	J	K	+Q	-Q								t _{olh}	K _{th}	t _{ohl}	K _{hl}
JK flip-flop FJ	0	0	0	+Q	-Q	9	2 1 1	@ @ #	C	CK	+Q	1.06	0.50	0.82	0.50	
	1	1	1	0	-Q							1.06	0.50	0.82	0.50	
	0	1	+Q0	-Q0												
	1	0	-Q0	+Q0												
	X	X	+Q0	-Q0												
																
JK flip-flop with CLR FJC1	0	0	0	+Q	-Q	12	2 1 1 1	@ @ # #	C	CK	+Q	1.26	0.50	1.02	0.50	
	1	1	0	1	0					CL	—	—	0.82	—		
	0	1	0	+Q0	-Q0					CK	-Q	1.10	0.50	1.04	0.50	
	1	0	0	-Q0	+Q0					CL	—	1.18	—	—	—	
	X	X	0	+Q0	-Q0											
	X	X	X	1	0					1						
																
JK flip-flop with PRE/CLR FJPC1	0	0	1	0	+Q	-Q	13	@ @ # @ #	C	CK	+Q	1.26	0.50	1.11	0.50	
	1	1	1	0	1	0				PR	—	—	—			
	0	1	1	0	+Q0	-Q0				CL	0.44	—	0.82	—		
	1	0	1	0	-Q0	+Q0				CK	-Q	1.20	0.50	1.04	0.50	
	X	X	1	0	+Q0	-Q0				PR	—	0.40	—	0.42	—	
	X	X	X	0	0	1				0	CL	1.20	—	—	—	
	X	X	X	1	1	0				1						
	X	X	X	0	1	0				0						
																

HG62G Series

Flip-Flops (Normal) (cont)

Function and Macro Name	Macro		Equiv. Gate Count	LV	Clamp Level when Open	Sym- bol No.	Delay																																		
	Equiv. Circuit and Symbol	In- put Name					Out- put Name	t_{pth} (ns)		t_{phl} (ns)																															
								t_{olh}	K_{th}	t_{ohl}	K_{hl}																														
T flip-flop with CLR FTC1	<table border="1"> <tr><th>CK</th><th>CL</th><th>+Q</th><th>-Q</th></tr> <tr><td>↗</td><td>0</td><td>-Q0</td><td>+Q0</td></tr> <tr><td>↘</td><td>0</td><td>+Q0</td><td>-Q0</td></tr> <tr><td>X</td><td>1</td><td>0</td><td>1</td></tr> </table>	CK	CL	+Q	-Q	↗	0	-Q0	+Q0	↘	0	+Q0	-Q0	X	1	0	1	8	1	@	C	CK	+Q	0.74	0.50	0.80	0.50														
		CK	CL	+Q	-Q																																				
		↗	0	-Q0	+Q0																																				
		↘	0	+Q0	-Q0																																				
X	1	0	1																																						
CL		—		0.96																																					
CK	-Q	0.95	0.50	1.04	0.50																																				
CL		0.52		—																																					
T flip-flop with PRE FTP1	<table border="1"> <tr><th>CK</th><th>PR</th><th>+Q</th><th>-Q</th></tr> <tr><td>↗</td><td>0</td><td>-Q0</td><td>+Q0</td></tr> <tr><td>↘</td><td>0</td><td>+Q0</td><td>-Q0</td></tr> <tr><td>X</td><td>1</td><td>1</td><td>0</td></tr> </table>	CK	PR	+Q	-Q	↗	0	-Q0	+Q0	↘	0	+Q0	-Q0	X	1	1	0	8	1	@	C	CK	+Q	0.76	0.50	0.84	0.50														
		CK	PR	+Q	-Q																																				
		↗	0	-Q0	+Q0																																				
		↘	0	+Q0	-Q0																																				
X	1	1	0																																						
PR		0.52		—																																					
CK	-Q	1.00	0.50	0.96	0.50																																				
PR		—		0.72																																					
T flip-flop with PRE/CLR FTPC3	<table border="1"> <tr><th>CK</th><th>PR</th><th>CL</th><th>+Q</th><th>-Q</th></tr> <tr><td>↗</td><td>0</td><td>0</td><td>-Q0</td><td>+Q0</td></tr> <tr><td>↘</td><td>0</td><td>0</td><td>+Q0</td><td>-Q0</td></tr> <tr><td>X</td><td>1</td><td>0</td><td>1</td><td>0</td></tr> <tr><td>X</td><td>0</td><td>1</td><td>0</td><td>1</td></tr> <tr><td>X</td><td>1</td><td>1</td><td>1</td><td>1</td></tr> </table>	CK	PR	CL	+Q	-Q	↗	0	0	-Q0	+Q0	↘	0	0	+Q0	-Q0	X	1	0	1	0	X	0	1	0	1	X	1	1	1	1	9	1	@	C	CK	+Q	0.76	0.50	0.84	0.50
		CK	PR	CL	+Q	-Q																																			
		↗	0	0	-Q0	+Q0																																			
		↘	0	0	+Q0	-Q0																																			
		X	1	0	1	0																																			
		X	0	1	0	1																																			
X	1	1	1	1																																					
PR		0.52		0.60																																					
CL		—		0.86																																					
CK	-Q	1.10	0.50	1.06	0.50																																				
PR		—		0.82																																					
CL		0.62		0.74																																					
4-bit D flip-flop FD4	<table border="1"> <tr><th>CK</th><th>+Q0</th><th>+Q1</th><th>+Q2</th><th>+Q3</th></tr> <tr><td>↗</td><td>D0</td><td>D1</td><td>D2</td><td>D3</td></tr> <tr><td>↘</td><td>+Q00</td><td>+Q10</td><td>+Q20</td><td>+Q30</td></tr> </table>	CK	+Q0	+Q1	+Q2	+Q3	↗	D0	D1	D2	D3	↘	+Q00	+Q10	+Q20	+Q30	21	1	@	B4	CK	+Q0- +Q3	1.10	0.50	1.50	0.50															
		CK	+Q0	+Q1	+Q2	+Q3																																			
		↗	D0	D1	D2	D3																																			
		↘	+Q00	+Q10	+Q20	+Q30																																			

Flip-Flops (Normal) (cont)

Macro							Delay									
Function and Macro Name	Equiv. Circuit and Symbol						Equiv. Gate Count	LV	Clamp Level when Open	Sym-bol No.	In-put Name	Out-put Name	t _{plh} (ns)		t _{phl} (ns)	
													t _{olh}	K _{lh}	t _{ohl}	K _{hl}
4-bit D flip-flop with CLR FD4C1	CK	CL	+Q0	+Q1	+Q2	+Q3	25	1	@	B4	CK	+Q0-	1.30	0.50	1.50	0.50
		0	D0	D1	D2	D3					CL	+Q3	—	—	1.25	—
		0	+Q00	+Q10	+Q20	+Q30										
	X	1	0	0	0	0										

Shift Registers (Normal)

Macro							Delay									
Function and Macro Name	Equiv. Circuit and Symbol						Equiv. Gate Count	LV	Clamp Level when Open	Sym-bol No.	In-put Name	Out-put Name	t _{plh} (ns)		t _{phl} (ns)	
													t _{olh}	K _{lh}	t _{ohl}	K _{hl}
2-bit shift register ZSR	CK	+A	+B	10	1	@	B1	CK	+A	0.86	0.50	0.98	0.50			
		D	+A0						+B	0.86	0.50	0.98	0.50			
		+A0	+B0													
2-bit shift register with CLR ZSRC1	CK	CLA	CLB	+A	+B	12	1	@	C	CK	+A	0.96	0.50	1.08	0.50	
		0	0	D	+A0					CLA	—	—	1.00	—		
		0	0	+A0	+B0					CK	+B	0.96	0.50	1.08	0.50	
	X	1	X	0	X					CLB	—	—	1.00	—		
	X	X	1	X	0											

HG62G Series

Shift Registers (Normal)

Function and Macro Name	Macro							Equiv. Gate Count	LV	Clamp Level when Open	Sym- bol No.	Delay										
	Equiv. Circuit and Symbol											In- put Name	Out- put Name	t _{plh} (ns)		t _{phi} (ns)						
	CK	CLA	CLB	PRA	PRB	+A	+B							t _{olh}	K _{th}	t _{ohl}	K _{hl}					
2-bit shift register with CLR/PRE ZSRCP3	CK	CLA	CLB	PRA	PRB	+A	+B	14	1	@	B4	CK	+A	1.16	0.50	1.28	0.50					
	↗	0	0	0	0	D	+A0					1	@	CLA	—	—	—	1.20	—			
	↘	0	0	0	0	+A0	+B0					2	#	PRA	0.52	—	—	0.60	—			
	X	1	X	X	X	0	X					2	#	CK	+B	1.16	0.50	1.28	0.50	0.50		
	X	X	1	X	X	X	0					2	#	CLB	—	—	—	1.20	—			
	X	X	X	1	X	1	X					2	#	PRB	0.52	—	—	0.60	—			
	X	X	X	X	1	X	1															
	X	1	X	1	X	1	X															
	X	X	1	X	1	X	1															
4-bit shift register ZSR4	CK	+A	+B	+C	+D			19	1	@	C	CK	+A	1.08	0.50	1.20	0.50					
	↗	D	+A0	+B0	+C0								+B	1.08	0.50	1.20	0.50					
	↘	+A0	+B0	+C0	+D0								+C	1.08	0.50	1.20	0.50					
													+D	1.08	0.50	1.20	0.50					
4-bit shift register with CLR ZSR4C1	CK	CLA	CLB	CLC	CLD	+A	+B	+C	+D	23	1	@	B4	CK	+A	1.28	0.50	1.40	0.50			
	↗	0	0	0	0	D	+A0	+B0	+C0					1	@	CLA	—	—	—	1.00	—	
	↘	0	0	0	0	+A0	+B0	+C0	+D0					2	#	CK	+B	1.28	0.50	1.40	0.50	
	X	1	X	X	X	0	X	X	X					2	#	CLB	—	—	—	1.00	—	
	X	X	1	X	X	X	0	X	X					2	#	CK	+C	1.28	0.50	1.40	0.50	
	X	X	X	1	X	X	X	0	X							CLC	—	—	—	1.00	—	
	X	X	X	X	1	X	X	X	0							CK	+D	1.28	0.50	1.40	0.50	
																CLD	—	—	—	1.00	—	

Others (Power)

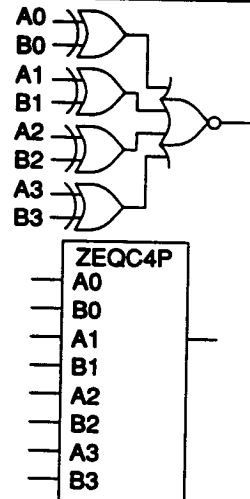
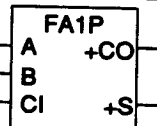
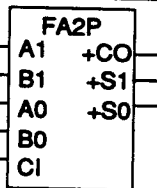
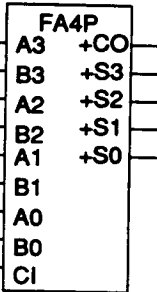
Function and Macro Name	Macro		LV	Clamp Level when Open	Sym- bol No.	In- put Name	Out- put Name	Delay			
	Equiv. Circuit and Symbol	Equiv. Gate Count						t _{plh} (ns)		t _{phl} (ns)	
								t _{oth}	K _{th}	t _{ohl}	K _{hl}
4-bit compar- ator ZEQC4P		14	2	# # # # # # #	B5	A0- A3, B0- B3		0.78	0.98	0.70	0.30
1-bit full adder FA1P		9	2 2 2	# # #	B2	A, B Ci	+CO	1.02 0.70	0.30	0.80 0.42	0.42
2-bit full adder FA2P		16	2 2 2 2	# # # #	C	An, Bn Ci	+CO	1.48 1.30	0.30	1.32 0.74	0.42
4-bit full adder FA4P		46	2 2 2 2 2 2 2 4	# # # # # # # #	B5	An, Bn Ci	+CO	1.30 1.10	0.30	1.22 1.06	0.30
						An, Bn Ci	+Sn	2.68 2.26	0.50	2.74 2.32	0.42

HG62G Series

Others (Power) (cont)

Function and Macro Name	Macro		LV	Clamp Level when Open	Sym- bol No.	In- put Name	Out- put Name	Delay			
	Equiv. Circuit and Symbol	Equiv. Gate Count						t _{plh} (ns)		t _{phi} (ns)	
								t _{olh}	K _{th}	t _{ohl}	K _{hl}
4-bit parity generator/checker PTGENP		42	1	#	B5	A-I	Ev	2.50	0.98	2.50	0.58
			1	#			OD	2.65	0.30	2.70	0.30
Power buffer BUFP		2	2	@	A1		+Y	0.51	0.30	0.44	0.30
						-Y	0.24	0.30	0.36	0.30	

Other (Normal)

Function and Macro Name	Macro		LV	Clamp Level when Open	Sym- bol No.	In- put Name	Out- put Name	Delay			
	Equiv. Circuit and Symbol	Equiv. Gate Count						t _{plh} (ns)		t _{phi} (ns)	
								t _{olh}	K _{th}	t _{ohl}	K _{hl}
4-bit comparator ZEQC4		12	2	#	B5	A0- A3, B0- B3		0.68	1.80	0.60	0.50

Other (Normal) (cont)

Function and Macro Name	Macro		Clamp Level when Open		Sym- bol No.	Delay						
	Equiv. Circuit and Symbol	Equiv. Gate Count				LV	In- put Name	Out- put Name	t _{plh} (ns)		t _{phl} (ns)	
									t _{onh}	K _{th}	t _{onl}	K _{hl}
1-bit full adder FA1		7	2 2 2	# # #	B2	A, B CI	+CO	0.92 0.60	0.50	0.70 0.32	0.76	
2-bit full adder FA2		14	2 2 2 2	# # # #	C	An, Bn CI	+CO	1.38 1.20	0.50	1.22 0.64	0.76	
4-bit full adder FA4		43	2 2 2 2 2 2 2 3	# # # # # # # #	B5	An, Bn CI	+CO	1.20 1.00	0.50	1.12 0.96	0.50	
9-bit parity generator/checker PTGEN		37	1 1 1 1 1 1 1 1	# # # # # # # #	B5	A-I	Ev OD	2.40 2.55	1.80 0.50	2.40 2.60	1.08 0.50	
Power buffer BUF		1	1	@	A1		+Y -Y	0.60 0.30	0.50 0.50	0.50 0.45	0.50 0.50	

HG62G Series

RAM

Macro		Delay							
Function and Macro Name	Equiv. Circuit and Symbol	LV	Clamp Level when Open	Input Name	Output Name	t_{pth} (ns)		t_{phi} (ns)	
						t_{olh}	K_{th}	t_{ohl}	K_{pl}
Single-port RAM		1	#	A0 to Ab-1	O0 to Ob-1	12	0.24	12	0.24
		1	#	R		6		6	
		1	#	W		—		—	
		1	@	G		12		12	
		1	#	I0 to Ib-1		—		—	
Cell Name	Function					Equivalent Gate Count			
TRAMS1A	256 W × 9 b (scan func.)					10000			
TRAMS2A	128 W × 18 b (scan func.)					10000			
TRAMS3A	64 W × 36 b (scan func.)					10000			
RAMS1A	256 W × 9 b					10000			
RAMS2A	128 W × 18 b					10000			
RAMS3A	64 W × 36 b					10000			
Dual-port RAM		1	#	A0 to Ab-1, B0 to Bb-1	OA0 to OAb-1, OB0 to OBb-1	12	0.24	12	0.24
		1	#	R, A, RB		6		6	
		1	#	W, A, WB		—		—	
		1	@	G, A, GB		12		12	
		1	#	IA0 to IAb-1, IB0 to IBb-1		—		—	
Cell Name	Function					Equivalent Gate Count			
TRAMD1A	128 W × 9 b (scan func.)					10000			
TRAMD2A	64 W × 18 b (scan func.)					10000			
TRAMD3A	32 W × 36 b (scan func.)					10000			
RAMD1A	128 W × 9 b					10000			
RAMD2A	64 W × 18 b					10000			
RAMD3A	32 W × 36 b					10000			

Single-Port RAM

Features

- One address, one R/W port
- Asynchronous
- Autodiagnosis
- 256 word × 9 bit
- 128 word × 18 bit
- 64 word × 36 bit

Notes

- Since the address latch (ADD-L, figure 2) is built in, G must be open (automatically pulled high) when it is not used.
- Outputs (O_0-O_{b-1}) are high impedance when read enable (R) is low.
- Change the address while write enable (W) is low only.

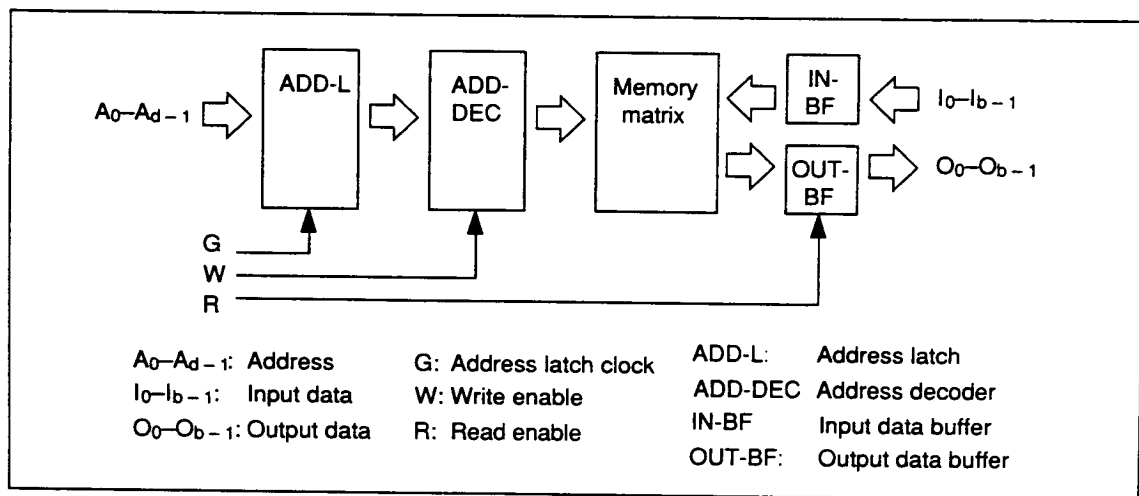

Figure 2 Single-Port RAM Block Diagram

HG62G Series

Timing

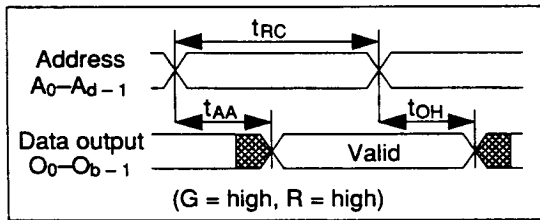

Figure 3 Single-Port Read Cycle Timing

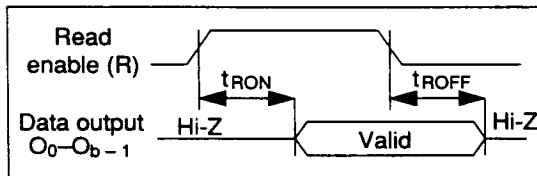

Figure 4 Single-Port Data Output Timing

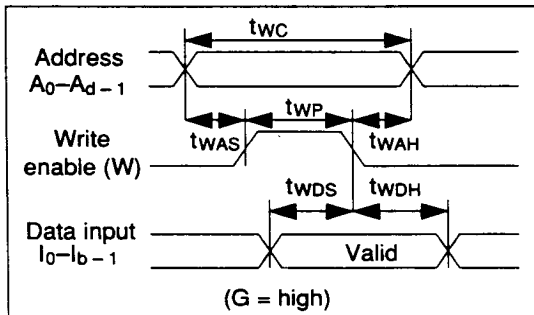

Figure 5 Single-Port Write Cycle Timing

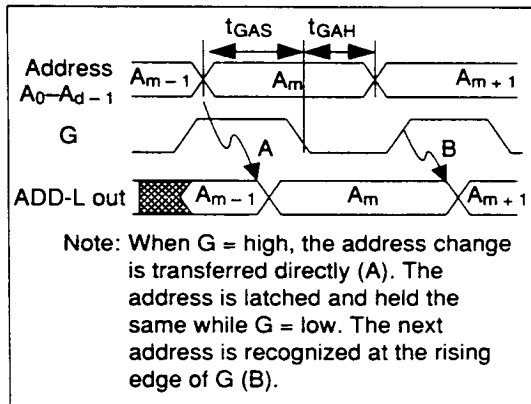

Figure 6 Single-Port Address Latch Timing

Table 6 Single-Port RAM Timing

Item	Symbol	Min	Typ	Max	Unit
Read cycle time	t_{RC}	24	—	—	ns
Address access time	t_{AA}	—	12	20	ns
Output data hold time	t_{OH}	1	—	—	ns
Read enable time	t_{RON}	—	6	10	ns
Read disable time	t_{ROFF}	0.8	—	—	ns
Write cycle	t_{WC}	24	—	—	ns
Write pulse width	t_{WP}	10	—	—	ns
Address setup time	t_{WAS}	6	—	—	ns
Address hold time	t_{WAH}	8	—	—	ns
Data setup time	t_{WDS}	10	—	—	ns
Data hold time	t_{WDH}	8	—	—	ns
Address latch setup time	t_{GAS}	4	—	—	ns
Address latch hold time	t_{GAH}	2	—	—	ns

Dual-Port RAM

Features

- Two addresses, two R/W ports
- Asynchronous
- Autodiagnosis
- 128 word × 9 bit
64 word × 18 bit
32 word × 36 bit

Notes

- Since the address latch (ADD-L, figure 7) is built in, GA and GB must be open (automatically pulled high) when it is not used.
- Outputs ($OA_0-OA_{b-1}/OB_0-OB_{b-1}$) are high impedance when read enable (RA/RB) is low.
- You cannot write to the same address from both the A and B ports simultaneously.
- Change the address while write enable (WA/WB) is low only.

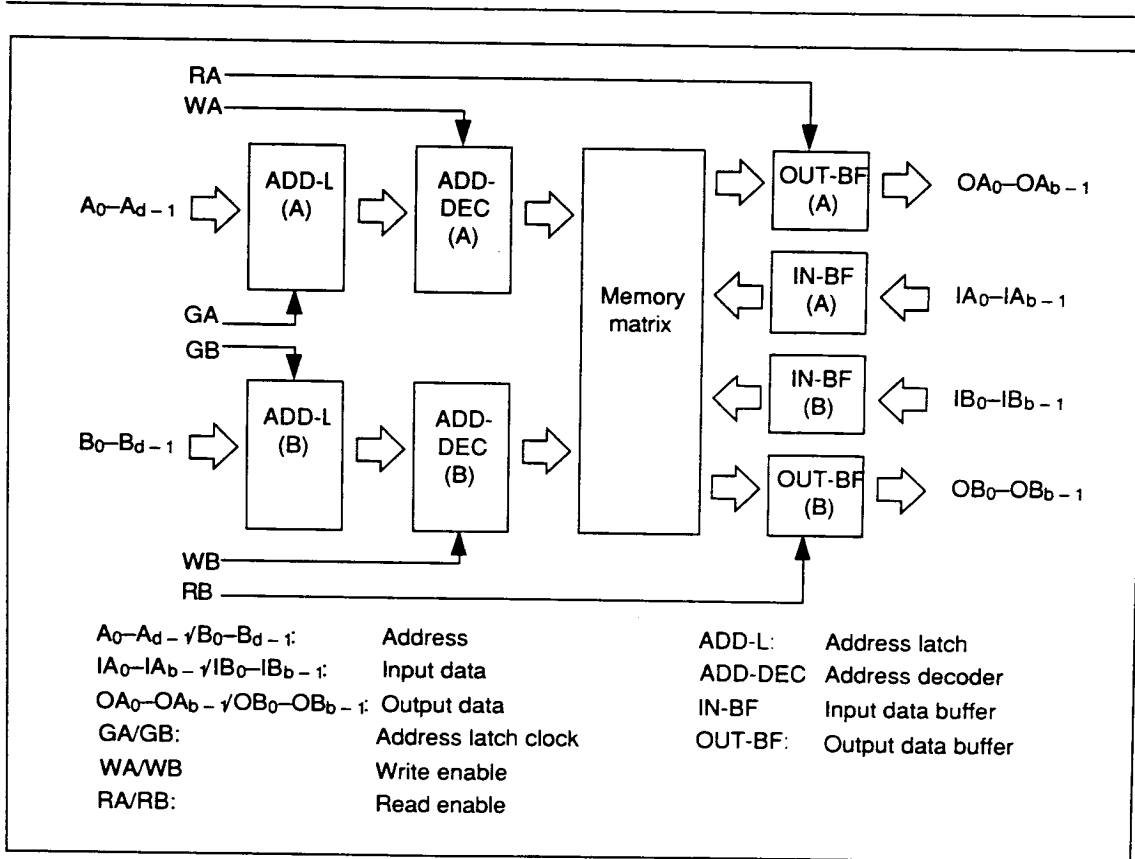

Figure 7 Dual-Port RAM Block Diagram

Absolute Maximum Ratings

Item	Symbol	Rating	Unit
Supply voltage	V_{CC}	-0.3 to +6.7	V
Terminal voltage	Input V_{TI}	-0.3 to $V_{CC} + 0.3$	V
	Output V_{TO}	-0.3 to $V_{CC} + 0.3$	V
Output current	Per output I_O	-32 to +32	mA
	Per V_{CC}/GND I_{OT}	-70 to +70	mA
Operating temperature	T_{opr}	-20 to +75	°C
Storage temperature	With bias T_{bias}	-20 to +85	°C
	Without bias T_{stg}	-55 to +125	°C

Electrical Characteristics

Terminal Capacitance ($T_a = 25^\circ\text{C}$, $f = 1\text{ MHz}$)

Item	Symbol	Min	Typ	Max	Unit	Test Condition
Terminal capacitance	C_T	—	—	125	pF	$V_{IN} = 0\text{ V}$

Note: Terminal capacitance is sampled and not 100% tested.

Normal Temperature Range ($V_{CC} = 5\text{ V} \pm 5\%$, $T_a = 0^\circ\text{C}$ to $+70^\circ\text{C}$)

Item	Symbol	Min	Typ	Max	Unit	Test Condition
Input voltage (TTL level)	V_{IHT}	2.2	—	$V_{CC} + 0.3$	V	
	V_{ILT}	-0.3	—	0.8	V	
Input voltage (CMOS level)	V_{IHC}	$0.7 \times V_{CC}$	—	$V_{CC} + 0.3$	V	
	V_{ILC}	-0.3	—	$0.3 \times V_{CC}$	V	
Schmitt trigger (TTL level)	V_{TT+}	(1.5)	—	2.5	V	$V_{CC} = 5\text{ V}$
	V_{TT-}	0.7	—	(1.7)	V	$V_{CC} = 5\text{ V}$
	ΔV_{TT}	(0.3)	—	—	V	$V_{CC} = 5\text{ V}$
Schmitt trigger (CMOS level)	V_{TC+}	(2.8)	—	4.0	V	$V_{CC} = 5\text{ V}$
	V_{TC-}	1.2	—	(2.4)	V	$V_{CC} = 5\text{ V}$
	ΔV_{TC}	(0.3)	—	—	V	$V_{CC} = 5\text{ V}$
Output voltage ($I_{OL} = 2\text{ mA}$)	V_{OH}	3.5	—	—	V	$I_{OH} = -1\text{ mA}$
	V_{OL}	—	—	0.4	V	$I_{OL} = 2\text{ mA}$
Output voltage ($I_{OL} = 8\text{ mA}$)	V_{OH}	3.5	—	—	V	$I_{OH} = -2\text{ mA}$
	V_{OL}	—	—	0.4	V	$I_{OL} = 8\text{ mA}$
Output voltage ($I_{OL} = 12\text{ mA}$)	V_{OH}	3.5	—	—	V	$I_{OH} = -4\text{ mA}$
	V_{OL}	—	—	0.4	V	$I_{OL} = 12\text{ mA}$

HG62G Series

Normal Temperature Range (cont) ($V_{CC} = 5\text{ V} \pm 5\%$, $T_a = 0^\circ\text{C}$ to $+70^\circ\text{C}$)

Item	Symbol	Min	Typ	Max	Unit	Test Condition	
Output voltage ($I_{OL} = 24\text{ mA}$)	V_{OH}	3.5	—	—	V	$I_{OH} = -12\text{ mA}$	
	V_{OL}	—	—	0.4	V	$I_{OL} = 24\text{ mA}$	
Input leakage current	I_{LI}	—	—	1	μA		
Output leakage current	I_{LO}	—	—	1	μA	At high impedance	
Pull-up current	I_{PU}	80	220	550	μA	$V_{IN} = \text{GND}$	
Pull-down current	I_{PD}	80	220	550	μA	$V_{IN} = V_{CC}$	
Gate delay	Internal	t_{pd}	—	0.3	—	ns	2-input power NAND, FO = 2, AI = 2 mm
	Input buffer	t_{pd}	—	0.8	—	ns	FO = 2, AI = 2 mm
	Output buffer	t_{pd}	—	1.8	—	ns	High-speed buffer $C_L = 50\text{ pF}$
Power dissipation	P_i	—	9	—	$\mu\text{W/gate}$	1 MHz	

Note: Input level may be degraded by GND noise due to numbers of output switching simultaneously.

Extended Temperature Range ($V_{CC} = 5\text{ V} \pm 5\%$, $T_a = -20^\circ\text{C}$ to $+75^\circ\text{C}$)

Item	Symbol	Min	Typ	Max	Unit	Test Condition	
Input voltage (TTL level)	V_{IHT}	2.4	—	$V_{CC} + 0.3$	V		
	V_{ILT}	-0.3	—	0.8	V		
Input voltage (CMOS level)	V_{IHC}	$0.7 \times V_{CC}$	—	$V_{CC} + 0.3$	V		
	V_{ILC}	-0.3	—	$0.3 \times V_{CC}$	V		
Schmitt trigger (TTL level)	V_{TT+}	(1.5)	—	2.5	V	$V_{CC} = 5\text{ V}$	
	V_{TT-}	0.7	—	(1.7)	V	$V_{CC} = 5\text{ V}$	
	ΔV_{TT}	(0.3)	—	—	V	$V_{CC} = 5\text{ V}$	
Schmitt trigger (CMOS level)	V_{TC+}	(2.8)	—	4.0	V	$V_{CC} = 5\text{ V}$	
	V_{TC-}	1.2	—	(2.4)	V	$V_{CC} = 5\text{ V}$	
	ΔV_{TC}	(0.3)	—	—	V	$V_{CC} = 5\text{ V}$	
Output voltage ($I_{OL} = 2\text{ mA}$)	V_{OH}	3.5	—	—	V	$I_{OH} = -1\text{ mA}$	
	V_{OL}	—	—	0.4	V	$I_{OL} = 2\text{ mA}$	
Output voltage ($I_{OL} = 8\text{ mA}$)	V_{OH}	3.5	—	—	V	$I_{OH} = -2\text{ mA}$	
	V_{OL}	—	—	0.4	V	$I_{OL} = 8\text{ mA}$	
Output voltage ($I_{OL} = 12\text{ mA}$)	V_{OH}	3.5	—	—	V	$I_{OH} = -4\text{ mA}$	
	V_{OL}	—	—	0.4	V	$I_{OL} = 12\text{ mA}$	
Output voltage ($I_{OL} = 24\text{ mA}$)	V_{OH}	3.5	—	—	V	$I_{OH} = -12\text{ mA}$	
	V_{OL}	—	—	0.4	V	$I_{OL} = 24\text{ mA}$	
Input leakage current	I_{LI}	—	—	1	μA		
Output leakage current	I_{LO}	—	—	1	μA	At high impedance	
Pull-up current	I_{PU}	80	220	550	μA	$V_{IN} = \text{GND}$	
Pull-down current	I_{PD}	80	220	550	μA	$V_{IN} = V_{CC}$	
Gate delay	Internal	t_{pd}	—	0.3	—	ns	2-input power NAND, FO = 2, AI = 2 mm
	Input buffer	t_{pd}	—	0.8	—	ns	FO = 2, AI = 2 mm
	Output buffer	t_{pd}	—	1.8	—	ns	High-speed buffer $C_L = 50\text{ pF}$
Power dissipation	P_i	—	9	—	$\mu\text{W/gate}$	1 MHz	

Note: Input level may be degraded by GND noise due to numbers of output switching simultaneously.

Characteristic Curves

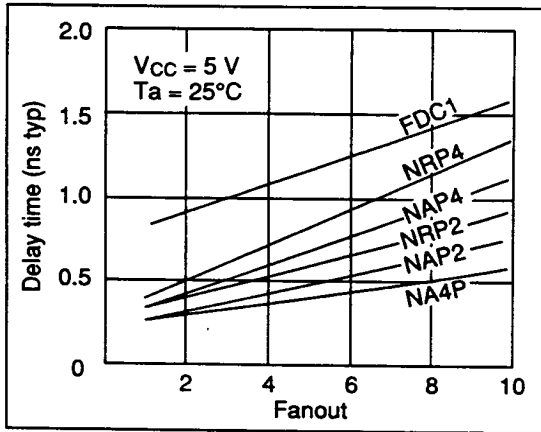

Figure 12 Internal Gate Delay Time

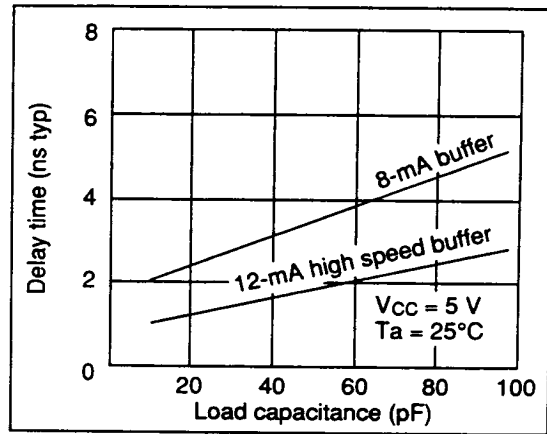

Figure 13 Output Buffer Delay Time

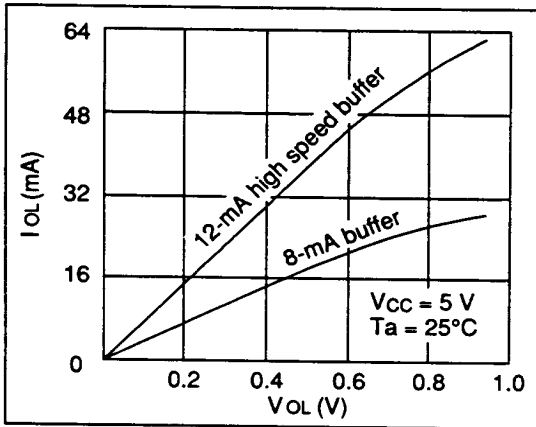

Figure 14 Output Current Characteristics ($V_{OL}-I_{OL}$)

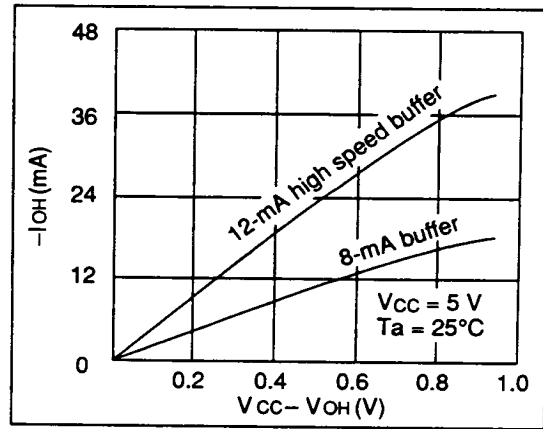
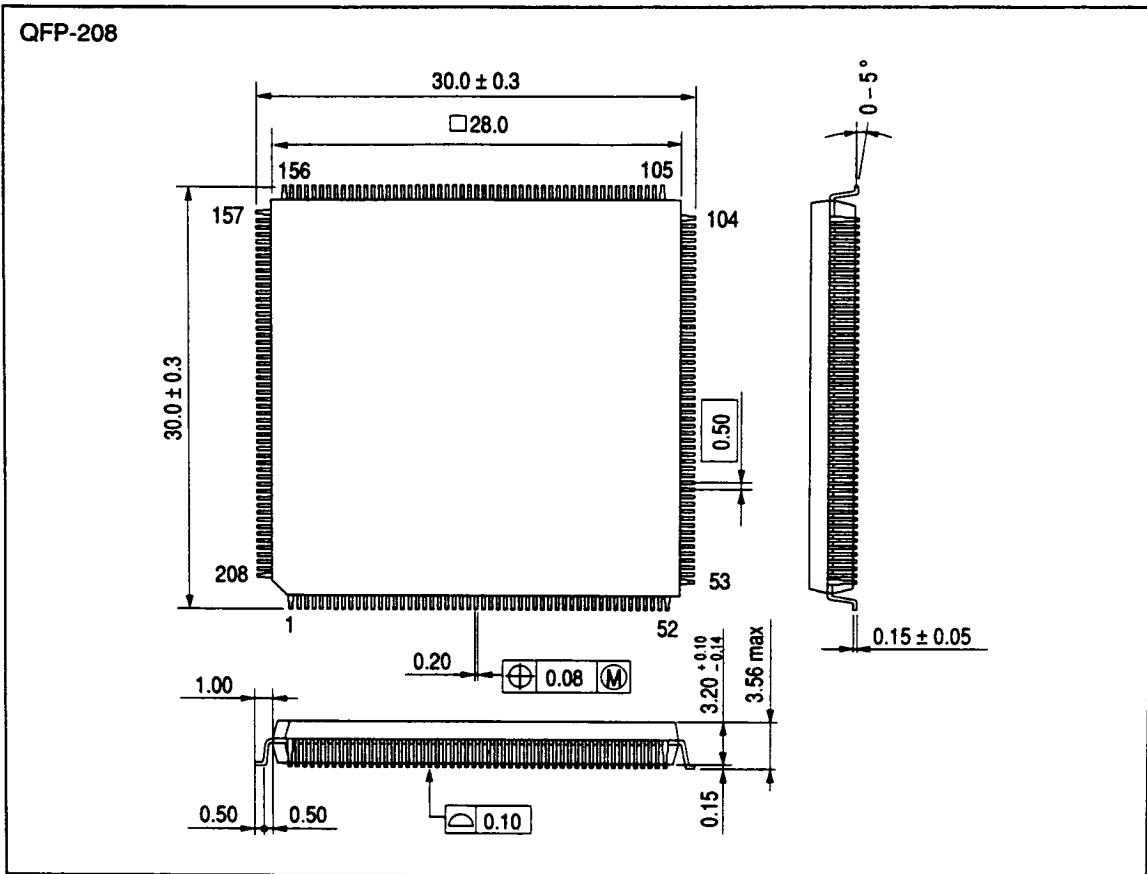

Figure 15 Output Current Characteristics ($V_{OH}-I_{OH}$)

HG62G Series



When using this document, keep the following in mind:

1. This document may, wholly or partially, be subject to change without notice.
2. All rights are reserved: No one is permitted to reproduce or duplicate, in any form, the whole or part of this document without Hitachi's permission.
3. Hitachi will not be held responsible for any damage to the user that may result from accidents or any other reasons during operation of the user's unit according to this document.
4. Circuitry and other examples described herein are meant merely to indicate the characteristics and performance of Hitachi's semiconductor products. Hitachi assumes no responsibility for any intellectual property claims or other problems that may result from applications based on the examples described herein.
5. No license is granted by implication or otherwise under any patents or other rights of any third party or Hitachi, Ltd.
6. **MEDICAL APPLICATIONS:** Hitachi's products are not authorized for use in **MEDICAL APPLICATIONS** without the written consent of the appropriate officer of Hitachi's sales company. Such use includes, but is not limited to, use in life support systems. Buyers of Hitachi's products are requested to notify the relevant Hitachi sales offices when planning to use the products in **MEDICAL APPLICATIONS**.



Hitachi, Ltd.

Semiconductor & IC Div.
Karukozaka MN Bldg., 2-1, Ageba-cho, Shinjuku-ku, Tokyo 162, Japan
Tel: Tokyo (03) 3266-9376
Fax: (03) 3235-2375

For further information write to:

Hitachi America, Ltd.
Semiconductor & IC Div.
2000 Sierra Point Parkway
Brisbane, CA. 94005-1819
U S A
Tel: 415-589-8300
Fax: 415-583-4207

Hitachi Europe GmbH
Electronic Components Div.
Central Europe Headquarters
Hans-Pinsel-Straße 10A
8013 Haar bei München
F. R. Germany
Tel: 089-46140
Fax: 089-463068

Hitachi Europe Ltd.
Electronic Components Div.
Northern Europe Headquarters
Whitebrook Park
Lower Cookham Road
Maidenhead
Berkshire SL6 8YA
United Kingdom
Tel: 0628-585000
Fax: 0628-778322

Hitachi Asia (Hong Kong) Ltd.
Unit 706, North Tower,
World Finance Centre,
Harbour City, Canton Road
Tsimshatsui, Kowloon
Hong Kong
Tel: 852-7359218
Fax: 852-7306071

105

FEB 0 4 1992

026962 ✓ R

M31T014