

NCP552, NCP553

80 mA CMOS Low Iq NOCAP™ Voltage Regulator

This series of fixed output NOCAP linear regulators are designed for handheld communication equipment and portable battery powered applications which require low quiescent. This series features an ultra-low quiescent current of 2.8 μ A. Each device contains a voltage reference unit, an error amplifier, a PMOS power transistor, resistors for setting output voltage, current limit, and temperature limit protection circuits. The NCP552 series provides an enable pin for ON/OFF control.

These voltage regulators have been designed to be used with low cost ceramic capacitors. The devices have the ability to operate without an output capacitor. The devices are housed in the micro-miniature SC82-AB surface mount package. Standard voltage versions are 1.5, 1.8, 2.5, 2.7, 2.8, 3.0, 3.3, and 5.0 V. Other voltages are available in 100 mV steps.

Features

- Low Quiescent Current of 2.8 μ A Typical
- Low Output Voltage Option
- Output Voltage Accuracy of 2.0%
- Industrial Temperature Range of -40°C to 85°C
- NCP552 Provides an Enable Pin

Typical Applications

- Battery Powered Consumer Products
- Hand-Held Instruments
- Camcorders and Cameras

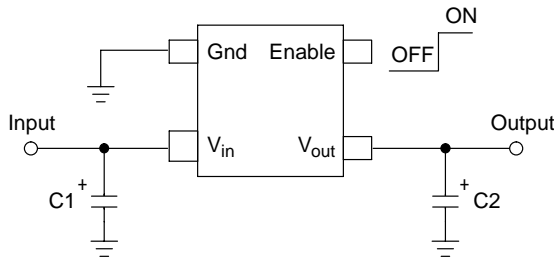

This device contains 32 active transistors

Figure 1. NCP552 Typical Application Diagram

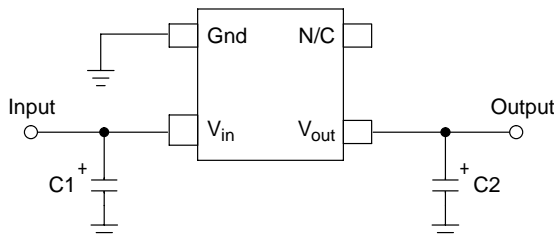

This device contains 32 active transistors

Figure 2. NCP553 Typical Application Diagram



ON Semiconductor®

<http://onsemi.com>

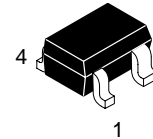

SC82-AB (SC70-4)
SQ SUFFIX
CASE 419C

PIN CONNECTIONS & MARKING DIAGRAMS

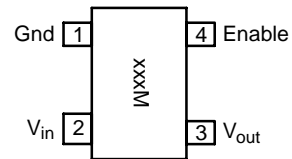

(NCP552 Top View)

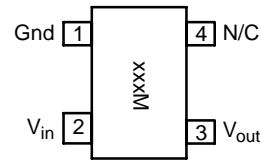

(NCP553 Top View)

xxx = Device Code
M = Date Code

ORDERING INFORMATION

See detailed ordering and shipping information in the package dimensions section on page 9 of this data sheet.

NCP552, NCP553

PIN FUNCTION DESCRIPTION

NCP552	NCP553	Pin Name	Description
1	1	Gnd	Power supply ground.
2	2	Vin	Positive power supply input voltage.
3	3	Vout	Regulated output voltage.
4	–	Enable	This input is used to place the device into low–power standby. When this input is pulled low, the device is disabled. If this function is not used, Enable should be connected to Vin.
–	4	N/C	No internal connection.

MAXIMUM RATINGS

Rating	Symbol	Value	Unit
Input Voltage	V_{in}	12	V
Enable Voltage (NCP552 ONLY)	Enable	–0.3 to $V_{in} + 0.3$	V
Output Voltage	V_{out}	–0.3 to $V_{in} + 0.3$	V
Power Dissipation and Thermal Characteristics Power Dissipation Thermal Resistance, Junction to Ambient	P_D $R_{\theta JA}$	Internally Limited 400	W °C/W
Operating Junction Temperature	T_J	+125	°C
Operating Ambient Temperature	T_A	–40 to +85	°C
Storage Temperature	T_{stg}	–55 to +150	°C

1. This device series contains ESD protection and exceeds the following tests:
Human Body Model 2000 V per MIL–STD–883, Method 3015
Machine Model Method 200 V
2. Latch up capability (85°C) ± 200 mA DC with trigger voltage.

NCP552, NCP553

ELECTRICAL CHARACTERISTICS ($V_{in} = V_{out(nom.)} + 1.0\text{ V}$, $V_{enable} = V_{in}$, $C_{in} = 1.0\ \mu\text{F}$, $C_{out} = 1.0\ \mu\text{F}$, $T_J = 25^\circ\text{C}$, unless otherwise noted.)

Characteristic	Symbol	Min	Typ	Max	Unit
Output Voltage ($T_A = 25^\circ\text{C}$, $I_{out} = 10\text{ mA}$) 1.5 V 1.8 V 2.5 V 2.7 V 2.8 V 3.0 V 3.3 V 5.0 V	V_{out}	1.455 1.746 2.425 2.646 2.744 2.94 3.234 4.900	1.5 1.8 2.5 2.7 2.8 3.0 3.3 5.0	1.545 1.854 2.575 2.754 2.856 3.06 3.366 5.100	V
Output Voltage ($T_A = -40^\circ\text{C}$ to 85°C , $I_{out} = 10\text{ mA}$) 1.5 V 1.8 V 2.5 V 2.7 V 2.8 V 3.0 V 3.3 V 5.0 V	V_{out}	1.455 1.746 2.425 2.619 2.716 2.910 3.201 4.900	1.5 1.8 2.5 2.7 2.8 3.0 3.3 5.0	1.545 1.854 2.575 2.781 2.884 3.09 3.399 5.100	V
Line Regulation ($V_{in} = V_{out} + 1.0\text{ V}$ to 12 V , $I_{out} = 10\text{ mA}$)	Reg_{line}	–	2.0	4.5	mV/V
Load Regulation ($I_{out} = 1.0\text{ mA}$ to 80 mA , $V_{in} = V_{out} + 2.0\text{ V}$)	Reg_{load}	–	0.3	0.8	mV/mA
Output Current ($V_{out} = (V_{out}$ at $I_{out} = 80\text{ mA}) - 3.0\%$) 1.5 V–3.9 V ($V_{in} = V_{out(nom.)} + 2.0\text{ V}$) 4.0 V–5.0 V ($V_{in} = 6.0\text{ V}$)	$I_{o(nom.)}$	80 80	180 180	– –	mA
Dropout Voltage ($T_A = -40^\circ\text{C}$ to 85°C , $I_{out} = 80\text{ mA}$, Measured at $V_{out} - 3.0\%$) 1.5 V 1.8 V 2.5 V 2.7 V 2.8 V 3.0 V 3.3 V 5.0 V	$V_{in} - V_{out}$	– – – – – – – –	1300 1100 800 750 730 680 650 470	1800 1600 1400 1200 1200 1000 1000 800	mV
Quiescent Current (Enable Input = 0 V) (Enable Input = V_{in} , $I_{out} = 1.0\text{ mA}$ to $I_{o(nom.)}$, $V_{in} = V_{out} + 2.0\text{ V}$)	I_Q	– –	0.1 2.8	1.0 6.0	μA
Output Short Circuit Current ($V_{out} = 0\text{ V}$) 1.5 V–3.9 V ($V_{in} = V_{out(nom.)} + 2.0\text{ V}$) 4.0 V–5.0 V ($V_{in} = 6.0\text{ V}$)	$I_{out(max)}$	100 100	300 300	450 450	mA
Output Voltage Noise ($f = 20\text{ Hz}$ to 100 kHz , $I_{out} = 10\text{ mA}$) ($C_{out} = 1.0\ \mu\text{F}$)	V_n	–	90	–	μV_{rms}
Enable Input Threshold Voltage (NCP552 ONLY) (Voltage Increasing, Output Turns On, Logic High) (Voltage Decreasing, Output Turns Off, Logic Low)	$V_{th(en)}$	1.3 –	– –	– 0.3	V
Output Voltage Temperature Coefficient	T_C	–	± 100	–	ppm/ $^\circ\text{C}$

3. Maximum package power dissipation limits must be observed.

$$PD = \frac{T_{J(max)} - T_A}{R_{\theta JA}}$$

4. Low duty cycle pulse techniques are used during testing to maintain the junction temperature as close to ambient as possible.

DEFINITIONS

Load Regulation

The change in output voltage for a change in output current at a constant temperature.

Dropout Voltage

The input/output differential at which the regulator output no longer maintains regulation against further reductions in input voltage. Measured when the output drops 3.0% below its nominal. The junction temperature, load current, and minimum input supply requirements affect the dropout level.

Maximum Power Dissipation

The maximum total dissipation for which the regulator will operate within its specifications.

Quiescent Current

The quiescent current is the current which flows through the ground when the LDO operates without a load on its output: internal IC operation, bias, etc. When the LDO becomes loaded, this term is called the Ground current. It is actually the difference between the input current (measured through the LDO input pin) and the output current.

Line Regulation

The change in output voltage for a change in input voltage. The measurement is made under conditions of low dissipation or by using pulse technique such that the average chip temperature is not significantly affected.

Line Transient Response

Typical over and undershoot response when input voltage is excited with a given slope.

Thermal Protection

Internal thermal shutdown circuitry is provided to protect the integrated circuit in the event that the maximum junction temperature is exceeded. When activated at typically 160°C, the regulator turns off. This feature is provided to prevent failures from accidental overheating.

Maximum Package Power Dissipation

The maximum power package dissipation is the power dissipation level at which the junction temperature reaches its maximum operating value, i.e. 125°C. Depending on the ambient power dissipation and thus the maximum available output current.

NCP552, NCP553

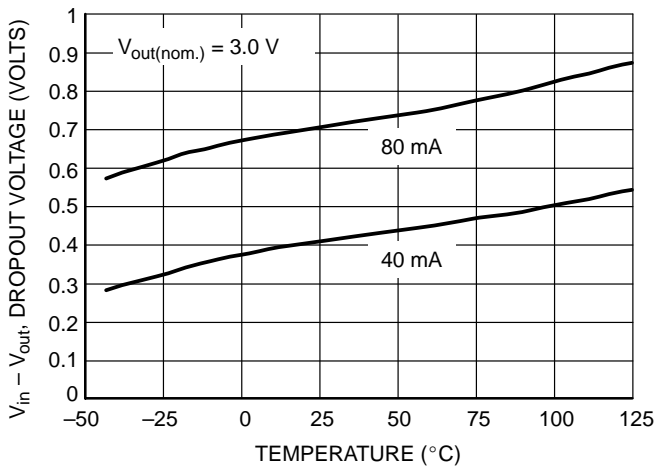

Figure 3. Dropout Voltage versus Temperature

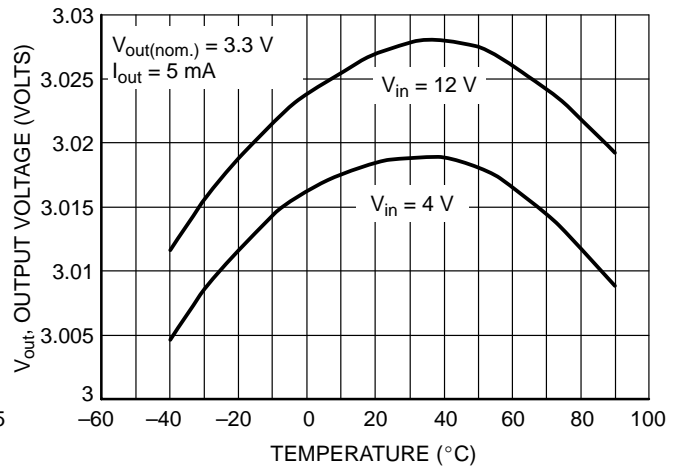

Figure 4. Output Voltage versus Temperature

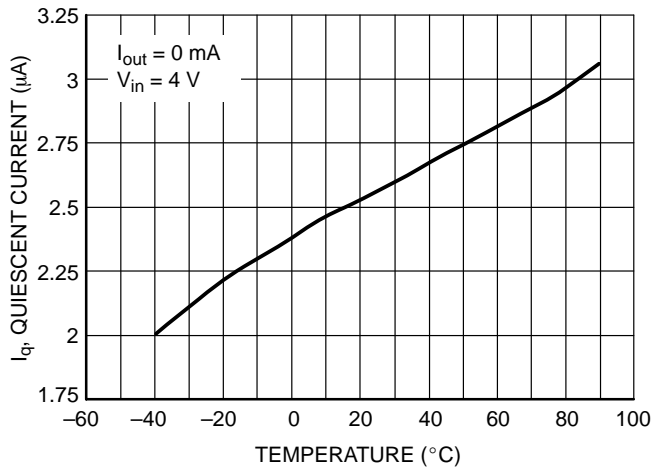

Figure 5. Quiescent Current versus Temperature

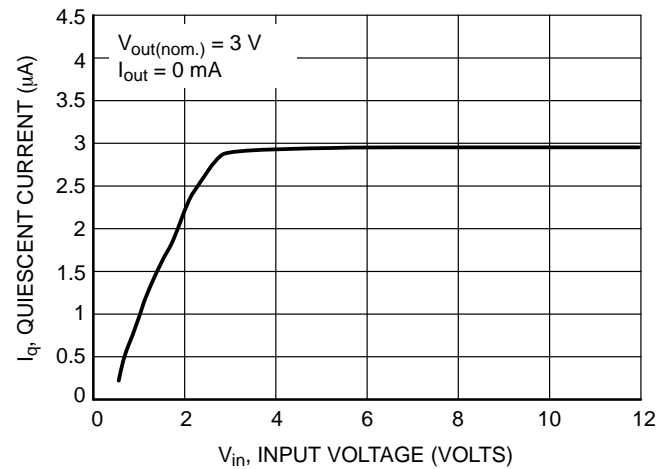

Figure 6. Quiescent Current versus Input Voltage

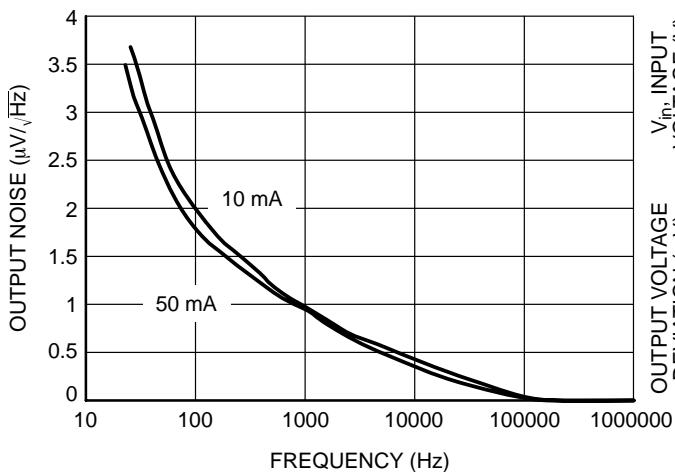

Figure 7. Output Noise Density

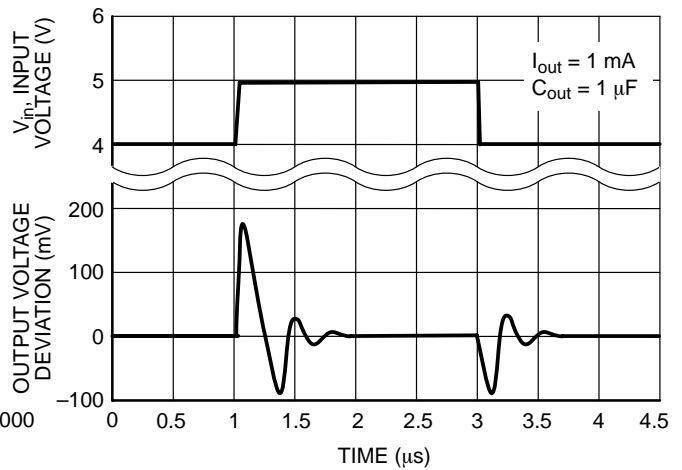

Figure 8. Line Transient Response

NCP552, NCP553

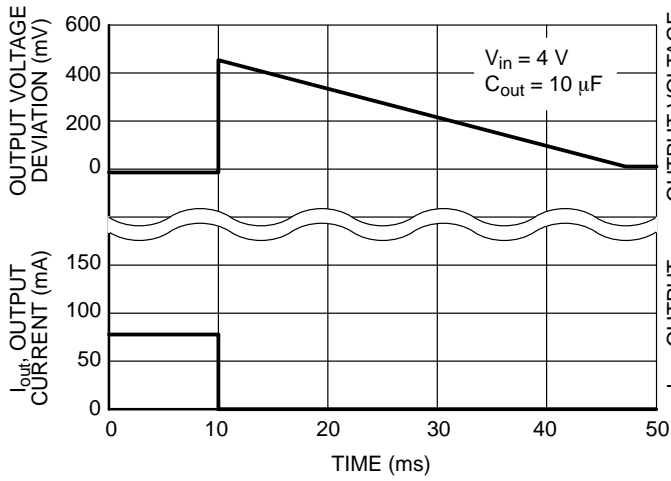

Figure 9. Load Transient Response

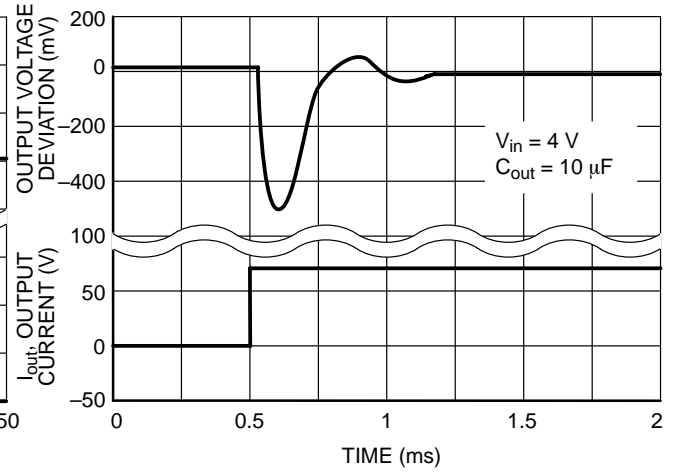

Figure 10. Load Transient Response

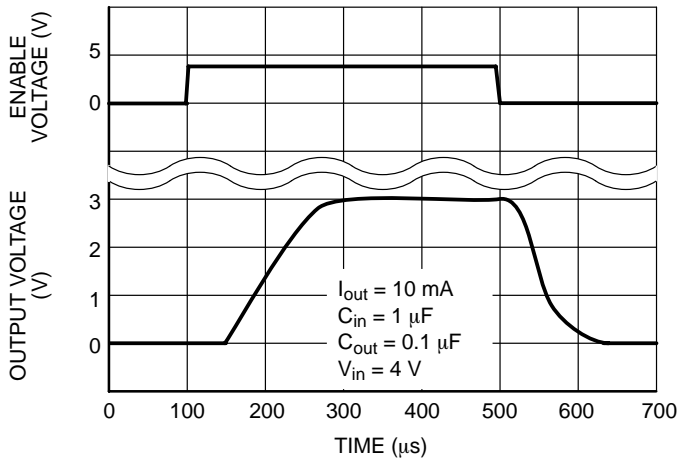

Figure 11. Turn-On Response (NCP552 ONLY)

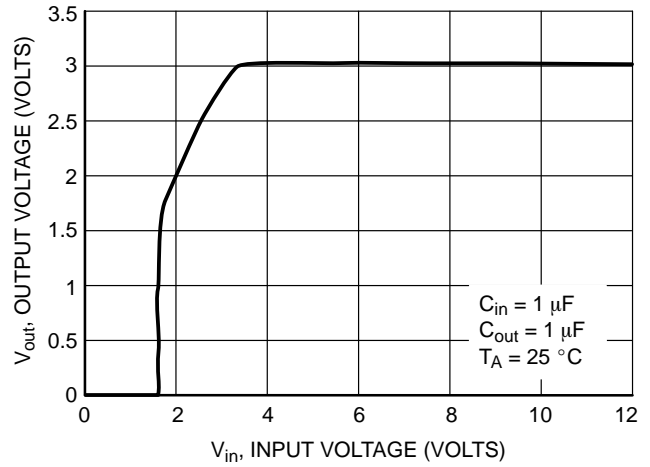

Figure 12. Output Voltage versus Input Voltage

APPLICATIONS INFORMATION

A typical application circuit for the NCP552 series and NCP553 series is shown in Figure 1 and Figure 2, front page.

Input Decoupling (C1)

A 1.0 μF capacitor either ceramic or tantalum is recommended and should be connected close to the package. Higher values and lower ESR will improve the overall line transient response. If large line or load transients are not expected, then it is possible to operate the regulator without the use of a capacitor.

TDK capacitor: C2012X5R1C105K, or C1608X5R1A105K

Output Decoupling (C2)

The NCP552 and NCP553 are very stable regulators and do not require any specific Equivalent Series Resistance (ESR) or a minimum output current. If load transients are not to be expected, then it is possible for the regulator to operate with no output capacitor. Otherwise, capacitors exhibiting ESRs ranging from a few $\text{m}\Omega$ up to $10\ \Omega$ can thus safely be used. The minimum decoupling value is $0.1\ \mu\text{F}$ and can be augmented to fulfill stringent load transient requirements. The regulator accepts ceramic chip capacitors as well as tantalum devices. Larger values improve noise rejection and load regulation transient response.

TDK capacitor: C2012X5R1C105K, C1608X5R1A105K, or C3216X7R1C105K

Enable Operation (NCP552 ONLY)

The enable pin will turn on the regulator when pulled high and turn off the regulator when pulled low. These limits of threshold are covered in the electrical specification section of this data sheet. If the enable is not used then the pin should be connected to V_{in} .

Hints

Please be sure the V_{in} and Gnd lines are sufficiently wide. When the impedance of these lines is high, there is a chance to pick up noise or cause the regulator to malfunction.

Set external components, especially the output capacitor, as close as possible to the circuit, and make leads as short as possible.

Thermal

As power across the NCP552 and NCP553 increases, it might become necessary to provide some thermal relief. The maximum power dissipation supported by the device is dependent upon board design and layout. Mounting pad configuration on the PCB, the board material and also the ambient temperature effect the rate of temperature rise for the part. This is stating that when the devices have good thermal conductivity through the PCB, the junction temperature will be relatively low with high power dissipation applications.

The maximum dissipation the package can handle is given by:

$$PD = \frac{T_{J(\text{max})} - T_A}{R_{\theta JA}}$$

If junction temperature is not allowed above the maximum 125°C , then the NCP552 and NCP553 can dissipate up to $250\ \text{mW}$ @ 25°C .

The power dissipated by the NCP552 and NCP553 can be calculated from the following equation:

$$P_{\text{tot}} = [V_{\text{in}} * I_{\text{gnd}} (I_{\text{out}})] + [V_{\text{in}} - V_{\text{out}}] * I_{\text{out}}$$

or

$$V_{\text{inMAX}} = \frac{P_{\text{tot}} + V_{\text{out}} * I_{\text{out}}}{I_{\text{gnd}} + I_{\text{out}}}$$

If an $80\ \text{mA}$ output current is needed then the ground current from the data sheet is $2.8\ \mu\text{A}$. For an NCP552 or NCP553 ($3.0\ \text{V}$), the maximum input voltage will then be $6.12\ \text{V}$.

INFORMATION FOR USING THE SC-82AB SURFACE MOUNT PACKAGE

MINIMUM RECOMMENDED FOOTPRINT FOR SURFACE MOUNTED APPLICATIONS

Surface mount board layout is a critical portion of the total design. The footprint for the semiconductor packages must be the correct size to insure proper solder connection

interface between the board and the package. With the correct pad geometry, the packages will self align when subjected to a solder reflow process.

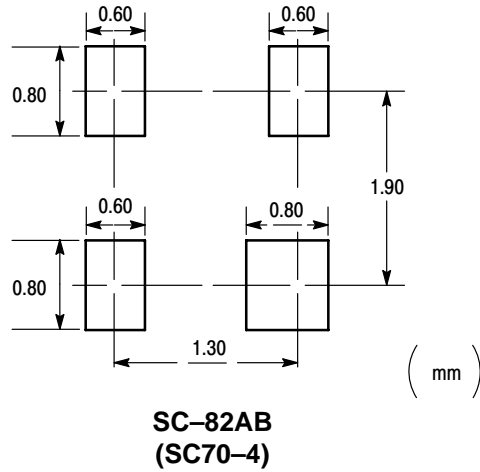

NCP552, NCP553

ORDERING INFORMATION

Device	Nominal Output Voltage	Marking	Package	Shipping
NCP552SQ15T1	1.5	LAW	SC82-AB (SC70-4)	3000 Units/ 8" Tape & Reel
NCP552SQ18T1	1.8	LAX		
NCP552SQ25T1	2.5	LAY		
NCP552SQ27T1	2.7	LAZ		
NCP552SQ28T1	2.8	LBA		
NCP552SQ30T1	3.0	LBB		
NCP552SQ33T1	3.3	LBC		
NCP552SQ50T1	5.0	LBD		
NCP553SQ15T1	1.5	LBE	SC82-AB (SC70-4)	3000 Units/ 8" Tape & Reel
NCP553SQ18T1	1.8	LBF		
NCP553SQ25T1	2.5	LBG		
NCP553SQ27T1	2.7	LBH		
NCP553SQ28T1	2.8	LBI		
NCP553SQ30T1	3.0	LBJ		
NCP553SQ33T1	3.3	LBK		
NCP553SQ50T1	5.0	LBL		

Additional voltages in 100 mV steps are available upon request by contacting your ON Semiconductor representative.

NCP552, NCP553

PACKAGE DIMENSIONS

SC82-AB (SC70-4)
SQ SUFFIX
CASE 419C-01
ISSUE A

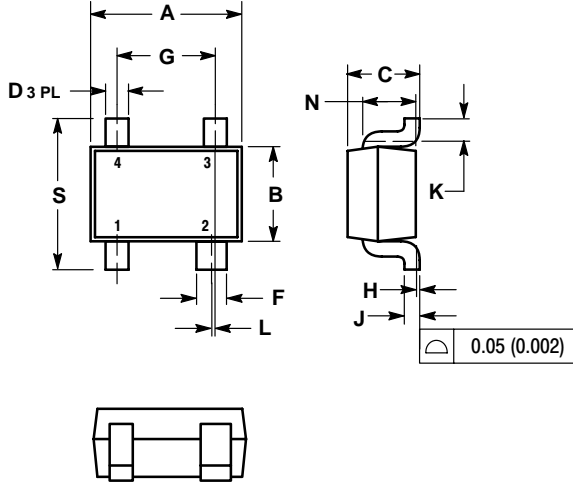

- NOTES:
1. DIMENSIONING AND TOLERANCING PER ANSI Y14.5M, 1982.
2. CONTROLLING DIMENSION: MILLIMETER.

DIM	MILLIMETERS		INCHES	
	MIN	MAX	MIN	MAX
A	1.8	2.2	0.071	0.087
B	1.15	1.45	0.045	0.057
C	0.8	1.1	0.031	0.043
D	0.2	0.4	0.008	0.016
F	0.3	0.5	0.012	0.020
G	1.1	1.5	0.043	0.059
H	0.0	0.1	0.000	0.004
J	0.10	0.26	0.004	0.010
K	0.1	---	0.004	---
L	0.05 BSC		0.002 BSC	
N	0.7 REF		0.028 REF	
S	1.8	2.4	0.07	0.09

Notes

NCP552, NCP553

NOCAP is a trademark of Semiconductor Components Industries, LLC.

ON Semiconductor and  are registered trademarks of Semiconductor Components Industries, LLC (SCILLC). SCILLC reserves the right to make changes without further notice to any products herein. SCILLC makes no warranty, representation or guarantee regarding the suitability of its products for any particular purpose, nor does SCILLC assume any liability arising out of the application or use of any product or circuit, and specifically disclaims any and all liability, including without limitation special, consequential or incidental damages. "Typical" parameters which may be provided in SCILLC data sheets and/or specifications can and do vary in different applications and actual performance may vary over time. All operating parameters, including "Typicals" must be validated for each customer application by customer's technical experts. SCILLC does not convey any license under its patent rights nor the rights of others. SCILLC products are not designed, intended, or authorized for use as components in systems intended for surgical implant into the body, or other applications intended to support or sustain life, or for any other application in which the failure of the SCILLC product could create a situation where personal injury or death may occur. Should Buyer purchase or use SCILLC products for any such unintended or unauthorized application, Buyer shall indemnify and hold SCILLC and its officers, employees, subsidiaries, affiliates, and distributors harmless against all claims, costs, damages, and expenses, and reasonable attorney fees arising out of, directly or indirectly, any claim of personal injury or death associated with such unintended or unauthorized use, even if such claim alleges that SCILLC was negligent regarding the design or manufacture of the part. SCILLC is an Equal Opportunity/Affirmative Action Employer.

PUBLICATION ORDERING INFORMATION

Literature Fulfillment:

Literature Distribution Center for ON Semiconductor
P.O. Box 5163, Denver, Colorado 80217 USA
Phone: 303-675-2175 or 800-344-3860 Toll Free USA/Canada
Fax: 303-675-2176 or 800-344-3867 Toll Free USA/Canada
Email: ONlit@hibbertco.com

N. American Technical Support: 800-282-9855 Toll Free USA/Canada

JAPAN: ON Semiconductor, Japan Customer Focus Center
4-32-1 Nishi-Gotanda, Shinagawa-ku, Tokyo, Japan 141-0031
Phone: 81-3-5740-2700
Email: r14525@onsemi.com

ON Semiconductor Website: <http://onsemi.com>

For additional information, please contact your local Sales Representative.