



BSS84DW

DUAL P-CHANNEL ENHANCEMENT MODE MOSFET

This device contains two electrically-isolated P-channel, enhancement-mode MOSFETs, housed in a very small SOT-363 (SC70-6L) package. This device is ideal for portable applications where board space is at a premium.

FEATURES

- Low On-Resistance
- Low Gate Threshold Voltage
- Fast Switching
- Available in lead-free plating (100% matte tin finish)

APPLICATIONS

- Switching Power Supplies
- Hand-Held Computers, PDAs

MARKING CODE: S84

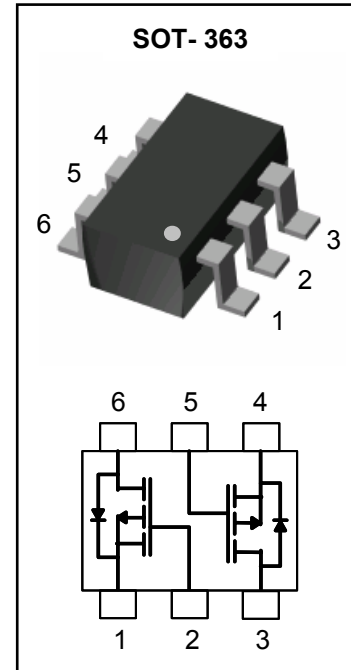

MAXIMUM RATINGS T_J = 25°C Unless otherwise noted

Rating	Symbol	Value	Units
Drain-Source Voltage	V _{DSS}	- 50	V
Drain-Gate Voltage (Note 1)	V _{DGR}	- 50	V
Gate-Source Voltage	V _{GSS}	± 20	V
Drain Current	I _D	130	mA
Total Power Dissipation (Note 2)	P _D	200	mW
Operating Junction Temperature Range	T _J	-55 to +150	°C
Storage Temperature Range	T _{stg}	-55 to +150	°C

Note 1. R_{GS} < 20K ohms

THERMAL CHARACTERISTICS

Characteristic	Symbol	Value	Units
Thermal Resistance, Junction to Ambient (Note 2)	R _{thja}	625	°C/W

Note 2. FR-5 board 1.0 x 0.75 x 0.062 inch with minimum recommended pad layout



Electrical Characteristics (Each Device)

$T_J = 25^\circ\text{C}$ Unless otherwise noted

OFF CHARACTERISTICS (Note 3)

Parameter	Symbol	Conditions	Min	Typ	Max	Units
Drain-Source Breakdown Voltage	BV_{DSS}	$I_D = -250\mu\text{A}, V_{GS} = 0\text{V}$	-50	-	-	V
Zero Gate Voltage Drain Current	I_{DSS}	$V_{DS} = -50\text{V}, V_{GS} = 0\text{V}, T_J = 25^\circ\text{C}$	-	-	-15	μA
		$V_{DS} = -50\text{V}, V_{GS} = 0\text{V}, T_J = 125^\circ\text{C}$	-	-	-60	
		$V_{DS} = -25\text{V}, V_{GS} = 0\text{V}, T_J = 25^\circ\text{C}$	-	-	-0.1	
Gate-Body Leakage	I_{GSS}	$V_{GS} = \pm 20\text{V}, V_{DS} = 0\text{V}$	-	-	± 10	nA

ON CHARACTERISTICS (Note 3)

Parameter	Symbol	Conditions	Min	Typ	Max	Units
Gate Threshold Voltage	$V_{GS(th)}$	$V_{DS} = V_{GS}, I_D = -1\text{mA}$	-0.8	-1.44	-2.0	V
Static Drain-Source On-Resistance	$R_{DS(on)}$	$V_{GS} = -5\text{V}, I_D = -0.1\text{A}$	-	3.8	10	Ohms
Forward Transconductance	g_{FS}	$V_{DS} = -25\text{V}, I_D = -0.1\text{A}$	0.05	-	-	S

DYNAMIC CHARACTERISTICS

Parameter	Symbol	Conditions	Min	Typ	Max	Units
Input Capacitance	C_{iss}	$V_{DS} = -25\text{V}, V_{GS} = 0\text{V}, f = 1.0\text{MHz}$	-	-	45	pF
Output Capacitance	C_{oss}		-	-	25	pF
Reverse Transfer Capacitance	C_{rss}		-	-	12	pF

SWITCHING CHARACTERISTICS

Parameter	Symbol	Conditions	Min	Typ	Max	Units
Turn-On Delay Time	$t_{D(ON)}$	$V_{DD} = -30\text{V}, I_D = -0.27\text{A}, R_{GEN} = 50\text{ohm}, V_{GS} = -10\text{V}$	-	7.5	-	ns
Turn-Off Delay Time	$t_{D(OFF)}$		-	25	-	ns

Note 3. Short duration test pulse used to minimize self-heating



Electrical Characteristic Curves (Each Device)

$T_J = 25^\circ\text{C}$ Unless otherwise noted

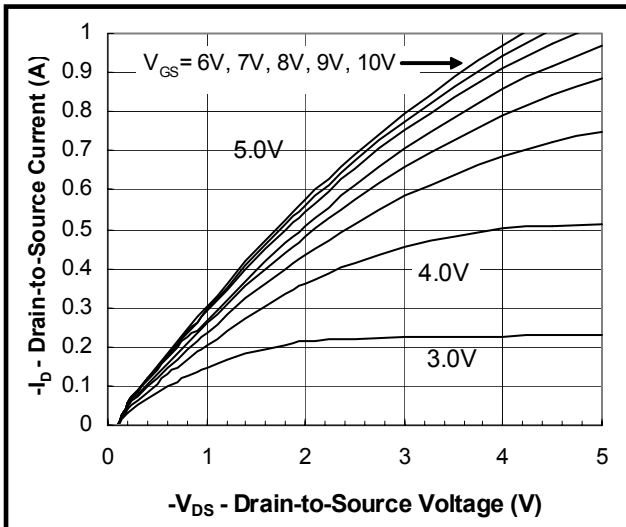

Fig. 1. Output Characteristics

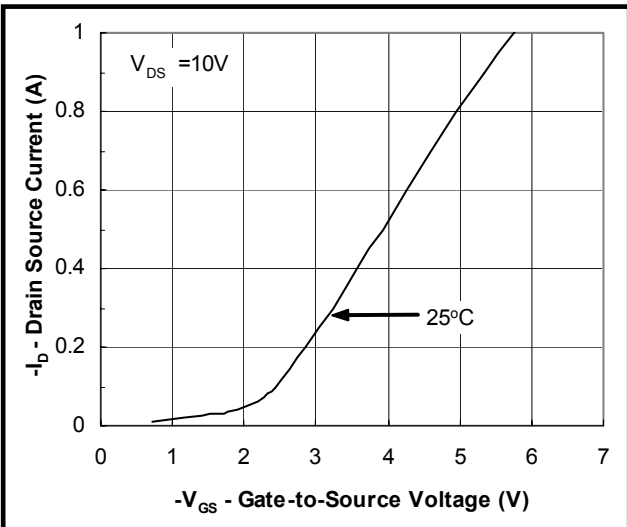

Fig. 2. Transfer Characteristics

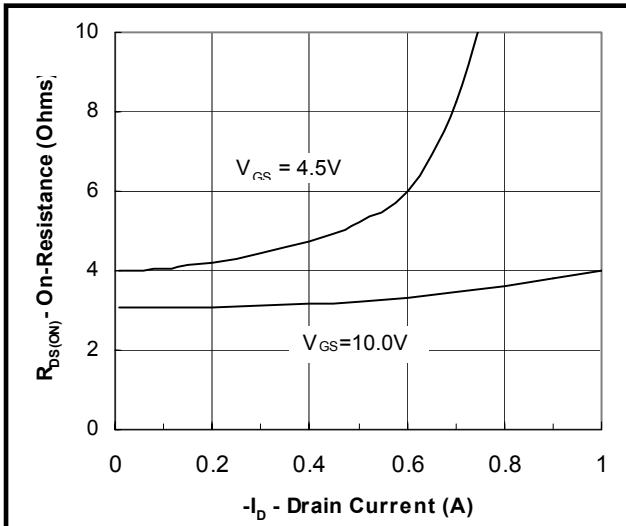

Fig. 3. On-Resistance vs. Drain Current

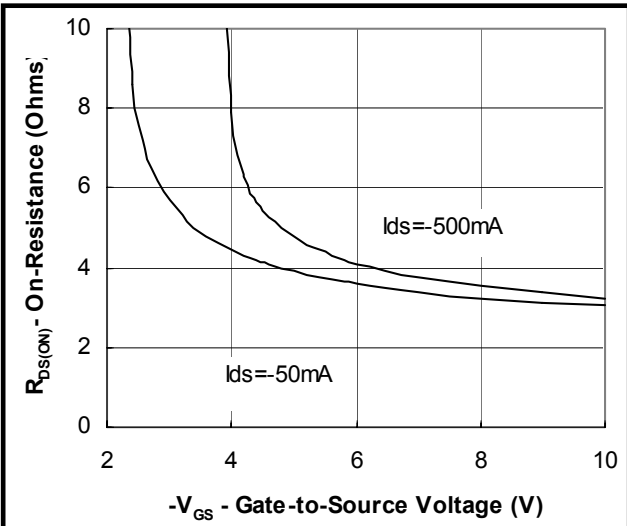

Fig. 4. On-Resistance vs. G-S Voltage

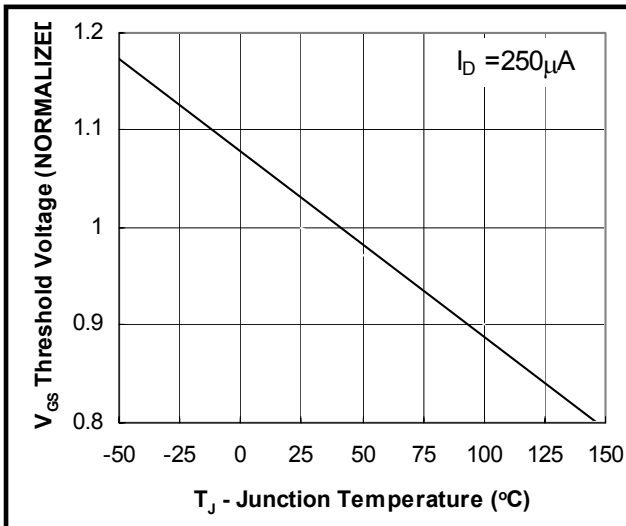

Fig. 5. Threshold Voltage vs. Temperature

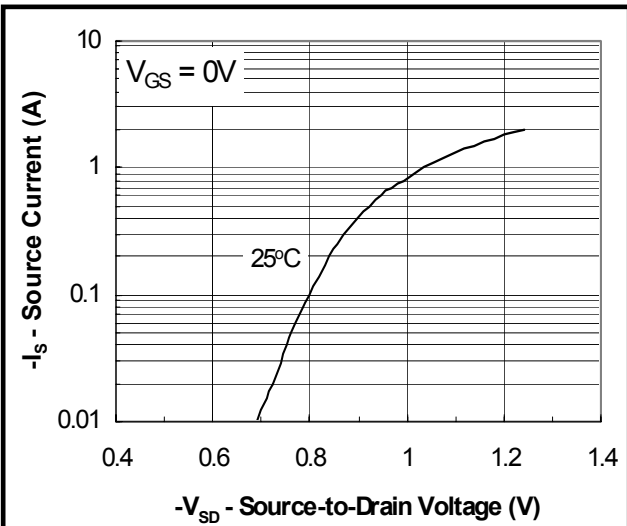
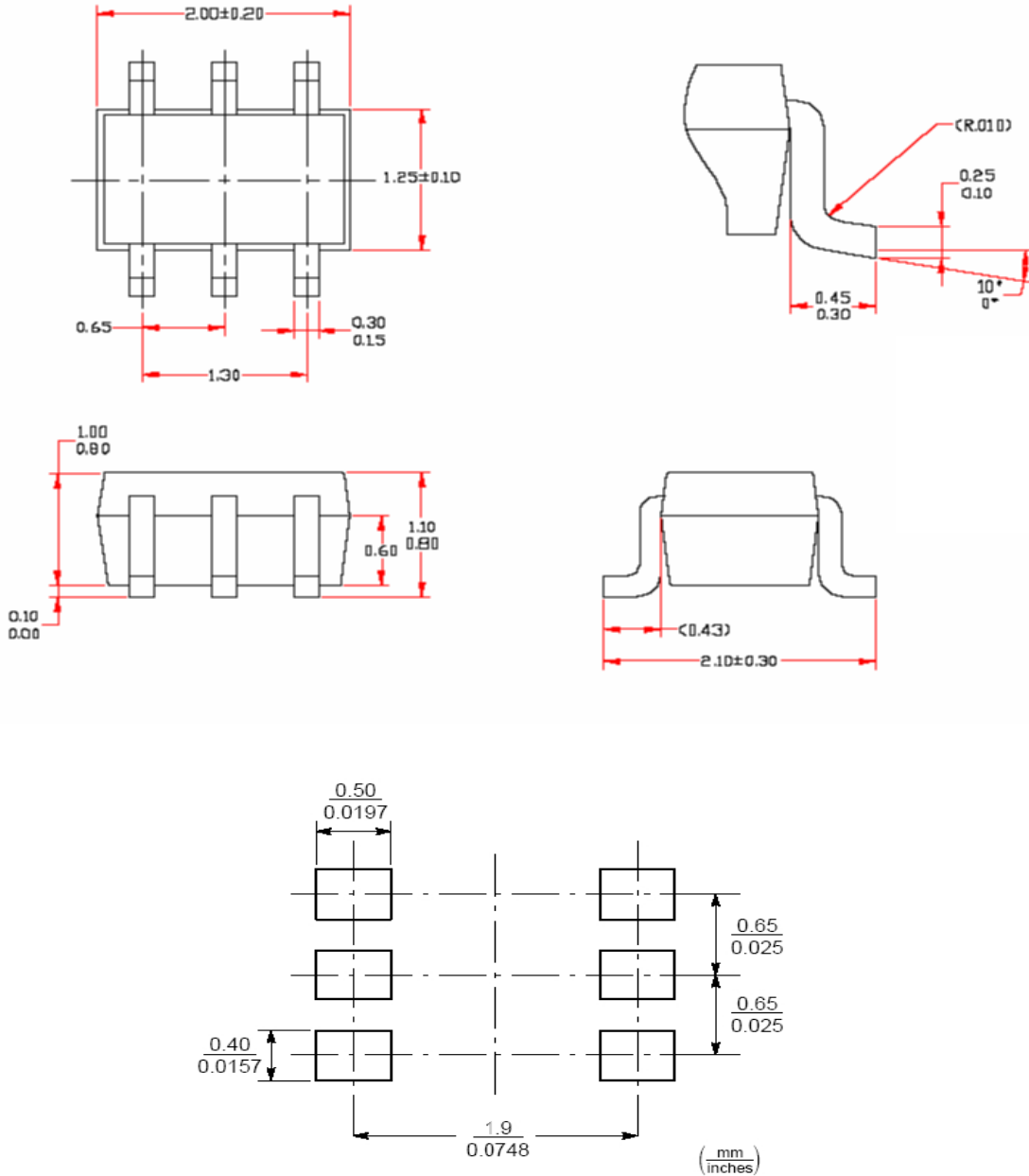

Fig. 6. Source-Drain Diode Forward Voltage



PACKAGE LAYOUT AND SUGGESTED PAD DIMENSIONS



ORDERING INFORMATION

BSS84DW T/R7 - 7 inch reel, 3K units per reel

BSS84DW T/R13 - 13 inch reel, 10K units per reel

Copyright PanJit International, Inc 2005

The information presented in this document is believed to be accurate and reliable. The specifications and information herein are subject to change without notice. Pan Jit makes no warranty, representation or guarantee regarding the suitability of its products for any particular purpose. Pan Jit products are not authorized for use in life support devices or systems. Pan Jit does not convey any license under its patent rights or rights of others.