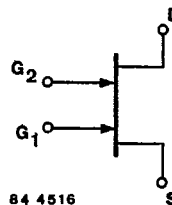
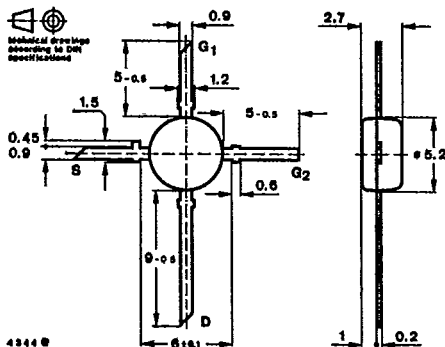

N-Channel-GaAs-MESFET-Tetrode Depletion Mode

Applications: Gain controlled amplifiers and mixers up to 2 GHz in common source configuration;
In wireless telephone, broadcast sets, cable TV and equipments with low power supply.

Features:

- Low noise figure
- High gain
- Low input capacitance
- High AGC-range
- Large input signal behaviour
- Near constant characteristics in frequency range $f = 0.1 \dots 2$ GHz
- Very low cross modulation

Dimensions in mm

Case
50B4DIN41867
JEDEC TO 50
Weight max. 0.1 g

Absolute maximum ratings

Drain Source voltage	V_{DS}	10	V
Drain current	I_D	80	mA
Gate 1/Gate 2-peak current	I_G	1	mA
Gate1/Gate 2-Source voltage	V_{GS}	6	V
Total power dissipation $T_{amb} \leq$ see page A 24, Fig. 6.3	P_{tot}	200	mW
Channel temperature	T_C	125	°C
Storage temperature range	T_{stg}	-55...+125	°C

CF 300

T-31-25

DC-Characteristics

$T_{amb} = 25^\circ C$

Drain-Source break down voltage

$I_D = 50 \mu A, V_{G1S} = -6 V, V_{G2S} = 0$

$V_{(BR)DS}$

Min. 10

Max. V

Gate 1-Source cut-off current

$V_{G1S} = -6 V, V_{DS} = V_{G2S} = 0$

I_{G1SS}

Typ. 20

Max. μA

Gate 2-Source cut-off current

$V_{G2S} = -6 V, V_{DS} = V_{G1S} = 0$

I_{G2SS}

Typ. 20

Max. μA

Gate 1-Source cut-off voltage

$V_{DS} = 5 V, V_{G2S} = 0, I_D = 200 \mu A$

$-V_{G1S(p)}$

Typ. 3

Max. V

Gate 2-Source cut-off voltage

$V_{DS} = 5 V, V_{G1S} = 0, I_D = 200 \mu A$

$-V_{G2S(p)}$

Typ. 3

Max. V

Drain current

$V_{DS} = 5 V, V_{G1S} = V_{G2S} = 0$

$I_{DSS}^{1)}$

Min. 10

Typ. 40

Max. 80

mA

AC-Characteristics

$V_{DS} = 5 V, V_{G2S} = 2 V, I_D = 10 mA, T_{amb} = 25^\circ C$

Forward transfer admittance

$f = 1 MHz$

$|y_{21}|$

Typ. 25

Max. mS

Gate 1-Source capacitance

$f = 1 MHz$

C_{11}

Typ. 0.9

Max. 1.2

pF

Drain-Source capacitance

$f = 1 MHz$

C_{22}

Typ. 0.6

Max. 0.9

pF

Power gain

$f = 800 MHz$

G_{max}

Typ. 23

Max. dB

AGC range

$V_{G2S} = +2 \dots -6 V, f = 800 MHz$

ΔG

Typ. 50

Max. dB

Noise figure

$f = 800 MHz$

F

Typ. 1.1

Max. dB

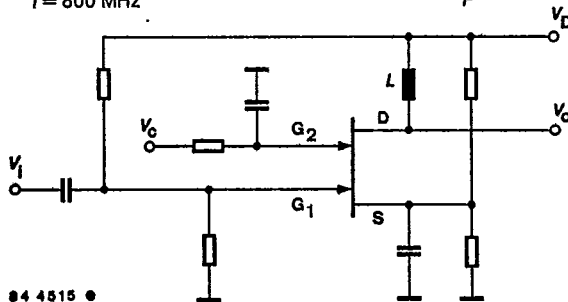

$V_c = \text{control voltage}$

• 4 4515 •

Typical application

¹⁾ Available in I_{DSS} -groups on request

A: 10-35 mA, B: 30-50 mA, C: 45-80 mA

T-31-25 CF 300

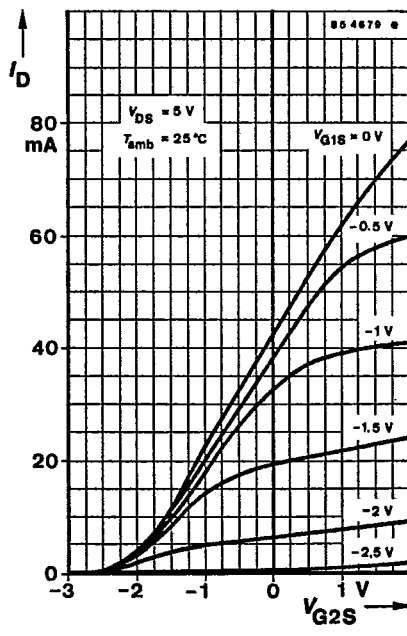
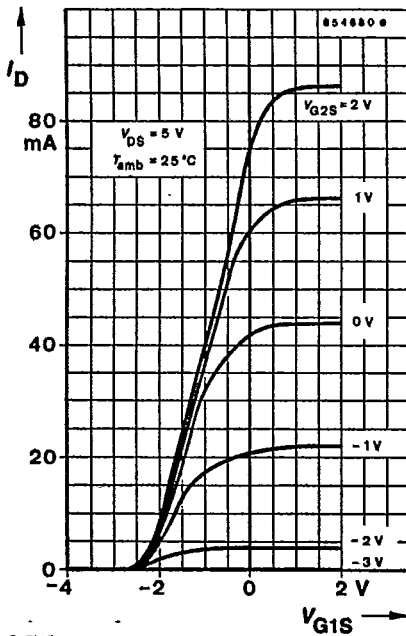
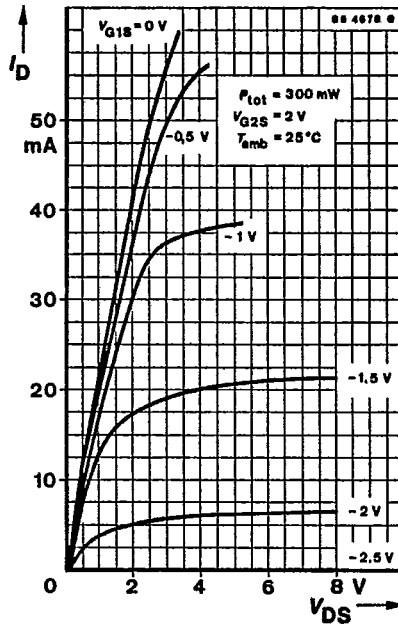
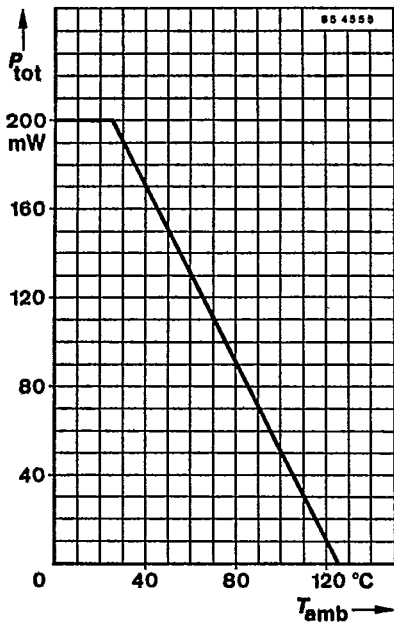

3654 B-09

CF 300

T-31-25

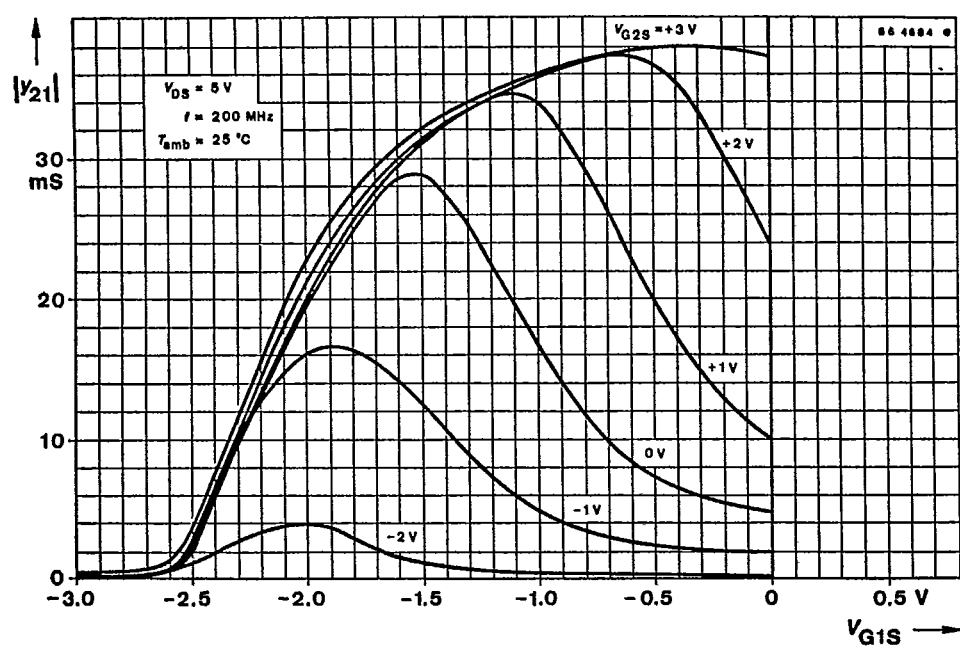
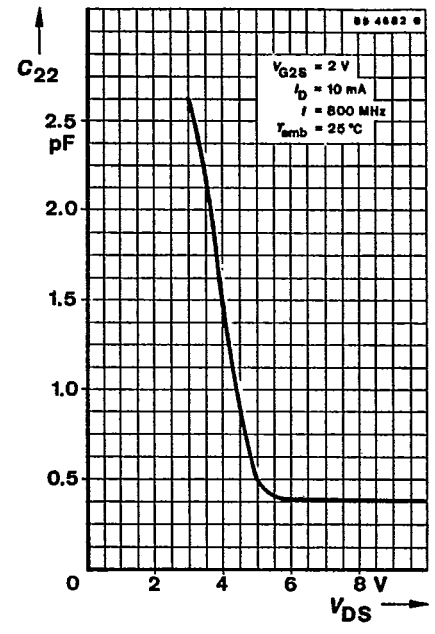
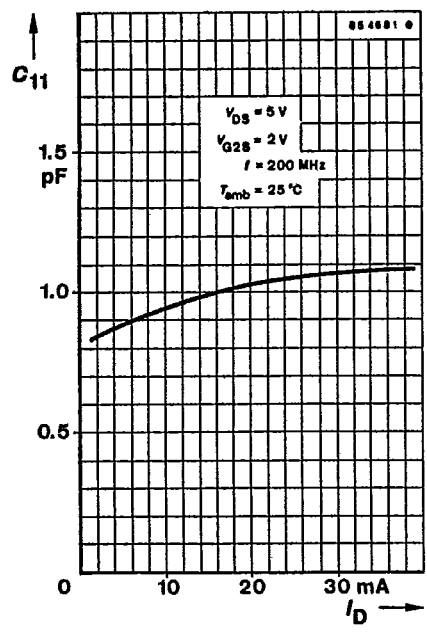

T-31-25 CF 300

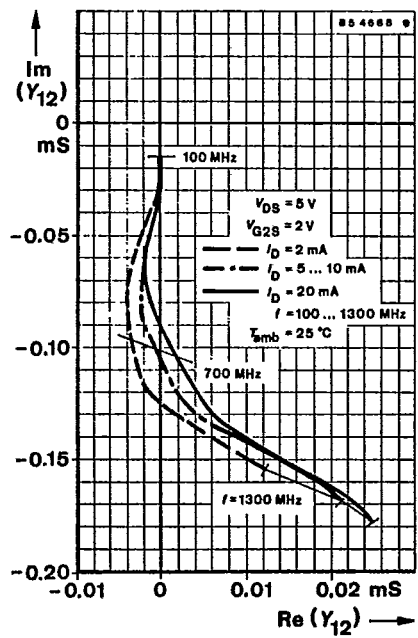
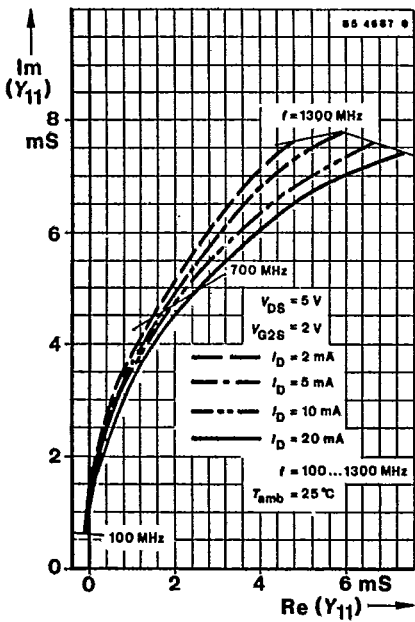
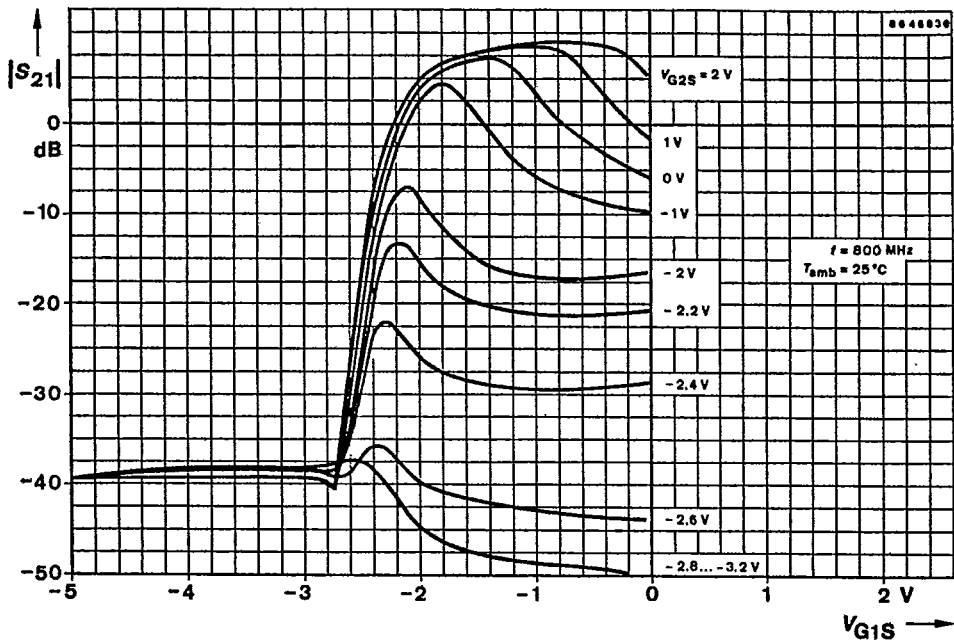

CF 300

7-31-25

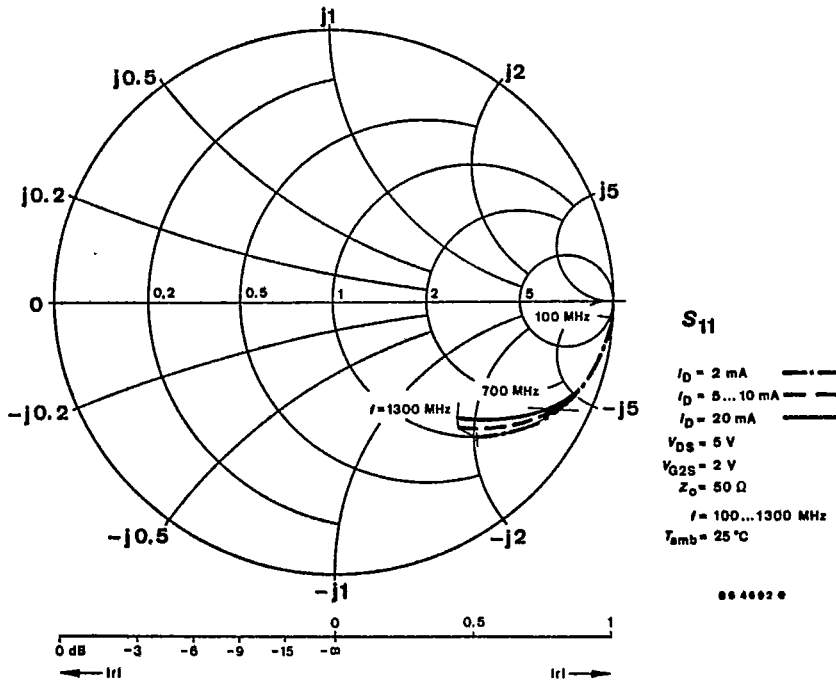
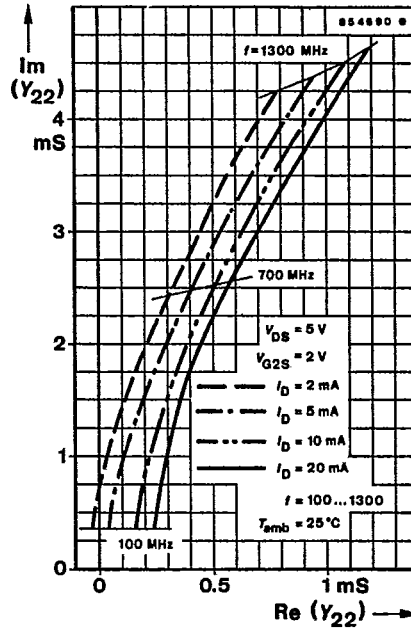
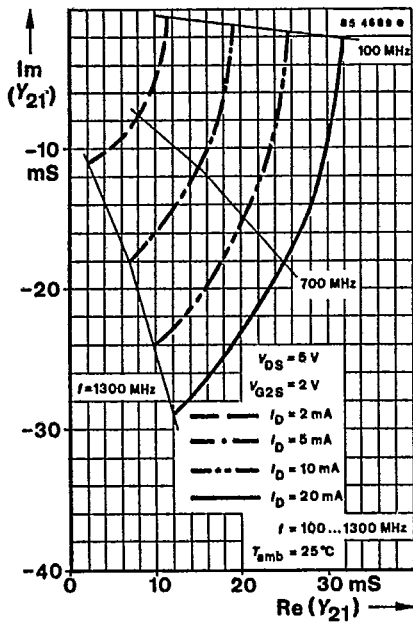

T-31-25

CF 300

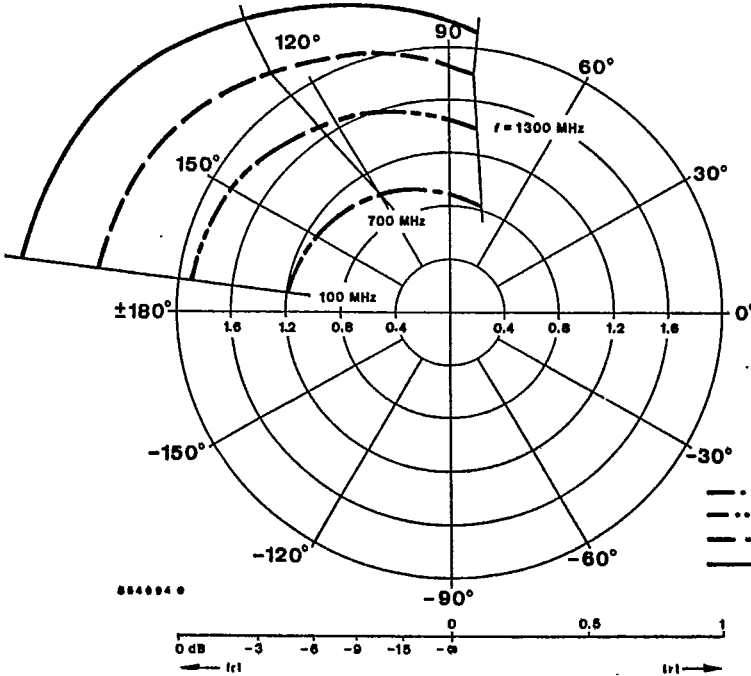
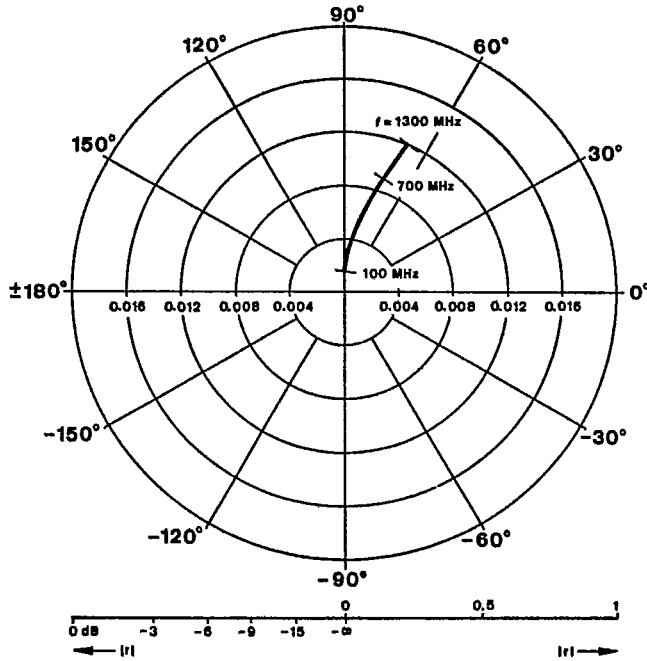

CF 300

T-31-25

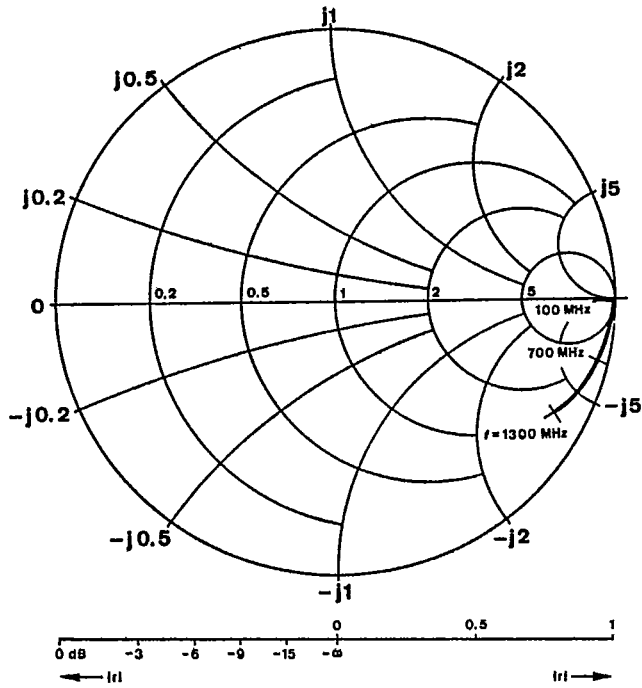

S_{22}

$I_D = 2 \dots 20 \text{ mA}$
 $V_{DS} = 5 \text{ V}$
 $V_{G2S} = 2 \text{ V}$
 $Z_0 = 50 \Omega$
 $f = 100 \dots 1300 \text{ MHz}$
 $T_{amb} = 25 \text{ }^\circ\text{C}$

88 4696 6

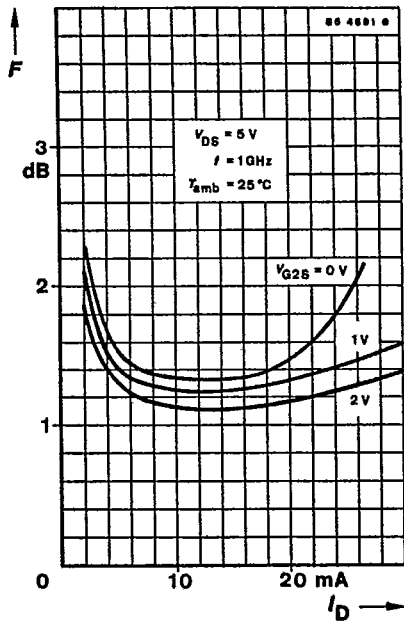

7. Taping and Reeling

T-91-20

7.1. Taping of TO-92 Transistors

Standard reeling: Taped on reel, reeled together with a paper film.

7.1.1. Order Numbers

Add the taping-code to the order number.

Example:

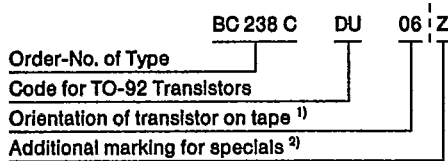

- ¹⁾ 06 = View on flat side of transistor, view on gummed tape
- 05 = View on round side of transistor, view on gummed tape
- ²⁾ Additional marking "0": taping without paper film
- Additional marking "Z": Zigzag folded tape in special box. Marking for orientation of transistor not necessary, because box can be opened on top or bottom

Example for order No.: BC 237 C DU Z

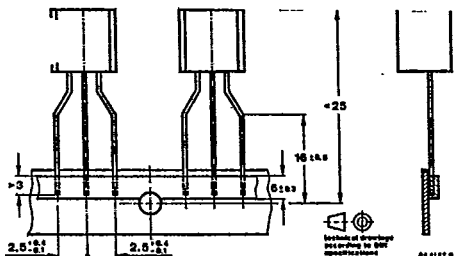

Fig. 7.3 Dimensions of tape in mm

7.1.2 Quantity of devices

- 1 000 devices per reel
- 2 000 devices per folded tape in special box.

7.2. Taped transistors in SOT 23 and SOT 143 case

7.2.1. Designation

a) Standard taping

Designation is attached with code GS 08 in case of standard taping. Example for normal version transistors as standard taped: BF 569-GS 08.

Example for R-version transistors as standard taped: BF 569 R-GS 08.

In case of standard taping, the transistor orientation on the tape is shown in Fig. 7.4 and Fig. 7.5.

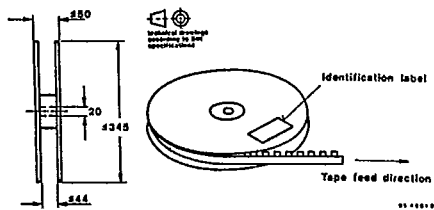

Fig. 7.1. Dimensions of reel in mm

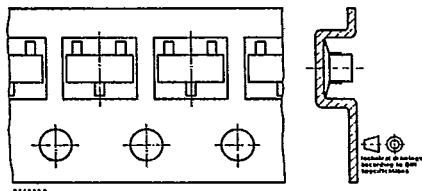

Fig. 7.4 Standard taped SOT 23

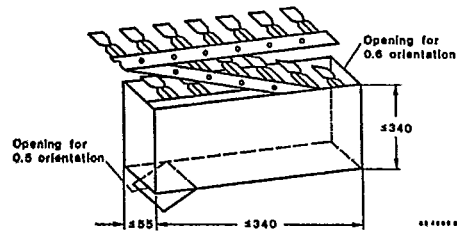

Fig. 7.2. Dimension of box for Zigzag folding in mm

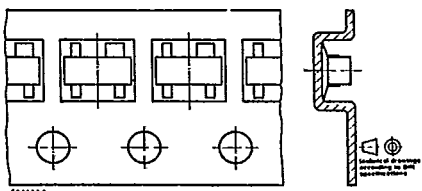

Fig. 7.5. Standard taped SOT 143

T-91-20

b) Reverse taping

Designation is attached with code GS07 in case of reverse taping. Example for normal version transistors as reverse taped: BF 569-GS 07.

Example for R-version transistors as reverse taping: BF 569 R-GS 07.

In case of reverse taping, the transistor orientation on the tape is shown in Fig. 7.6.

Regarding MOS-FET and MES-FET devices, reverse taping is at present not available.

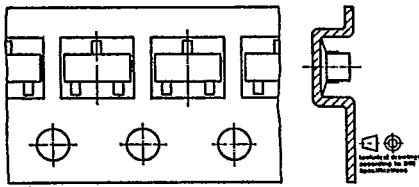

Fig. 7.6 Reverse taped SOT 23

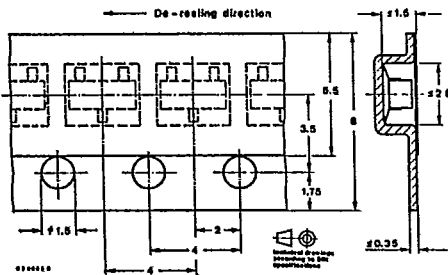

Fig. 7.7 Dimensions of tape in mm

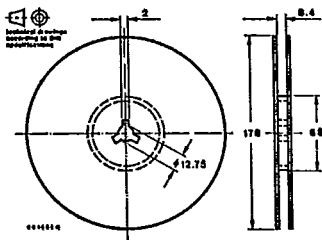

Fig. 7.8 Dimensions of reel in mm

7.2.2 Quantity of devices

3000 devices per reel