

PLEASE CHECK WWW.MOLEX.COM FOR LATEST PART INFORMATION

Part Number: **0740602501**
Status: **Active**
Overview: vhdm
Description: 2.00mm (.079") Pitch VHDM® Board-to-Board Backplane Header, Vertical, 8-Row, Open Signal Module, 200 Circuits, Pin Length 4.75mm (.187")

Documents:

[3D Model](#) [Product Specification PS-74031-999 \(PDF\)](#)
[Drawing \(PDF\)](#) [RoHS Certificate of Compliance \(PDF\)](#)

General

Product Family	Backplane Connectors
Series	<u>74060</u>
Application	Backplane
Application Tooling Documents	Tooling Manual
Comments	Open Header
Component Type	PCB Header
Overview	<u>vhdm</u>
Product Name	VHDM®
Style	N/A

Physical

Circuits (Loaded)	200
Circuits (maximum)	200
Color - Resin	Black
Durability (mating cycles max)	200
First Mate / Last Break	No
Guide to Mating Part	No
Keying to Mating Part	None
Material - Metal	Beryllium Copper, High Performance Alloy (HPA)
Material - Plating Mating	Gold
Material - Plating Termination	Tin-Lead
Material - Resin	High Temperature Thermoplastic
Number of Columns	N/A
Number of Pairs	Open Pin Field
Number of Rows	8
Orientation	Vertical
PC Tail Length (in)	0.098 In
PC Tail Length (mm)	2.50 mm
PCB Locator	No
PCB Retention	None
PCB Thickness Recommended (in)	0.070 In
PCB Thickness Recommended (mm)	1.80 mm
Packaging Type	Tube
Pitch - Mating Interface (in)	0.079 In
Pitch - Mating Interface (mm)	2.00 mm
Pitch - Term. Interface (in)	0.039 In
Pitch - Term. Interface (mm)	1.00 mm
Plating min: Mating (µin)	30
Plating min: Mating (µm)	0.75
Plating min: Termination (µin)	30
Plating min: Termination (µm)	0.75
Polarized to PCB	Yes
Stackable	Yes
Surface Mount Compatible (SMC)	Yes

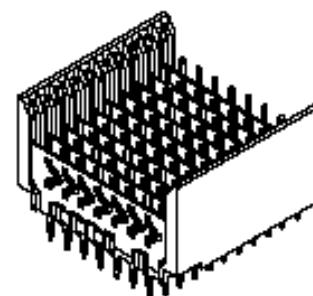

image - Reference only

Series

EU RoHS

RoHS Compliant by Exemption

REACH SVHC

Contains SVHC: No

Halogen-Free

Status

Halogen-Free

China RoHS



Pb

Need more information on product environmental compliance?

Email productcompliance@molex.com
 For a multiple part number RoHS Certificate of Compliance, [click here](#)

Please visit the [Contact Us](#) section for any non-product compliance questions.

Search Parts in this Series

[74060Series](#)

Mates With

[74040 VHDM® Board-to-Board Daughtercard Receptacle](#)

Application Tooling | FAQ

Tooling specifications and manuals are found by selecting the products below. Crimp Height Specifications are then contained in the Application Tooling Specification document.

Global

Description	Product #
Flat Rock Tooling for Pneumatic Press	0622013700
VHDM® Signal Pin	0622015700
Insert Repair Tool	
VHDM® 8 Row Pin and Shield Repair Tool	0622015900

Temperature Range - Operating -55°C to +105°C
Termination Interface: Style Through Hole - Compliant Pin

Electrical

Current - Maximum per Contact 3A
Data Rate 3.125 Gbps
Real Signals (per 25mm) 100
Shield Type Ground Plane Shield
Shielded Yes
Voltage - Maximum 120V AC (RMS)/DC

Material Info

Reference - Drawing Numbers

Packaging Specification PK-74060-003
Product Specification PS-74031-999
Sales Drawing SD-74060-002

VHDM and Very High Density Metric are trademarks of Amphenol Corporation

VHDM® 8 Row Shield Extraction Tool [0622016100](#)
VHDM® Insertion Module for Advanced Mate Signal Header, 6 Row by 25 Wide, 50.00mm (1.97") [0622020206](#)
VHDM® Insertion Module for Standard Shield Signal Header, 8 Row by 25 Wide, 50.00mm (1.97") [0622020210](#)

This document was generated on 05/19/2010

PLEASE CHECK WWW.MOLEX.COM FOR LATEST PART INFORMATION

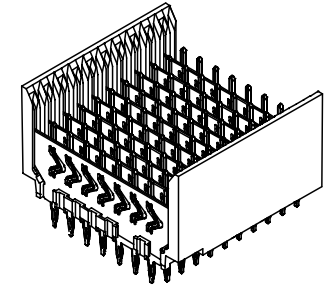
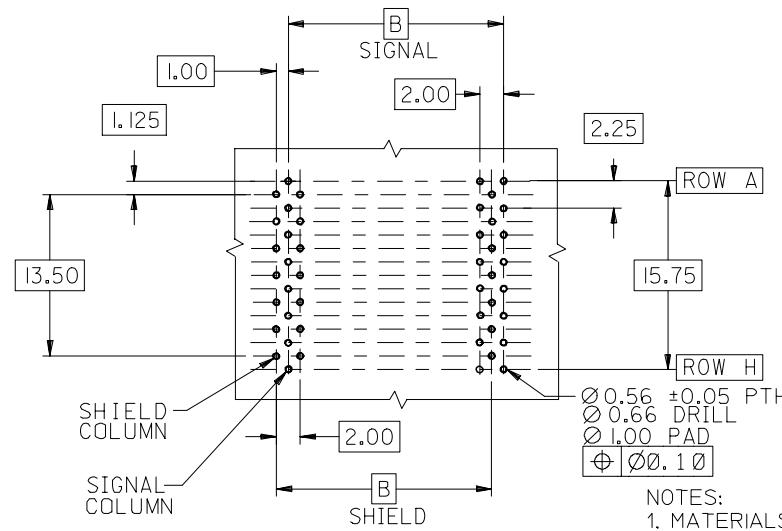
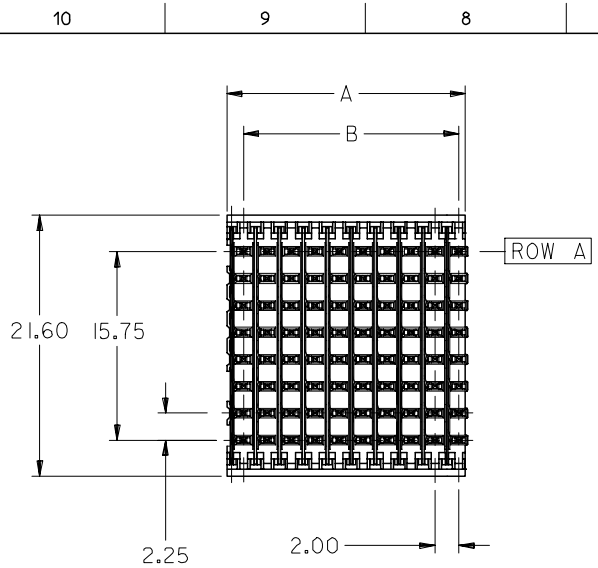

**BACKPLANE HOLE PATTERN
RECOMMENDED DIMENSION**

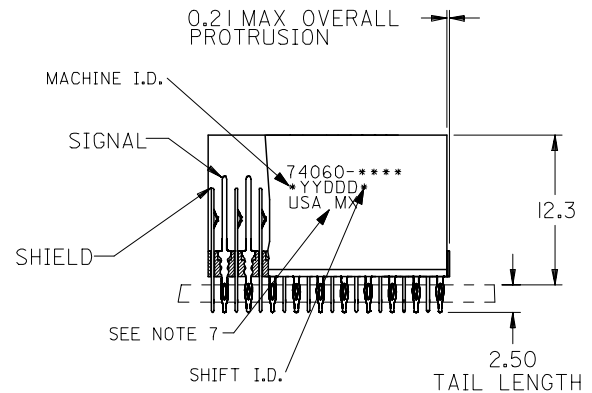
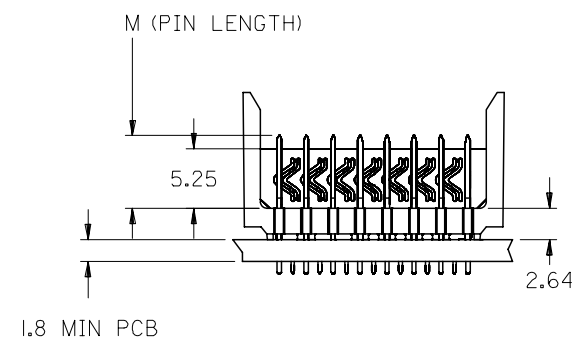

- NOTES:
- MATERIALS:
HOUSING - LIQUID CRYSTAL POLYMER (LCP),
GLASS-FILLED, UL 94V-0, COLOR: BLACK
SIGNAL PIN & SHIELD - COPPER ALLOY
 - FINISHES:
CONTACT AREA: SELECTIVE GOLD (Au)
PCB TAILS: SELECTIVE TIN/LEAD (Sn/Pb)
OR SELECTIVE MATTE TIN (Sn)
NICKEL (Ni) OVERALL.
 - THIS PART CONFORMS TO MOLEX PRODUCT SPECIFICATION PS-74031-999
 - FOR MIXED CONTACT LENGTHS CONSULT MOLEX FOR AVAILABILITY
 - FOR SPECIFIC MATERIAL NUMBERS & MATING INFORMATION REFER TO SHEET 2
 - PACKAGE PER PK-74060-003
 - EITHER MARK PART WITH PART NUMBER & DATE CODE APPROXIMATELY WHERE SHOWN OR PLACE LABEL ON THE TUBE.

ADD LEADFREE PINS EC NO: UCP2006-0079 DRWN: KMULVEY 2005/07/20 CHKD: 2005/07/21 APPR: SREED 2005/07/22	QUALITY SYMBOLS ▽=0 ▽=0	GENERAL TOLERANCES (UNLESS SPECIFIED)		DIMENSION STYLE	SCALE	DESIGN UNITS	THIRD ANGLE PROJECTION	
		mm	INCH	MM ONLY	2.5:1	METRIC		
		4 PLACES ± ---	± ---	DRAWN BY	DATE	TITLE		
		3 PLACES ± ---	± ---	MWANG	1998/11/09	VHDM 8 ROW OPEN END BACKPLANE SALES ASSEMBLY		
2 PLACES ± ---	± ---	CHECKED BY	DATE	MOLEX INCORPORATED			SHEET NO.	
1 PLACE ± ---	± ---	JLAURX	1998/11/09	MATERIAL NO.			1 OF 2	
ANGULAR ±1/2°		APPROVED BY	DATE	DOCUMENT NO.				
DRAFT WHERE APPLICABLE MUST REMAIN WITHIN DIMENSIONS		CBIXLER	1998/11/09	SEE SHEET 2			SD-74060-002	
THIS DRAWING CONTAINS INFORMATION THAT IS PROPRIETARY TO MOLEX INCORPORATED AND SHOULD NOT BE USED WITHOUT WRITTEN PERMISSION								

10 9 8 7 6 5 4 3 2 1

F
E
D
C
B
A

SIGNAL COLUMN
DAUGHTERCARD CONNECTOR SIDE

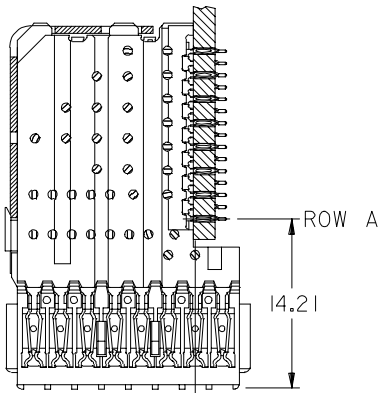
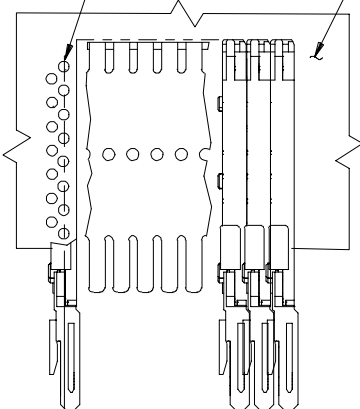

ROW A
14.21

PART NUMBER	COLUMN	NUMBER OF SIGNAL PIN	NUMBER OF SHIELD	A	B	M	Au (um) THICKNESS	Sn (um) THICKNESS
74060-*001	10	80	10	20.00	18.00	4.75	0.76	0.76-1.52
74060-*006							1.27	
74060-*501	25	200	25	50.00	48.00	6.25	0.76	
74060-*506							1.27	
74060-*002	10	80	10	20.00	18.00	4.25	0.76	
74060-*007							1.27	
74060-*502	25	200	25	50.00	48.00	5.15	0.76	
74060-*507							1.27	
74060-*003	10	80	10	20.00	18.00	4.25	0.76	
74060-*008							1.27	
74060-*503	25	200	25	50.00	48.00	5.15	0.76	
74060-*508							1.27	
74060-*004	10	80	10	20.00	18.00	4.25	0.76	
74060-*009							1.27	
74060-*504	25	200	25	50.00	48.00	5.15	0.76	
74060-*509							1.27	

0.41 OFFSET SIGNAL TO SIGNAL

TOP OF DAUGHTERCARD PCB TO ϕ OF ROW A

2.45

SHIELD
SIGNAL

ROW A

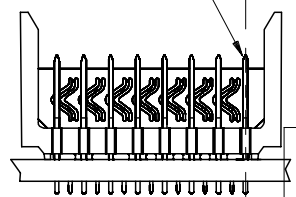
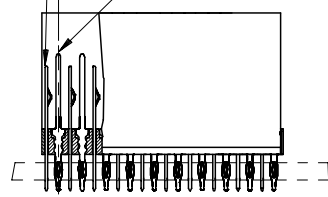

MATERIAL NUMBER ASSIGNMENT

74060-*** **

SEE TABLE

NUMBER OF COLUMNS/PLATING
 10 = 10 COLUMN TIN/LEAD
 25 = 25 COLUMN TIN/LEAD
 90 = 10 COLUMN MATTE TIN
 85 = 25 COLUMN MATTE TIN

SEE SHEET 1
 EC NO: UCP2006-0079
 DRWNG: MULLVEY 2005/07/20
 CHKD: 2005/07/21
 APPR: SREED 2005/07/22

QUALITY SYMBOLS

	GENERAL TOLERANCES (UNLESS SPECIFIED)	
	mm	INCH
4 PLACES	± ---	± ---
3 PLACES	± ---	± ---
2 PLACES	± ---	± ---
1 PLACE	± ---	± ---
ANGULAR ±1/2°		

DIMENSION STYLE	
MM ONLY	
DRAWN BY	DATE
MWANG	1998/11/09
CHECKED BY	DATE
JLAURX	1998/11/09
APPROVED BY	DATE
CBIXLER	1998/11/09
MATERIAL NO.	SEE CHART

SCALE	DESIGN UNITS	THIRD ANGLE PROJECTION
2.5:1	METRIC	

TITLE
 VHDM 8 ROW
 OPEN END BACKPLANE
 SALES ASSEMBLY

MOLEX INCORPORATED

DOCUMENT NO. SD-74060-002

SHEET NO. 2 OF 2

9 8 7 6 5 4 3 2 1

THIS DRAWING CONTAINS INFORMATION THAT IS PROPRIETARY TO MOLEX INCORPORATED AND SHOULD NOT BE USED WITHOUT WRITTEN PERMISSION