



Optocoupler, High Reliability, 5300 V_{RMS}

Features

- Low CTR Degradation
- Good CTR Linearity Depending on Forward Current
- Isolation Test Voltage, 5300 V_{RMS}
- High Collector-emitter Voltage, V_{CEO} = 70 V
- Low Saturation Voltage
- Fast Switching Times
- Temperature Stable
- Low Coupling Capacitance
- End-Stackable, .100 " (2.54 mm) Spacing
- High Common-mode Interference Immunity (Unconnected Base)
- Lead-free component
- Component in accordance to RoHS 2002/95/EC and WEEE 2002/96/EC

Agency Approvals

- UL1577, File No. E52744 System Code H or J, Double Protection
- DIN EN 60747-5-2 (VDE0884)
DIN EN 60747-5-5 pending
Available with Option 1

Description

The SFH615XXX features a large assortment of current transfer ratio, low coupling capacitance and high isolation voltage. These couplers have a GaAs infrared emitting diode emitter, which is optically coupled to a silicon planar phototransistor detector, and is incorporated in a plastic DIP-4 package.

The coupling devices are designed for signal transmission between two electrically separated circuits.

The couplers are end-stackable with 2.54 mm lead spacing.

Creepage and clearance distances of > 8 mm are achieved with option 6. This version complies with 60950 (DIN VDE 0805) for reinforced insulation up to operation voltage of 400 V_{RMS} or DC.

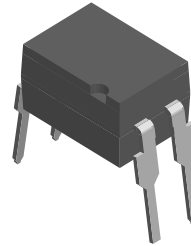

i179060

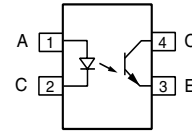

Order Information

Part	Remarks
SFH615AA	CTR 50 - 600 %, DIP-4
SFH615AB	CTR 80 - 260 %, DIP-4
SFH615ABL	CTR 200 - 600 %, DIP-4
SFH615ABM	CTR 200 - 400 %, DIP-4
SFH615AGB	CTR 100 - 600 %, DIP-4
SFH615AGR	CTR 100 - 300 %, DIP-4
SFH615AY	CTR 50 - 150 %, DIP-4
SFH615AA-X006	CTR 50 - 600 %, DIP-4 400 mil (option 6)
SFH615AA-X007	CTR 50 - 600 %, SMD-4 (option 7)
SFH615ABM-X006	CTR 200 - 400 %, DIP-4 400 mil (option 6)
SFH615ABM-X007	CTR 200 - 400 %, SMD-4 (option 7)
SFH615AGB-X006	CTR 100 - 600 %, DIP-4 400 mil (option 6)
SFH615AGB-X009	CTR 100 - 600 %, SMD-4 (option 9)
SFH615AGR-X006	CTR 100 - 300 %, DIP-4 400 mil (option 6)
SFH615AGR-X007	CTR 100 - 300 %, SMD-4 (option 7)
SFH615AY-X006	CTR 50 - 150 %, DIP-4 400 mil (option 6)
SFH615AY-X008	CTR 50 - 150 %, SMD-4 (option 8)
SFH615AY-X009	CTR 50 - 150 %, SMD-4 (option 9)

For additional information on the available options refer to Option Information.

Absolute Maximum Ratings

$T_{amb} = 25\text{ }^{\circ}\text{C}$, unless otherwise specified

Stresses in excess of the absolute Maximum Ratings can cause permanent damage to the device. Functional operation of the device is not implied at these or any other conditions in excess of those given in the operational sections of this document. Exposure to absolute Maximum Rating for extended periods of the time can adversely affect reliability.

Input

Parameter	Test condition	Symbol	Value	Unit
Reverse voltage		V_R	6.0	V
DC Forward current		I_F	60	mA
Surge forward current	$t_p \leq 1.0\text{ ms}$	I_{FSM}	2.5	A
Power dissipation		P_{diss}	100	mW

Output

Parameter	Test condition	Symbol	Value	Unit
Collector-emitter voltage		V_{EC}	70	V
Emitter-collector voltage		V_{CE}	7.0	V
Collector current		I_C	50	mA
	$t_p \leq 1.0\text{ ms}$	I_C	100	mA
Total power dissipation		P_{diss}	150	mW

Coupler

Parameter	Test condition	Symbol	Value	Unit
Isolation test voltage between emitter and detector, refer to climate DIN 40046 part 2, Nov.74		V_{ISO}	5300	V_{RMS}
Creepage			≥ 7.0	mm
Clearance			≥ 7.0	mm
Insulation thickness between emitter and detector comparative tracking index per DIN IEC 112/VDEO 303, part 1			≥ 175	
Isolation resistance	$V_{IO} = 500\text{ V}, T_{amb} = 25\text{ }^{\circ}\text{C}$	R_{IO}	$\geq 10^{12}$	Ω
	$V_{IO} = 500\text{ V}, T_{amb} = 100\text{ }^{\circ}\text{C}$	R_{IO}	$\geq 10^{11}$	Ω
Storage temperature range		T_{stg}	- 55 to + 150	$^{\circ}\text{C}$
Ambient temperature range		T_{amb}	- 55 to + 100	$^{\circ}\text{C}$
Junction temperature		T_J	100	$^{\circ}\text{C}$
Soldering temperature	max. 10 s. dip soldering distance to seating plane $\geq 1.5\text{ mm}$	T_{sld}	260	$^{\circ}\text{C}$



Electrical Characteristics

T_{amb} = 25 °C, unless otherwise specified

Minimum and maximum values are testing requirements. Typical values are characteristics of the device and are the result of engineering evaluation. Typical values are for information only and are not part of the testing requirements.

Input

Parameter	Test condition	Symbol	Min	Typ.	Max	Unit
Forward voltage	I _F = 60 mA	V _F		1.25	1.65	V
Reverse current	V _R = 6.0 V	I _R		0.01	10	μA
Capacitance	V _R = 0 V, f = 1.0 MHz	C _O		13		pF
Thermal resistance		R _{thja}		750		K/W

Output

Parameter	Test condition	Symbol	Min	Typ.	Max	Unit
Collector-emitter capacitance	V _{CE} = 5 V, f = 1.0 MHz	C _{CE}		5.2		pF
Thermal resistance		R _{thja}		500		K/W

Coupler

Parameter	Test condition	Part	Symbol	Min	Typ.	Max	Unit
Collector-emitter saturation voltage	I _F = 10 mA, I _C = 2.5 mA		V _{CEsat}		0.25	0.4	V
Coupling capacitance			C _C		0.4		pF
Collector-emitter leakage current	V _{CEO} = 10 V	SFH615AA	I _{CEO}		10	100	nA
		SFH615AGB	I _{CEO}		10	100	nA
		SFH615AGR	I _{CEO}		10	100	nA
		SFH615ABM	I _{CEO}		10	100	nA
		SFH615ABL	I _{CEO}		10	100	nA
		SFH615AY	I _{CEO}		10	100	nA
		SFH615AB	I _{CEO}		10	100	nA

Current Transfer Ratio

Parameter	Test condition	Part	Symbol	Min	Typ.	Max	Unit
I _C /I _F	I _F = 5.0 mA, V _{CE} = 5.0 V	SFH615AA	CTR	50		600	%
		SFH615AGB	CTR	100		600	%
		SFH615AGR	CTR	100		300	%
		SFH615ABM	CTR	200		400	%
		SFH615ABL	CTR	200		600	%
		SFH615AY	CTR	50		150	%
		SFH615AB	CTR	80		260	%

Switching Characteristics

Parameter	Test condition	Symbol	Min	Typ.	Max	Unit
Turn-on time	$I_F = 5.0 \text{ mA}$	t_{on}		2.0		μs
Turn-off time	$I_F = 5.0 \text{ mA}$	t_{off}		25		μs

Typical Characteristics ($T_{amb} = 25 \text{ }^\circ\text{C}$ unless otherwise specified)

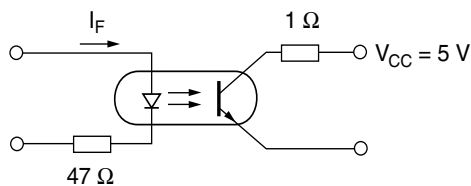

isfh615aa_01

Figure 1. Switching Operation (with Saturation)

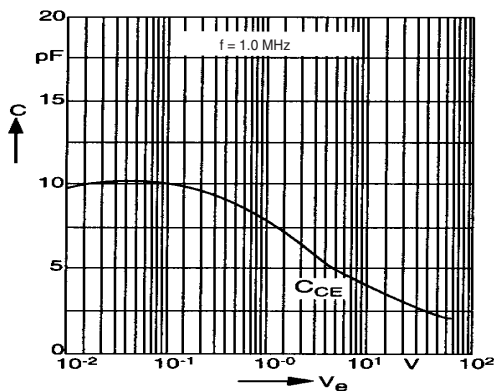

isfh615aa_03

Figure 3. Transistor Capacitance (typ.) vs. Collector-Emitter Voltage

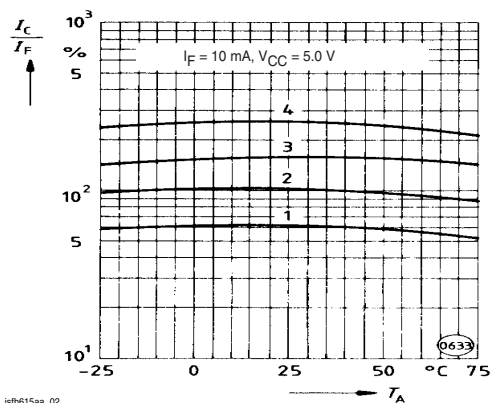

isfh615aa_02

Figure 2. Current Transfer Ratio (typical) vs. Temperature

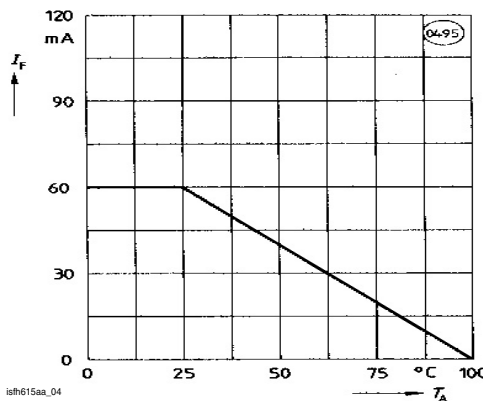

isfh615aa_04

Figure 4. Permissible Diode Forward Current vs. Ambient Temperature

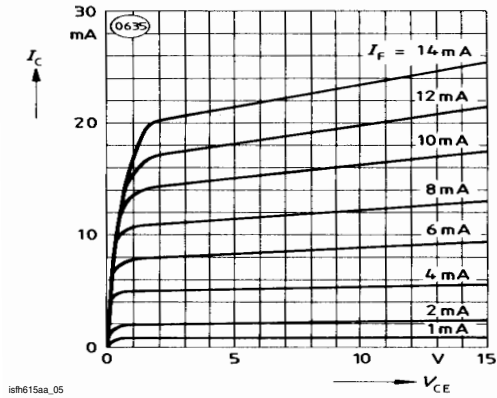

Figure 5. Output Characteristics (typ.) Collector Current vs. Collector-Emitter Voltage

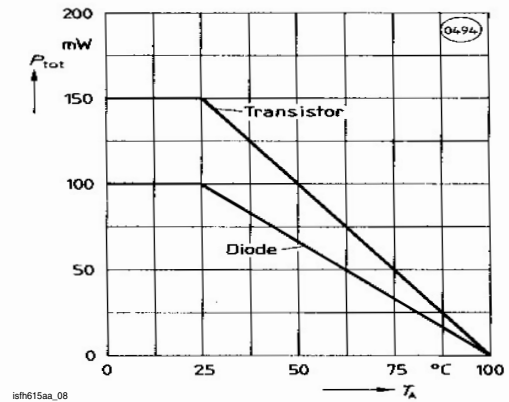

Figure 8. Permissible Power Dissipation vs. Temperature

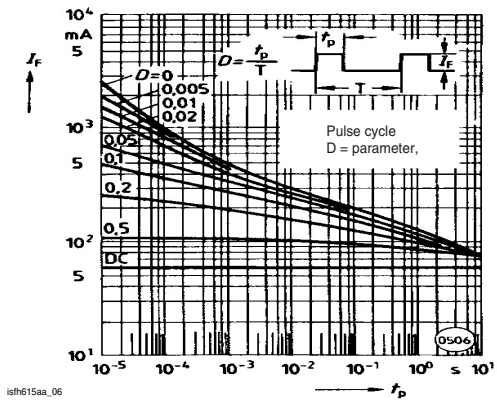

Figure 6. Permissible Pulse Handling Capability Forward Current vs. Pulse Width

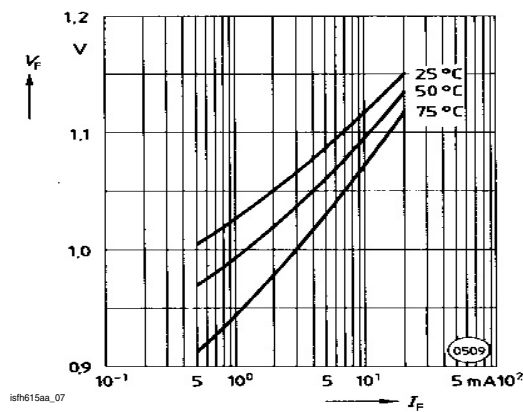

Figure 7. Diode Forward Voltage (typ.) vs. Forward Current

SFH615AA/AGB/AGR/ABM/ABL/AY/AB



Vishay Semiconductors

Package Dimensions in Inches (mm)

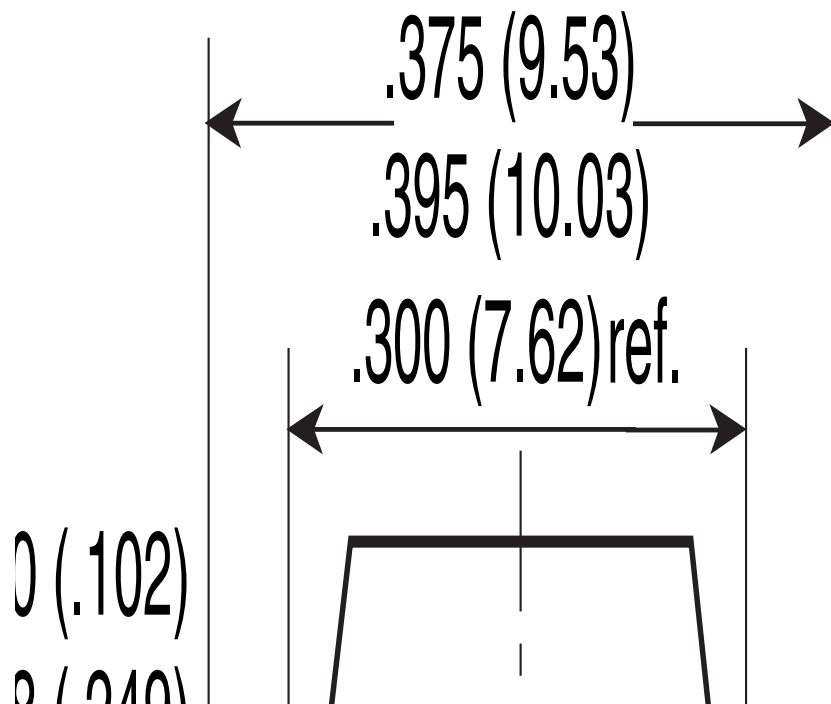
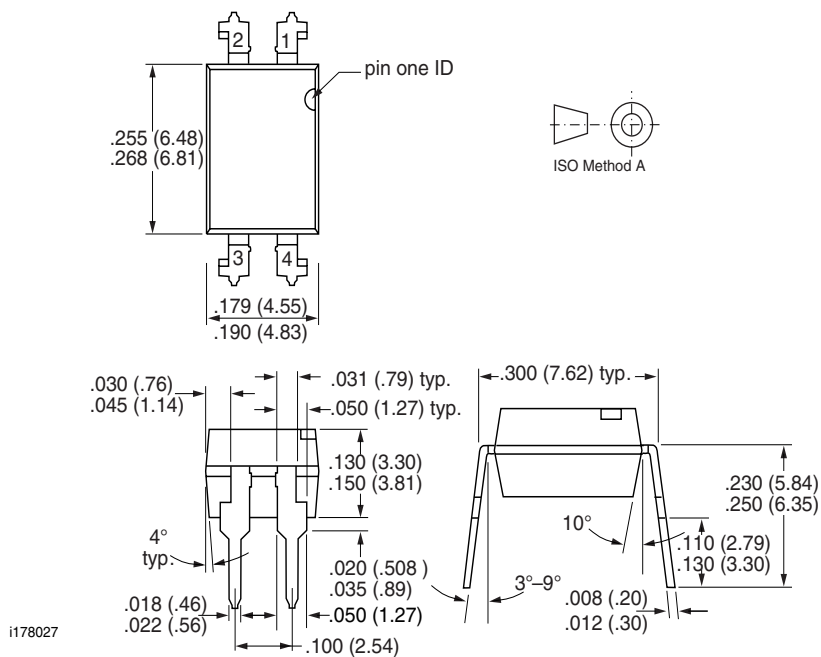



Ozone Depleting Substances Policy Statement

It is the policy of Vishay Semiconductor GmbH to

1. Meet all present and future national and international statutory requirements.
2. Regularly and continuously improve the performance of our products, processes, distribution and operating systems with respect to their impact on the health and safety of our employees and the public, as well as their impact on the environment.

It is particular concern to control or eliminate releases of those substances into the atmosphere which are known as ozone depleting substances (ODSs).

The Montreal Protocol (1987) and its London Amendments (1990) intend to severely restrict the use of ODSs and forbid their use within the next ten years. Various national and international initiatives are pressing for an earlier ban on these substances.

Vishay Semiconductor GmbH has been able to use its policy of continuous improvements to eliminate the use of ODSs listed in the following documents.

1. Annex A, B and list of transitional substances of the Montreal Protocol and the London Amendments respectively
2. Class I and II ozone depleting substances in the Clean Air Act Amendments of 1990 by the Environmental Protection Agency (EPA) in the USA
3. Council Decision 88/540/EEC and 91/690/EEC Annex A, B and C (transitional substances) respectively.

Vishay Semiconductor GmbH can certify that our semiconductors are not manufactured with ozone depleting substances and do not contain such substances.

We reserve the right to make changes to improve technical design and may do so without further notice.

Parameters can vary in different applications. All operating parameters must be validated for each customer application by the customer. Should the buyer use Vishay Semiconductors products for any unintended or unauthorized application, the buyer shall indemnify Vishay Semiconductors against all claims, costs, damages, and expenses, arising out of, directly or indirectly, any claim of personal damage, injury or death associated with such unintended or unauthorized use.

Vishay Semiconductor GmbH, P.O.B. 3535, D-74025 Heilbronn, Germany
Telephone: 49 (0)7131 67 2831, Fax number: 49 (0)7131 67 2423