

# PQ05RF2/21/2V Series

2A Output, Low Power-Loss Voltage Regulators

## Features

- Low power-loss (Dropout voltage: MAX. 0.5V)
- Compact resin full-mold package.
- Built-in ON/OFF control terminal (PQ05RF2/PQ05RF21 series)
- Built-in output voltage minute adjustment terminal (ripple rejection is improved) (PQ05RF2V series)

## Model Line-ups

Output voltage	5V Output	9V Output	12V Output	15V Output
Output voltage precision: ±5%	PQ05RF2	PQ09RF2	PQ12RF2	PQ15RF2
Output voltage precision: ±2.5%	PQ05RF21	PQ09RF21	PQ12RF21	PQ15RF21
Minute adjustment (Output voltage adjustment range: ±10%)	PQ05RF2V	PQ09RF2V	PQ12RF2V	PQ15RF2V

## Applications

- Series power supply for various electronic equipment such as VCRs, electronic music instruments

## Equivalent Circuit Diagram

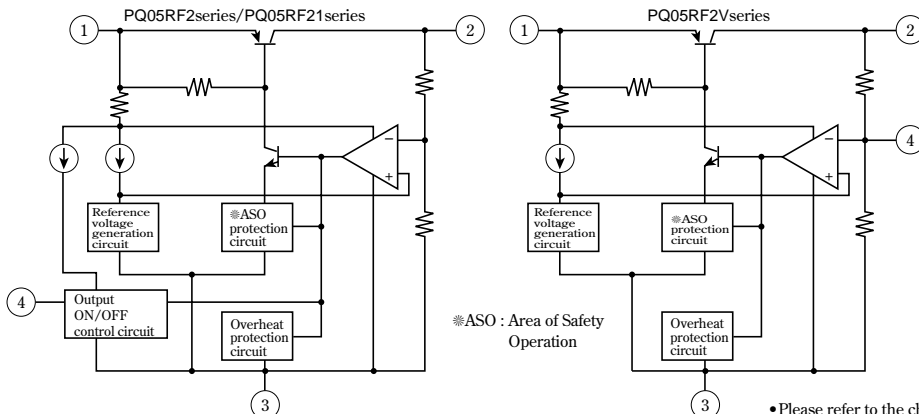

## Outline Dimensions

(Unit : mm)

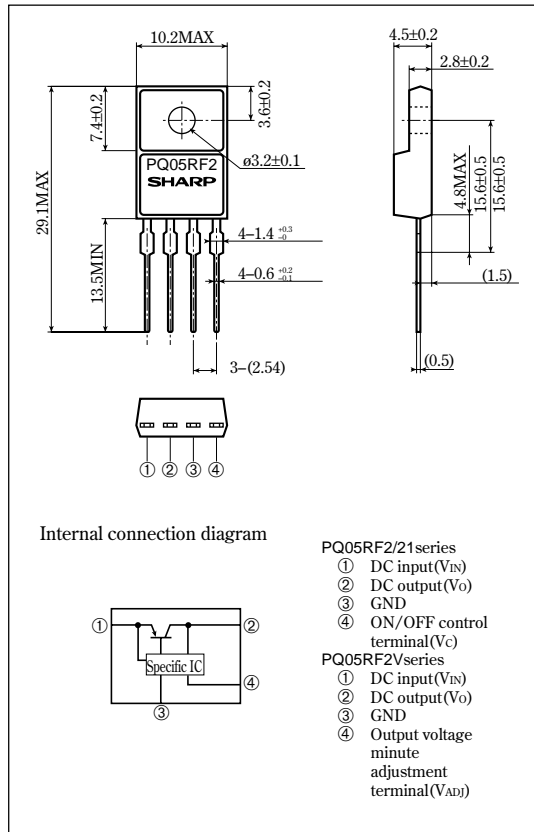

• Please refer to the chapter " Handling Precautions ".

**Absolute Maximum Ratings**

(Ta=25°C)

Parameter	Symbol	Rating	Unit
*1 Input voltage	V <sub>IN</sub>	35	V
*1 ON/OFF control terminal voltage	V <sub>C</sub>	35	V
	PQ05RF21 series		
Output current	I <sub>O</sub>	2	A
Power dissipation(No heat sink)	P <sub>D1</sub>	1.5	W
Power dissipation(With infinite heat sink)	P <sub>D2</sub>	18	W
*2 Junction temperature	T <sub>J</sub>	150	°C
Operating temperature	T <sub>opr</sub>	-20 to +80	°C
Storage temperature	T <sub>stg</sub>	-40 to +150	°C
Soldering temperature	T <sub>sol</sub>	260 (For 10s)	°C

\*1 All are open except GND and applicable terminals.

\*2 Overheat protection may operate at 125<=T<sub>J</sub><=150°C.

**Electrical Characteristics**

(Unless otherwise specified, condition shall be I<sub>O</sub>=1A, Ta=25°C, \*3)

Parameter	Symbol	Conditions	MIN.	TYP.	MAX.	Unit	
Output voltage	V <sub>O</sub>	-	PQ05RF2/PQ05RF2V	4.75	5.0	5.25	V
			PQ09RF2/PQ09RF2V	8.55	9.0	9.45	
			PQ12RF2/PQ12RF2V	11.4	12.0	12.6	
			PQ15RF2/PQ15RF2V	14.25	15.0	15.75	
			PQ05RF21	4.88	5.0	5.12	
			PQ09RF21	8.78	9.0	9.22	
			PQ12RF21	11.7	12.0	12.3	
			PQ15RF21	14.63	15.0	15.37	
Load regulation	R <sub>egL</sub>	I <sub>O</sub> =5mA to 2A	-	0.5	2.0	%	
Line regulation	R <sub>egI</sub>	*4	-	0.5	2.5	%	
Temperature coefficient of output voltage	TcV <sub>O</sub>	T <sub>J</sub> =0 to 125°C	-	±0.02	-	%/°C	
Ripple rejection	RR	I <sub>O</sub> =0.5A Refer to Fig.2	PQ05RF2/PQ05RF21Series	45	55	-	dB
			PQ05RF2VSeries	55	-	-	dB
Dropout voltage	V <sub>i-o</sub>	*5, I <sub>O</sub> =2A	-	-	0.5	V	
ON-state voltage for control	V <sub>C(ON)</sub>	-	2.0 *6	-	-	V	
ON-state current for current	I <sub>C(ON)</sub>	V <sub>C</sub> =2.7V	-	-	20	μA	
OFF-state voltage for control	V <sub>C(OFF)</sub>	-	-	-	0.8	V	
OFF-state current for control	I <sub>C(OFF)</sub>	V <sub>C</sub> =0.4V	-	-	-0.4	mA	
Quiescent current	I <sub>q</sub>	I <sub>O</sub> =0	-	-	10	mA	
Output voltage minute adjustment range	V <sub>O(ADJ)</sub>	-	PQ05RF2V	4.5	5.0	5.5	V
			PQ09RF2V	8.1	9.0	9.9	
			PQ12RF2V	10.8	12.0	13.2	
			PQ15RF2V	13.5	15.0	16.5	

\*3 PQ05RF2 Series: V<sub>IN</sub>=7V, PQ09RF2 Series: V<sub>IN</sub>=15V, PQ12RF2 Series: V<sub>IN</sub>=18V, PQ15RF2 Series: V<sub>IN</sub>=23V

\*4 PQ05RF2/PQ05RF21/PQ05RF2V: V<sub>IN</sub>=6 to 12V PQ09RF2/PQ09RF21/PQ09RF2V: V<sub>IN</sub>=10 to 25V

PQ12RF2/PQ12RF21/PQ12RF2V: V<sub>IN</sub>=13 to 29V PQ15RF2/PQ15RF21/PQ15RF2V: V<sub>IN</sub>=16 to 32V

\*5 Input voltage shall be the value when output voltage is 95% in comparison with the initial value.

\*6 In case of opening control terminal Ⓞ, output voltage turns on. (PQ05RF2/PQ05RF21 Series)

Fig. 1 Test Circuit



Fig. 2 Test Circuit of Ripple Rejection

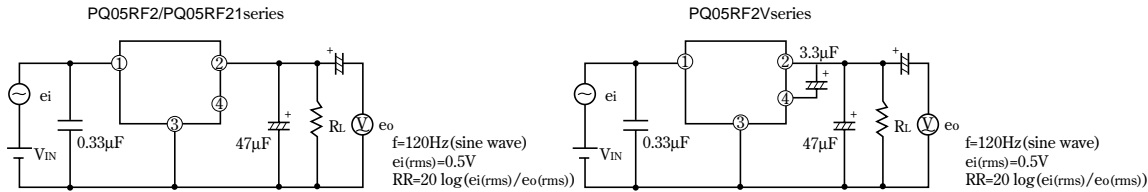
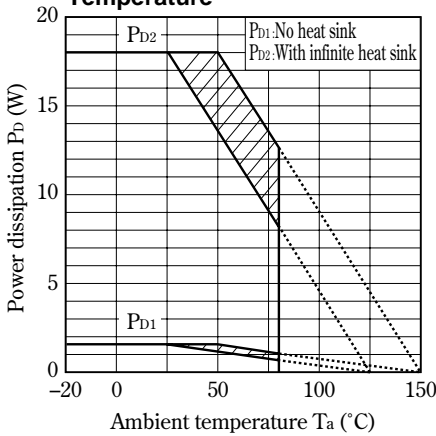

Fig. 3 Power Dissipation vs. Ambient Temperature



Note) Oblique line portion : Overheat protection may operate in this area.

Fig. 4 Overcurrent Protection Characteristics (Typical value)

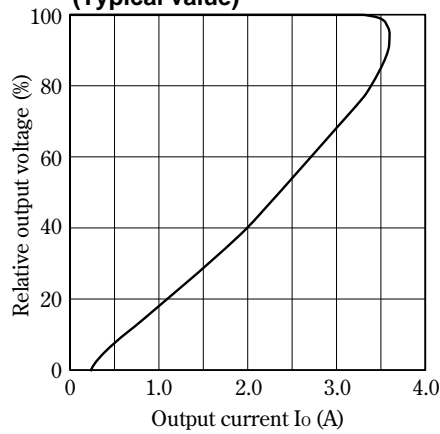

Fig. 5 Output Voltage Minute Adjustment Characteristics (PQ05RF2V)

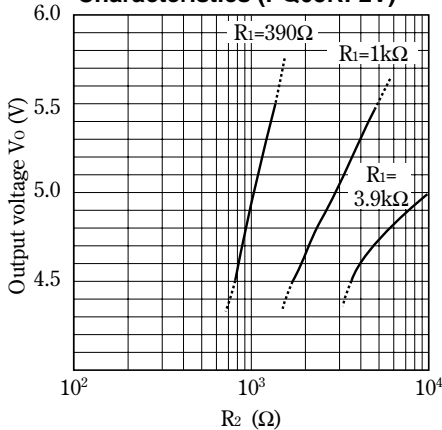
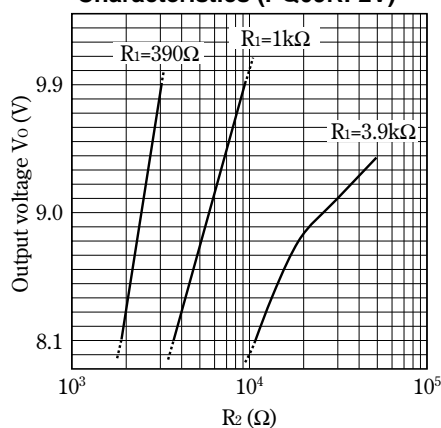
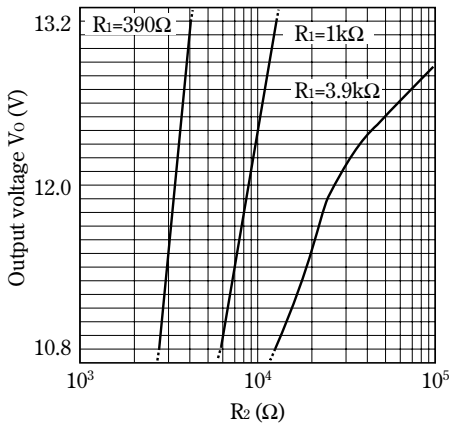

Fig. 6 Output Voltage Minute Adjustment Characteristics (PQ09RF2V)



**Fig. 7 Output Voltage Minute Adjustment Characteristics (PQ12RF2V)**



**Fig. 8 Output Voltage Minute Adjustment Characteristics (PQ15RF2V)**

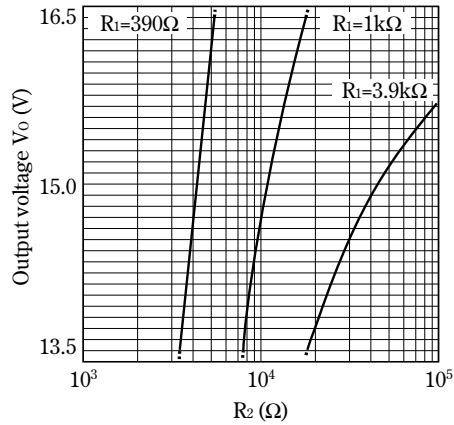

**Fig. 9 Output Voltage Deviation vs. Junction Temperature (PQ05RF2/PQ05RF21/PQ05RF2V)**

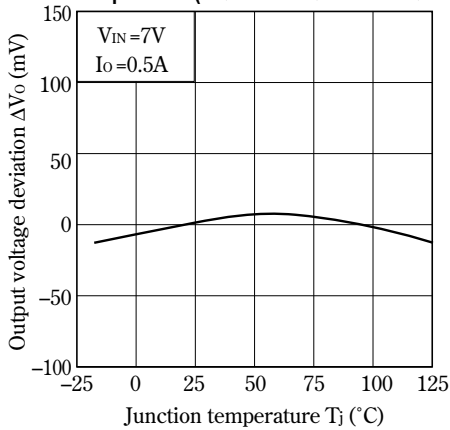

**Fig. 10 Output Voltage Deviation vs. Junction Temperature (PQ09RF2/PQ09RF21/PQ09RF2V)**

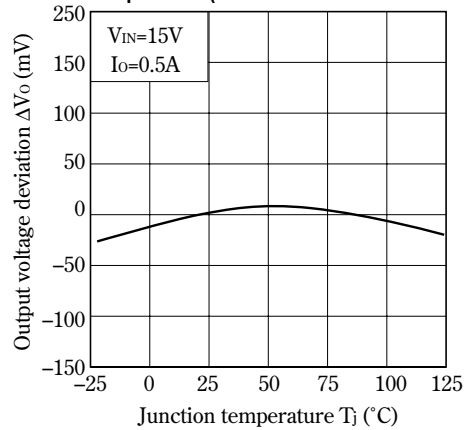

**Fig. 11 Output Voltage Deviation vs. Junction Temperature (PQ12RF2/PQ12RF21/PQ12RF2V)**

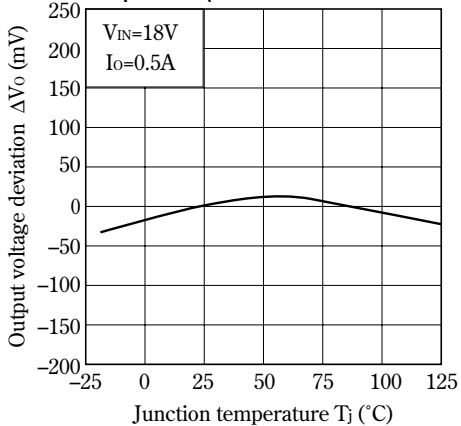

**Fig. 12 Output Voltage Deviation vs. Junction Temperature (PQ15RF2/PQ15RF21/PQ15RF2V)**

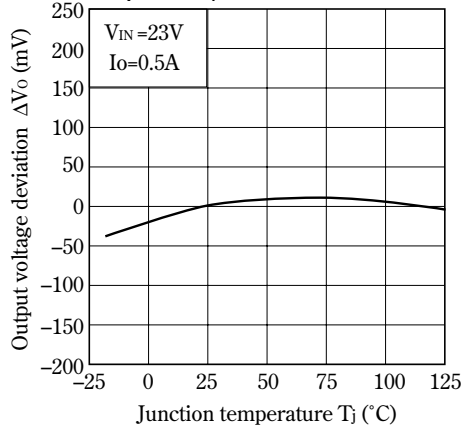

Fig.13 Output Voltage vs. Input Voltage (PQ05RF2/PQ05RF21/PQ05RF2V)

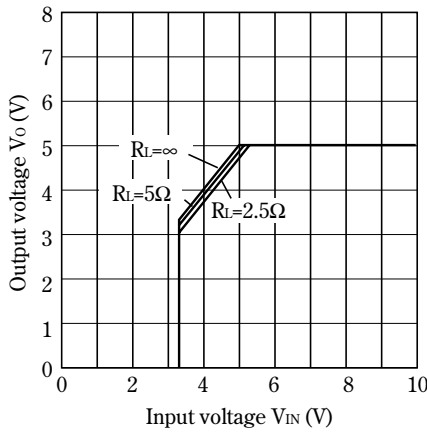

Fig.14 Output Voltage vs. Input Voltage (PQ09RF2/PQ09RF21/PQ09RF2V)

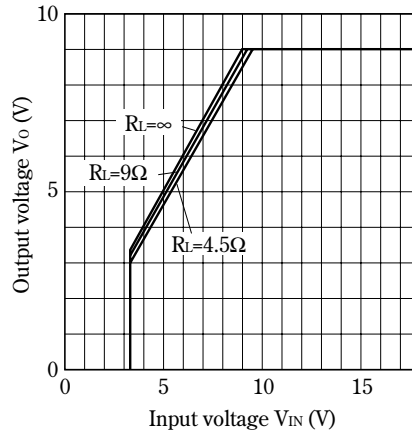

Fig.15 Output Voltage vs. Input Voltage (PQ12RF2/PQ12RF21/PQ12RF2V)

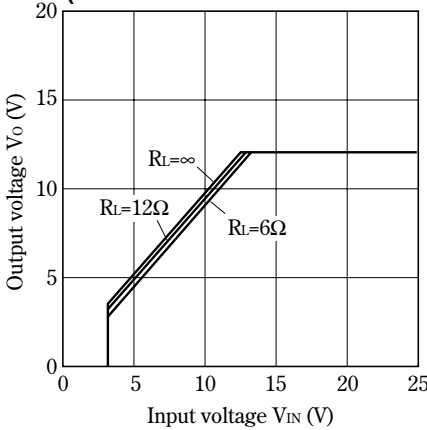

Fig.16 Output Voltage vs. Input Voltage (PQ15RF2/PQ15RF21/PQ15RF2V)

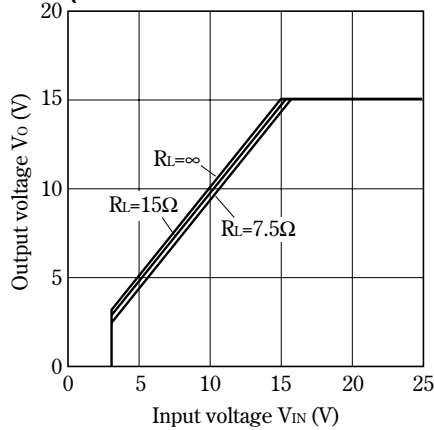

Fig.17 Circuit Operating Current vs. Input Voltage (PQ05RF2/PQ05RF21/PQ05RF2V)

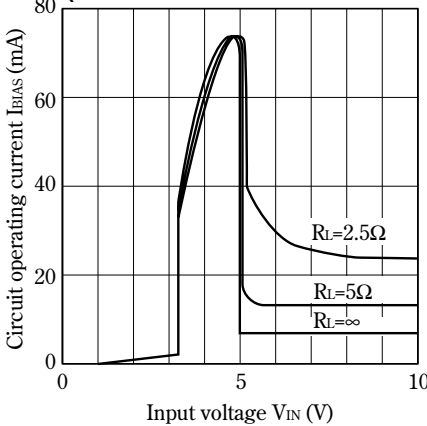
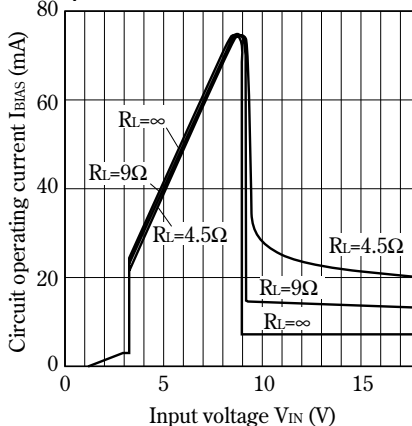
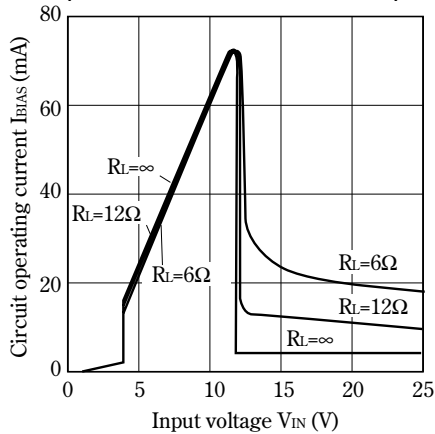

Fig.18 Circuit Operating Current vs. Input Voltage (PQ09RF2/PQ09RF21/PQ09RF2V)



**Fig.19 Circuit Operating Current vs. Input Voltage (PQ12RF2/PQ12RF21/PQ12RF2V)**



**Fig.20 Circuit Operating Current vs. Input Voltage (PQ15RF2/PQ15RF21/PQ15RF2V)**

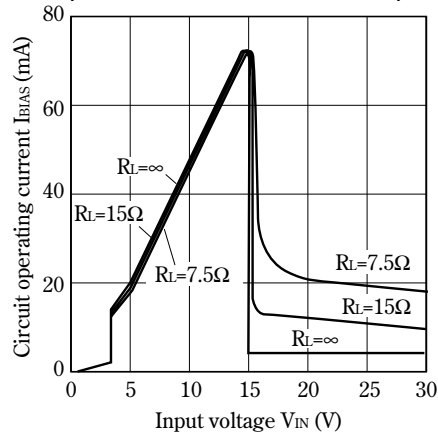

**Fig.21 Dropout Voltage vs. Junction Temperature**

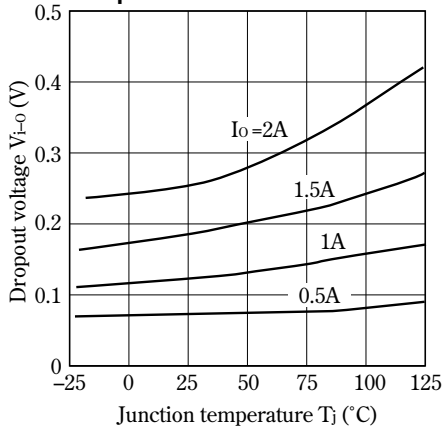

**Fig.22 Quiescent Current vs. Junction Temperature**

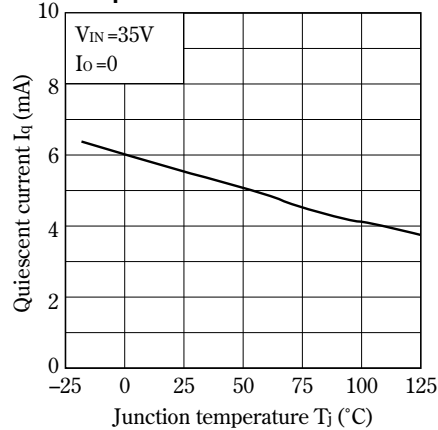

**Fig.23 Ripple Rejection vs. Input Ripple Frequency (PQ05RF2/PQ05RF21/PQ09RF2/PQ09RF21/PQ12RF2/PQ12RF21/PQ15RF2/PQ15RF21)**

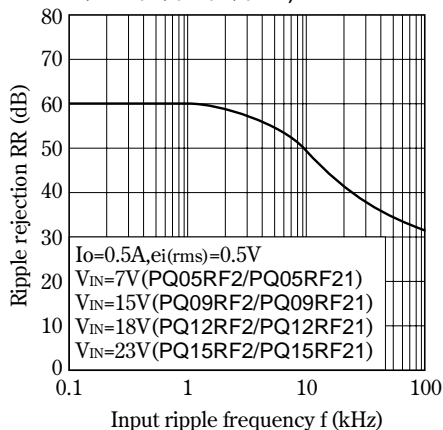

**Fig.24 Ripple Rejection vs. Input Ripple Frequency (PQ05RF2V/PQ09RF2V/PQ12RF2V/PQ15RF2V)**

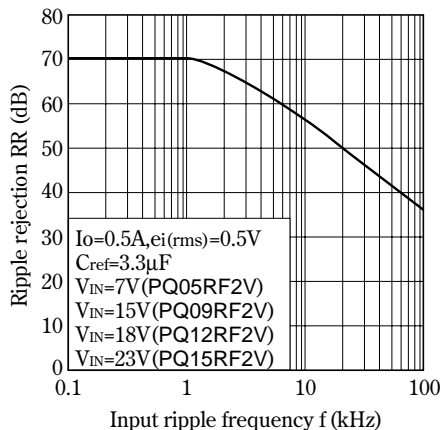
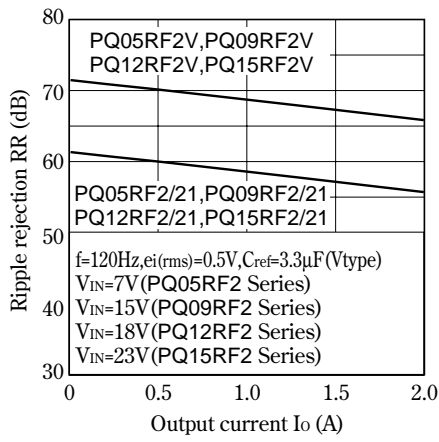

Fig.25 Ripple Rejection vs. Output Current



Typical Application

PQ05RF2/PQ05RF21 Series

PQ05RF2V Series

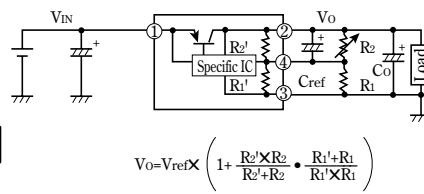
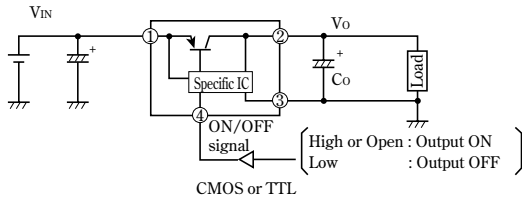

$$V_o = V_{ref} \times \left( 1 + \frac{R_2' \times R_2}{R_2' + R_2} \cdot \frac{R_1' + R_1}{R_1' \times R_1} \right)$$

Vref Nearly=1.26V, R1' Nearly=390Ω  
 PQ05RF2V : R2' Nearly=1.16kΩ  
 PQ09RF2V : R2' Nearly=2.40kΩ  
 PQ12RF2V : R2' Nearly=3.32kΩ  
 PQ15RF2V : R2' Nearly=4.45kΩ

(Note) R1' and R2' are built in a specific IC.

Model Line-ups for Lead Forming Type

Output voltage	5V Output	9V Output	12V Output	15V Output
Output voltage precision:±5%	PQ05RF2A	PQ09RF2A	PQ12RF2A	PQ15RF2A
Output voltage precision:±2.5%	PQ05RF2B	PQ09RF2B	PQ12RF2B	PQ15RF2B

■ Outline Dimensions (PQ05RF2A/PQ05RF2B Series)

(Unit : mm)

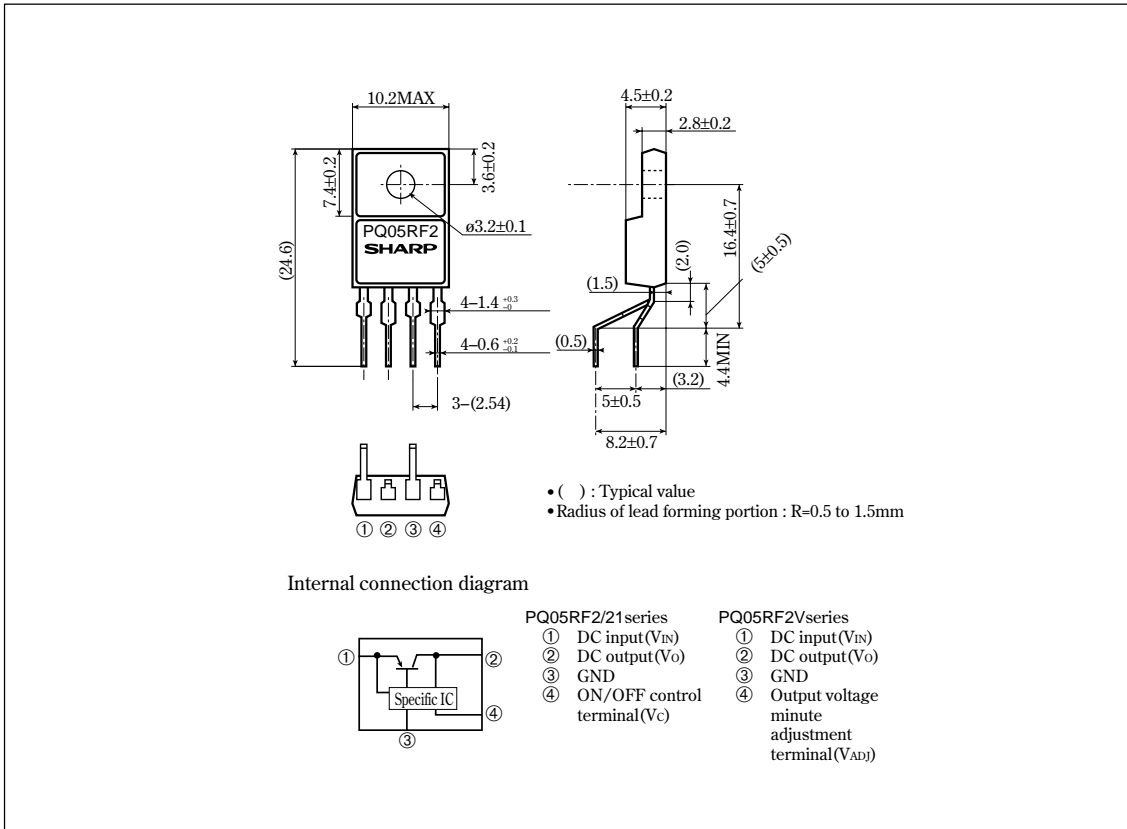

Note) The value of absolute maximum ratings and electrical characteristics is same as ones of PQ05RF2/21series.

■ Precautions for Use

(1) Minute adjustment of output voltage (PQ05RF2V series)

If the external resistor is attached to the terminals ②, ③ and ④, minute adjustment of output voltage is possible. (Refer to the example of basic circuit (PQ05RF2V series) and Fig.5 to 8.)