

**FEATURES**

- -55°C to +125°C operation
- 12 to 50 VDC input
- Fully isolated
- Magnetic feedback
- Fixed frequency 370 kHz typ.
- Topology – Current Mode Flyback
- 80 V for up to 120 ms transient protection (70 V for 15 V single and dual models)
- Inhibit function
- Short circuit protection
- Undervoltage lockout

# DC/DC CONVERTERS 28 VOLT INPUT

## MCH SERIES 1.5 WATT



MODELS	
VDC OUTPUT	
SINGLES	DUALS
5	±5
5.2	±12
12	±15
15	

Size (max.): 0.980 x 0.805 x 0.270 inches (24.89 x 20.45 x 6.86 mm)  
 Weight: 12 grams max.  
 Screening: Standard, ES, or 883 (Class H)

**DESCRIPTION**

With a miniature footprint of just 0.8 square inches, the MCH Series™ of DC/DC converters delivers 1.5 watts of output power while saving significant board real estate. The wide input voltage range of 12 to 50 VDC accepts the varying voltages of military, aerospace, or space bus power and tightly regulates output voltages to protect downstream components. Transient protection of 80 volts for up to 120 milliseconds exceeds the requirements of MIL-STD-704A for the 5, 5.2, and 12 volt single models and the 12 volt dual model. The 15 volt single and dual converters will withstand transients of up to 70 volts for up to 120 milliseconds.

**CONVERTER DESIGN**

MCH Series DC/DC converters incorporate a continuous flyback topology with a constant switching frequency of approximately 370 kHz. Current-mode pulse width modulation (PWM) provides output voltage regulation. Output error voltage is magnetically fed back to the input side of the PWM to regulate output voltage. Regulation is also affected by the load; refer to the Electrical Characteristics tables on the following pages.

Dual models regulate the negative output with magnetic coupling to the positive output. Up to 80% of the total load may be on one output providing that the other output carries a minimum of 20% of the total load. The dual models can be used at double the output voltage by connecting the load between positive and negative outputs, leaving the common unconnected. (ex: MCH2805D can be used as a 10 VDC output.)

**INHIBIT FUNCTION**

When an open collector TTL logic low is applied to the inhibit terminal, pin 7, the converter shuts down and lowers the output voltage to near zero and input current to as low as 2.3 mA. Leaving the terminal open or applying an open collector TTL logic high will enable the converter.

**PROTECTION FEATURES**

Undervoltage lockout prevents the MCH Series converters from operating below approximately 8 VDC input voltage to keep system current levels smooth, especially during initialization or re-start operations. All models include a soft-start function to prevent large current draw and minimize overshoot. The converters also provide short circuit protection by restricting the current.

**MIL-STD-461**

Use Interpoint's FMSA-461 EMI filter to pass the CE03 requirements of MIL-STD-461C.

**CONVENIENT PACKAGING**

The MCH Series converters are packaged in hermetically sealed, projection-welded metal cases which provide EMI/RFI shielding.

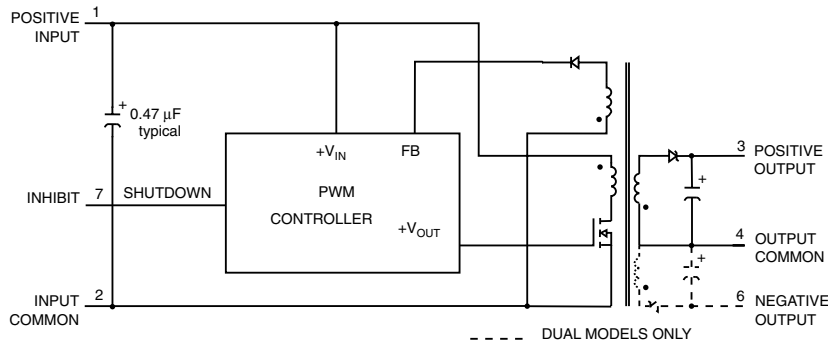

**FIGURE 1: BLOCK DIAGRAM**

# MCH SERIES 1.5 WATT

# DC/DC CONVERTERS

ABSOLUTE MAXIMUM RATINGS	
<b>Input Voltage</b>	• 12 to 50 VDC
<b>Output Power</b>	• 1.5 W
<b>Capacitive Load</b>	• Single output models 200 $\mu$ F • Dual output models 100 $\mu$ F
<b>Lead Soldering Temperature (10 sec per lead)</b>	• 300°C
<b>Storage Temperature Range (Case)</b>	• -65°C to +150°C

INHIBIT	
<b>Inhibit – TTL Open Collector</b>	• Logic low (output disabled) 0.8 V max Inhibit pin current 1 mA max
	• Referenced to input common
	• Logic high (output enabled) open collector

RECOMMENDED OPERATING CONDITIONS	
<b>Input Voltage Range</b>	• 12 to 50 VDC continuous • 80 V for 120 msec transient (70 V for 15 V single and dual models)
<b>Case Operating Temperature (Tc)</b>	• -55°C to +125°C full power • -55°C to +135°C absolute
<b>Derating Output Power/Current (Tc)</b>	• Linearly from 100% at 125°C to 0% at 135°C

TYPICAL CHARACTERISTICS	
<b>Output Voltage Temperature Coefficient</b>	• 100 ppm/°C typical
<b>Input to Output Capacitance</b>	• 100 to 170 pF typical
<b>Undervoltage Lockout</b>	• 8 V input typical
<b>Current Limit</b>	• 125% of full load typical
<b>Isolation</b>	• 100 megohm minimum at 500 V
<b>Audio Rejection 40 dB, typical Conversion Frequency (kHz)</b>	• 25°C, 300 min, 370 typ, 450 max • -55°C to +125°C 270 min, 370 typ, 470 max
<b>Inhibit Pin Voltage (unit enabled)</b>	• 7 to 12 V

### Electrical Characteristics: 25°C Tc, 28 VDC Vin, 100% load, unless otherwise specified.

SINGLE OUTPUT MODELS		MCH2805S			MCH285R2S			MCH2812S			MCH2815S			UNITS
PARAMETER	CONDITIONS	MIN	TYP	MAX	MIN	TYP	MAX	MIN	TYP	MAX	MIN	TYP	MAX	
OUTPUT VOLTAGE <sup>1</sup>	Tc = 25°C	4.95	5	5.05	5.15	5.2	5.25	11.88	12	12.12	14.85	15	15.15	VDC
	Tc = -55°C TO +125°C	4.80	5	5.20	5.00	5.2	5.40	11.52	12	12.48	14.40	15	15.60	
OUTPUT CURRENT	V <sub>IN</sub> = 12 to 50 VDC	—	300	0	—	288	0	—	125	0	—	100	—	mA
OUTPUT POWER	V <sub>IN</sub> = 12 TO 50 VDC	0	—	1.5	0	—	1.5	0	—	1.5	0	—	1.5	W
OUTPUT RIPPLE VOLTAGE	10 kHz - 2 MHz	—	45	150	—	45	150	—	50	200	—	35	150	mV p-p
	Tc = -55°C TO +125°C	—	65	300	—	65	300	—	70	300	—	50	250	
LINE REGULATION	V <sub>IN</sub> = 12 TO 50 VDC	—	35	100	—	35	100	—	60	200	—	70	300	mV
	Tc = -55°C TO +125°C	—	40	120	—	40	120	—	70	250	—	80	350	
LOAD REGULATION	10% TO FULL LOAD	—	350	700	—	350	700	—	600	1300	—	700	1500	mV
	Tc = -55°C TO +125°C	—	380	800	—	380	800	—	640	1400	—	760	1600	
	50% TO FULL	—	100	200	—	100	200	—	145	300	—	165	350	
	Tc = -55°C TO +125°C	—	115	300	—	115	300	—	160	400	—	185	450	
INPUT VOLTAGE	CONTINUOUS	12	28	50	12	28	50	12	28	50	12	28	50	VDC
NO LOAD TO FULL	TRANSIENT 120 ms	0	—	80	0	—	80	0	—	80	0	—	70	V
INPUT CURRENT	NO LOAD	—	5.5	10	—	5.5	10	—	6.0	10	—	6.0	11	mA
	Tc = -55°C TO +125°C	—	6.0	11	—	6.0	11	—	6.5	12	—	6.5	12	
	FULL LOAD	—	70	74	—	70	74	—	68	72	—	68	72	
	Tc = -55°C TO +125°C	—	73	78	—	73	78	—	70	74	—	70	74	
	INHIBITED	—	2.3	3.2	—	2.3	3.2	—	2.3	3.2	—	2.3	3.2	
	Tc = -55°C TO +125°C	—	2.4	3.5	—	2.4	3.5	—	2.4	3.5	—	2.4	3.5	
INPUT RIPPLE CURRENT <sup>2</sup>	10k Hz - 10 MHz	—	100	200	—	100	200	—	100	200	—	100	200	mA p-p
	Tc = -55°C TO +125°C	—	130	250	—	130	250	—	150	250	—	150	250	
EFFICIENCY	Tc = 25°C	72	77	—	72	77	—	74	79	—	74	79	—	%
	Tc = -55°C TO +125°C	69	75	—	69	75	—	72	77	—	72	77	—	
LOAD FAULT <sup>3, 4</sup>	POWER DISSIPATION	—	1.3	2.0	—	1.3	2.0	—	2.0	3.2	—	2.3	3.7	W
	Tc = -55°C TO +125°C	—	1.4	2.3	—	1.4	2.3	—	2.2	3.5	—	2.5	4.0	
	RECOVERY	—	3.0	12	—	3.0	12	—	3.5	15	—	4.0	18	
	Tc = -55°C TO +125°C	—	3.5	15	—	3.5	15	—	3.5	20	—	4.0	20	ms
STEP LOAD RESPONSE <sup>5</sup>	50 %-100%- 50% LOAD TRANSIENT	-400	185	400	-400	185	400	-700	350	700	-700	350	700	mV pk
	Tc = -55°C TO +125°C	-500	185	500	-500	185	500	-800	380	800	-800	380	800	
	RECOVERY	—	125	500	—	125	500	—	130	500	—	140	600	
	Tc = -55°C TO +125°C	—	125	600	—	125	600	—	130	600	—	180	750	$\mu$ s
STEP LINE RESPONSE <sup>5</sup>	12 TO 50 TO 12 V <sub>IN</sub> TRANSIENT	-400	170	400	-400	170	400	-900	400	900	-750	400	750	mV pk
	Tc = -55°C TO +125°C	-500	180	500	-500	180	500	-1000	400	1000	-850	450	850	
	RECOVERY	—	0.75	3.0	—	0.75	3.0	—	0.6	2.5	—	0.47	2.0	
	Tc = -55°C TO +125°C	—	0.75	4.0	—	0.75	4.0	—	0.6	3.0	—	0.5	2.5	ms
START-UP 0 TO 28 VDC	DELAY	—	7	20	—	7	20	—	7	20	—	7	20	ms
	Tc = -55°C TO +125°C	—	10	40	—	10	40	—	10	40	—	10	40	
	OVERSHOOT	—	0	100	—	0	100	—	0	250	—	0	300	
	Tc = -55°C TO +125°C	—	0	150	—	0	150	—	0	350	—	0	450	mV pk

See notes 1, 2, 3, 4, 5, and 6 on the following page.

# DC/DC CONVERTERS

# MCH SERIES 1.5 WATT

Electrical Characteristics: 25°C Tc, 28 VDC Vin, 100% load, unless otherwise specified.

DUAL OUTPUT MODELS		MCH2805D			MCH2812D			MCH2815D			UNITS
PARAMETER	CONDITIONS	MIN	TYP	MAX	MIN	TYP	MAX	MIN	TYP	MAX	
OUTPUT VOLTAGE <sup>1</sup>	Tc = 25°C	±4.95	±5	±5.05	±11.88	±12	±12.12	±14.85	±15	±15.15	VDC
	Tc = -55°C TO +125°C	±4.80	±5	±5.20	±11.52	±12	±12.48	±14.40	±15	±15.60	
OUTPUT CURRENT <sup>6</sup>	V <sub>IN</sub> = 12 TO 50 VDC	0	±150	240	0	±62.5	100	0	±50	80	mA
OUTPUT POWER	V <sub>IN</sub> = 12 TO 50 VDC	0	—	1.5	0	—	1.5	0	—	1.5	W
OUTPUT RIPPLE VOLTAGE +V <sub>OUT</sub>	10 kHz - 2 MHz	—	35	150	—	35	150	—	30	150	mV p-p
	Tc = -55°C TO +125°C	—	50	250	—	40	250	—	35	250	
-V <sub>OUT</sub>	10 kHz - 2 MHz	—	35	150	—	35	150	—	30	150	mV p-p
	Tc = -55°C TO +125°C	—	50	250	—	40	250	—	35	250	
LINE REGULATION <sup>7</sup>	V <sub>IN</sub> = 12 TO 50 VDC	—	10	50	—	100	300	—	165	500	mV
	Tc = -55°C TO +125°C	—	20	100	—	110	400	—	180	650	
LOAD REGULATION <sup>8</sup> ±V <sub>OUT</sub>	10% TO FULL	—	300	600	—	550	1100	—	600	1300	mV
	-55°C TO +125°C	—	350	700	—	570	1200	—	630	1400	
	50% TO FULL	—	80	200	—	115	250	—	125	300	
INPUT VOLTAGE NO LOAD TO FULL	CONTINUOUS	12	28	50	12	28	50	12	28	50	VDC
	TRANSIENT 120 ms	0	—	80	0	—	80	0	—	70	V
INPUT CURRENT	NO LOAD	—	5.0	10	—	7.5	13	—	7.5	13	mA
	Tc = -55°C TO +125°C	—	6.0	12	—	8.0	14	—	8.0	14	
	FULL LOAD	—	69	73	—	70	73	—	71	74	
	Tc = -55°C TO +125°C	—	72	77	—	71	77	—	72	78	
	INHIBITED	—	2.3	3.2	—	2.3	3.2	—	2.3	3.2	
INPUT RIPPLE <sup>2</sup> CURRENT	10 kHz - 10 MHz	—	100	200	—	115	200	—	90	200	mA p-p
	Tc = -55°C TO +125°C	—	130	250	—	150	250	—	120	250	
EFFICIENCY	Tc = 25°C	73	77	—	73	77	—	72	76	—	%
	Tc = -55°C TO +125°C	70	75	—	70	75	—	69	74	—	
LOAD FAULT <sup>3,4</sup>	POWER DISSIPATION	—	1.4	2.2	—	2.5	3.8	—	2.7	4.1	W
	Tc = -55°C TO +125°C	—	1.6	2.5	—	2.7	4.2	—	3.0	4.5	
	RECOVERY	—	3.7	15	—	3.2	15	—	4.0	15	ms
Tc = -55°C TO +125°C	RECOVERY	—	3.8	20	—	3.2	20	—	4.0	20	
	50%–100%–50% LOAD	—	3.8	20	—	3.2	20	—	4.0	20	
STEP LOAD RESPONSE <sup>5</sup> ± V <sub>OUT</sub>	TRANSIENT	-300	130	300	-600	250	600	-600	250	600	mV pk
	Tc = -55°C TO +125°C	-400	140	400	-700	260	700	-700	270	700	
	RECOVERY	—	100	400	—	165	700	—	50	200	μs
-55°C TO +125°C	RECOVERY	—	100	500	—	165	800	—	50	300	
	12 TO 50 TO 12 V <sub>IN</sub>	—	100	500	—	165	800	—	50	300	
STEP LINE RESPONSE <sup>5</sup> ± V <sub>OUT</sub>	TRANSIENT	-250	125	250	-500	240	500	-500	220	500	mV pk
	Tc = -55°C TO +125°C	-300	130	300	-600	250	600	-600	230	600	
	RECOVERY	—	0.6	2.5	—	0.9	3.0	—	0.6	3.0	ms
Tc = -55°C TO +125°C	RECOVERY	—	0.6	3.0	—	0.9	4.0	—	0.7	4.0	
	DELAY	—	8	25	—	8	25	—	8	25	ms
START-UP 0 TO 28 VDC, ± V <sub>OUT</sub>	Tc = -55°C TO +125°C	—	10	45	—	10	45	—	10	45	
	OVERSHOOT	—	0	100	—	0	250	—	0	750	mV pk
Tc = -55°C TO +125°C	OVERSHOOT	—	0	150	—	0	350	—	0	900	

Notes:

- Specified at 50% load.
- Lin = 2 μH.
- Maximum duration of short circuit: 25°C— 90 seconds, 125°C – 30 seconds.
- Load fault is a short circuit (<50 mohms). Recovery is into resistive full load.
- Transition ≥ 10 μs. Recovery = time to settle to within 1% of Vout final value.
- Max. spec indicates 80% of the converter's total power, available from either output.
- Specification applies to both + and - Vout.
- Although no minimum load is required, at no load the output voltage may increase up to 15%.

**MCH SERIES  
1.5 WATT**

**DC/DC CONVERTERS**

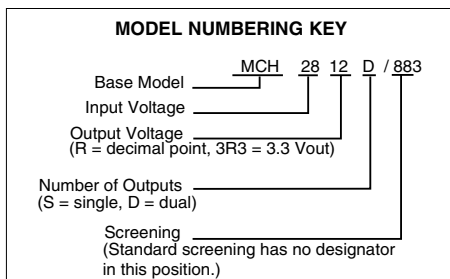
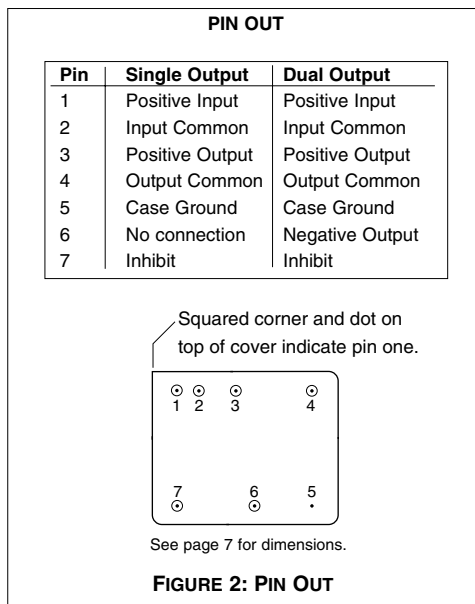

**SMD NUMBERS**

STANDARD MICROCIRCUIT DRAWING (SMD)	MCH SERIES SIMILAR PART
5962-9569601HXC	MCH2805S/883
IN PROCESS	MCH285R2S/883
5962-9569701HXC	MCH2812S/883
5962-9569801HXC	MCH2815S/883
5962-9570201HXC	MCH2805D/883
5962-9570301HXC	MCH2812D/883
5962-9570401HXC	MCH2815D/883

For exact specifications for an SMD product, refer to the SMD drawing. Call your Interpoint representative for status on the MCH Series SMD releases which are "in process". SMDs can be downloaded from <http://www.dscccols.com/programs/smcr>

# DC/DC CONVERTERS

# MCH SERIES 1.5 WATT

**TYPICAL PERFORMANCE CURVES:  $T_c = 25^\circ\text{C}$ , full load,  $V_{in} = 28\text{ VDC}$ , unless otherwise specified.**

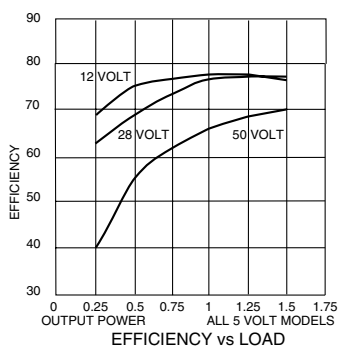

**FIGURE 3**

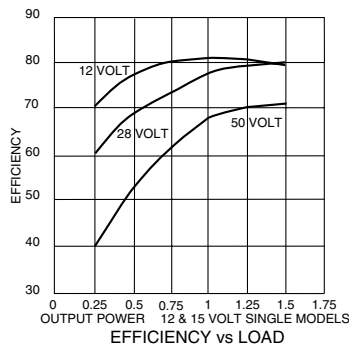

**FIGURE 4**

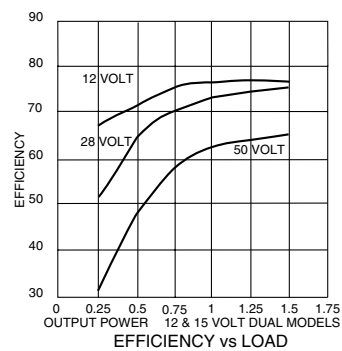

**FIGURE 5**

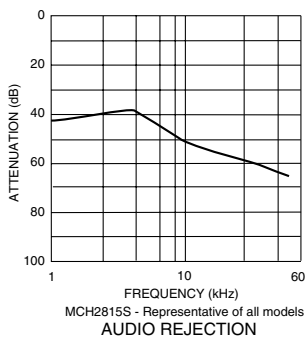

**FIGURE 6**

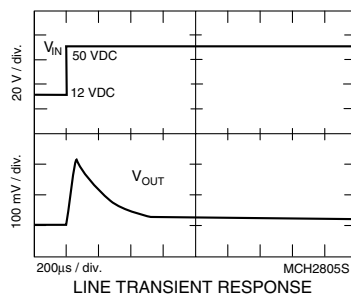

**FIGURE 7**

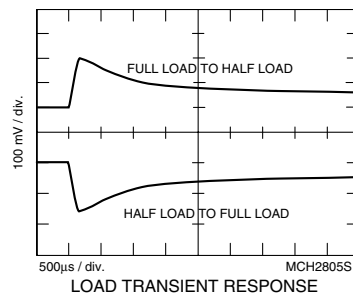

**FIGURE 8**

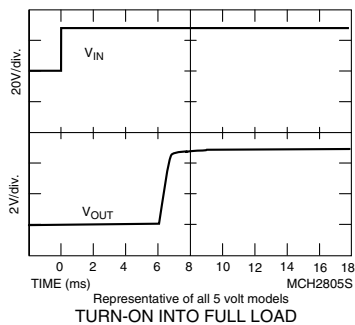

**FIGURE 9**

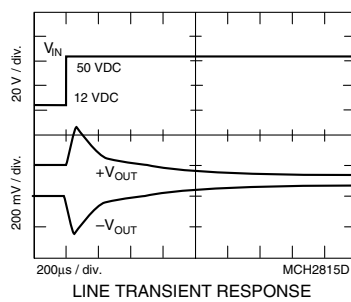

**FIGURE 10**

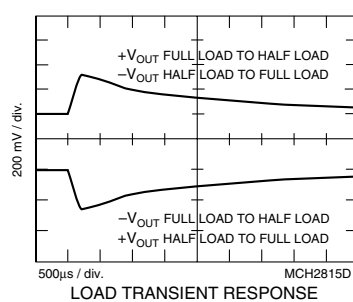

**FIGURE 11**

# MCH SERIES 1.5 WATT

# DC/DC CONVERTERS

TYPICAL PERFORMANCE CURVES:  $T_c = 25^\circ\text{C}$ , full load,  $V_{in} = 28\text{ VDC}$ , unless otherwise specified.

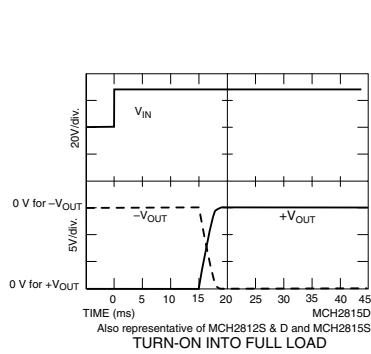

FIGURE 12

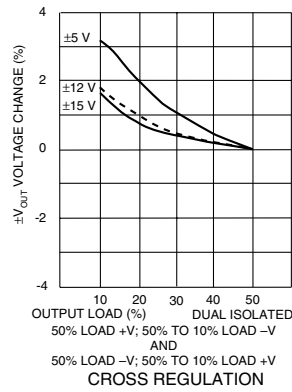

FIGURE 13

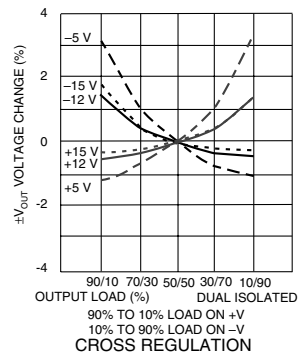

FIGURE 14

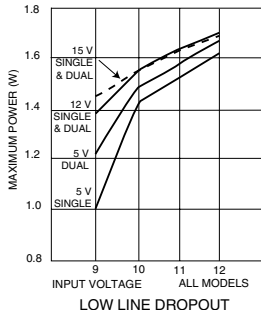

FIGURE 15

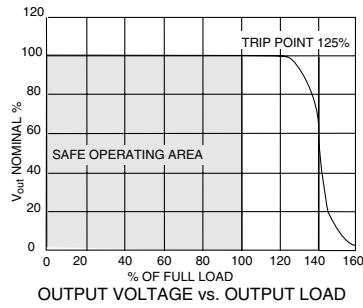

FIGURE 16

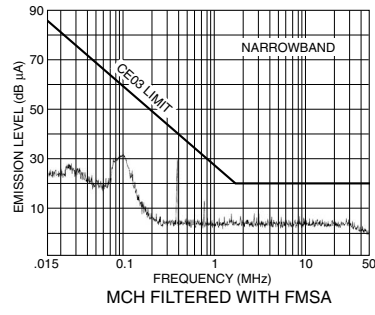
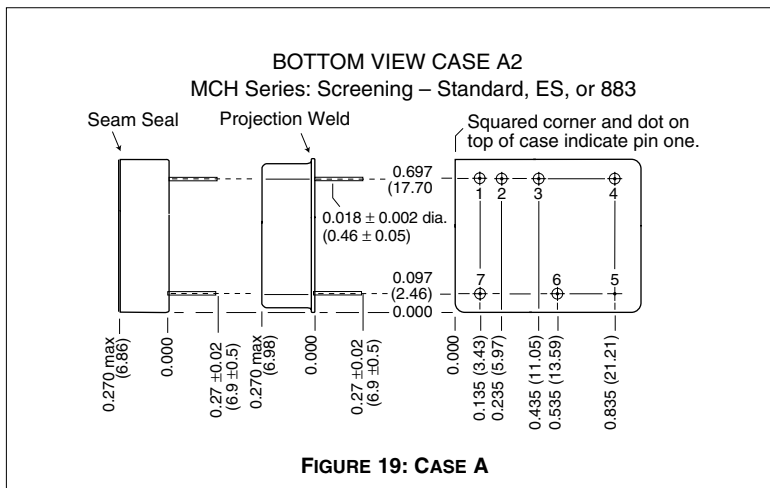
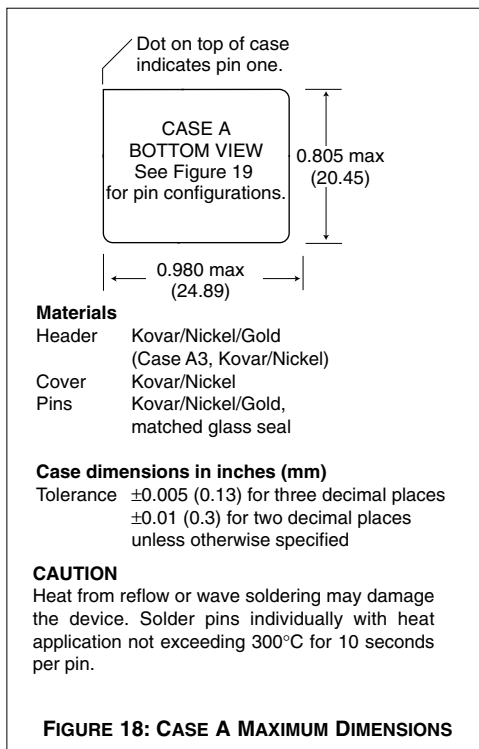

FIGURE 17

# DC/DC CONVERTERS

# MCH SERIES 1.5 WATT



Note: Although every effort has been made to render the case drawings at actual size, variations in the printing process may cause some distortion. Please refer to the numerical dimensions for accuracy.

**MCH SERIES  
1.5 WATT**

**DC/DC CONVERTERS**

**ENVIRONMENTAL SCREENING**

TEST	125°C STANDARD	125°C /ES	/883 (Class H)*
PRE-CAP INSPECTION Method 2017, 2032	yes	yes	yes
TEMPERATURE CYCLE (10 times) Method 1010, Cond. C, -65°C to 150°C Method 1010, Cond. B, -55°C to 125°C	no no	no yes	yes no
CONSTANT ACCELERATION Method 2001, 3000 g Method 2001, 500 g	no no	no yes	yes no
BURN-IN Method 1015, 160 hours at 125°C 96 hours at 125°C case (typical)	no no	no yes	yes no
FINAL ELECTRICAL TEST MIL-PRF-38534, Group A Subgroups 1 through 6: -55°C, +25°C, +125°C Subgroups 1 and 4: +25°C case	no yes	no yes	yes no
HERMETICITY TESTING Fine Leak, Method 1014, Cond. A Gross Leak, Method 1014, Cond. C Gross Leak, Dip (1 x 10 <sup>-3</sup> )	no no yes	yes yes no	yes yes no
FINAL VISUAL INSPECTION Method 2009	yes	yes	yes

Test methods are referenced to MIL-STD-883 as determined by MIL-PRF-38534.

\*883 products are built with element evaluated components and are 100% tested and guaranteed over

**Contact Information:**

[www.interpoint.com](http://www.interpoint.com)

Interpoint Headquarters USA  
Phone: 1-800-822-8782  
+425-882-3100  
Email: [power@intp.com](mailto:power@intp.com)

Interpoint UK  
Phone: +44-1252-872266  
Email: [poweruk@intp.com](mailto:poweruk@intp.com)

Interpoint France  
Phone: +33-134285455  
Email: [powerfr@intp.com](mailto:powerfr@intp.com)