



# TAI-SAW TECHNOLOGY CO., LTD.

No. 3, Industrial 2nd Rd., Ping-Chen Industrial District,  
Taoyuan, 324, Taiwan, R.O.C.

TEL: 886-3-4690038 FAX: 886-3-4697532

E-mail: [tstsales@mail.taisaw.com](mailto:tstsales@mail.taisaw.com) Web: [www.taisaw.com](http://www.taisaw.com)

## Approval Sheet For Product Specification

Issued Date:

Product Name: SAW Filter 220MHz SMD 5.0×5.0 mm

TST Parts No.:TA0369A

Customer Parts No.:\_\_\_\_\_

Company: _____
Division: _____
Approved by : _____
Date: _____

Checked by: \_\_\_\_\_ Elvis Chiu

Approval by: \_\_\_\_\_ Francis Chen

Date: \_\_\_\_\_ 2004/07/15



# TAI-SAW TECHNOLOGY CO., LTD.

No. 3, Industrial 2nd Rd., Ping-Chen Industrial District,  
Taoyuan, 324, Taiwan, R.O.C.

TEL: 886-3-4690038 FAX: 886-3-4697532

E-mail: [tstsales@mail.taisaw.com](mailto:tstsales@mail.taisaw.com) Web: [www.taisaw.com](http://www.taisaw.com)

## SAW Filter 220 MHz

MODEL NO.: TA0369A

REV. NO.:1

### A. MAXIMUM RATING:

1. Input Power Level: 10 dB<sub>m</sub>
2. DC voltage: 5 V
3. Operating Temperature: -40°C to +85°C
4. Storage Temperature: -40°C to +85°C

RoHS Compliant  
Lead free  
Lead-free soldering

### B. ELECTRICAL CHARACTERISTICS:

Item		Min.	Typical	Max.
<b>Center frequency</b>	<b>F<sub>c</sub></b> (dB)	-	220	-
<b>Insertion loss</b>	218~222 MHz <b>IL</b> (dB)	-	2.8	4.2
<b>Amplitude ripple</b>	218~222 MHz (dB)	-	1.0	2.2
<b>Attenuation</b> (Reference level from 0 dB)				
F <sub>C</sub> - 100 ~ F <sub>C</sub> - 40	MHz (dB)	42	58	-
F <sub>C</sub> + 40 ~ F <sub>C</sub> + 100	MHz (dB)	42	57	-
<b>Source impedance</b>	Z <sub>s</sub> (Ω)	-	50Ω//0pF	-
<b>Load impedance</b>	Z <sub>L</sub> (Ω)	-	50Ω//0pF	-

Note1. The standard definitions is in JIS C 6703

Note2.

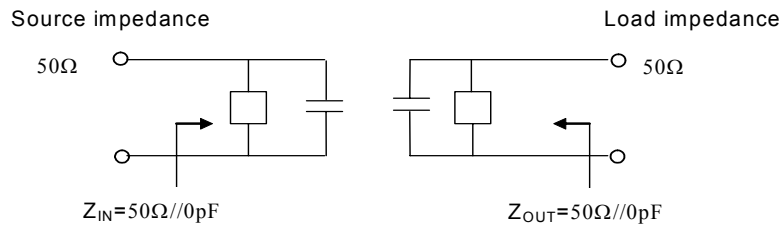

### C. Frequency Characteristics :

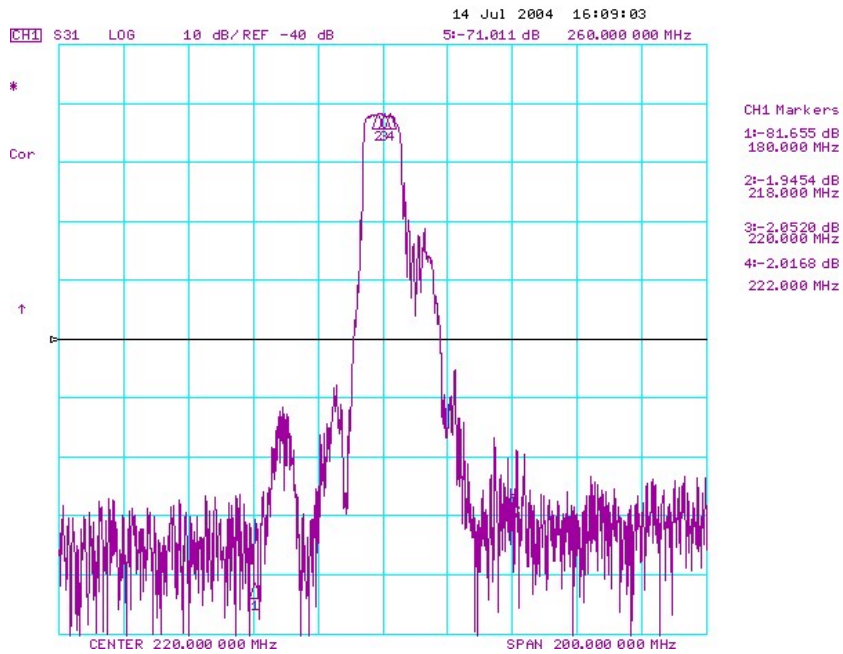
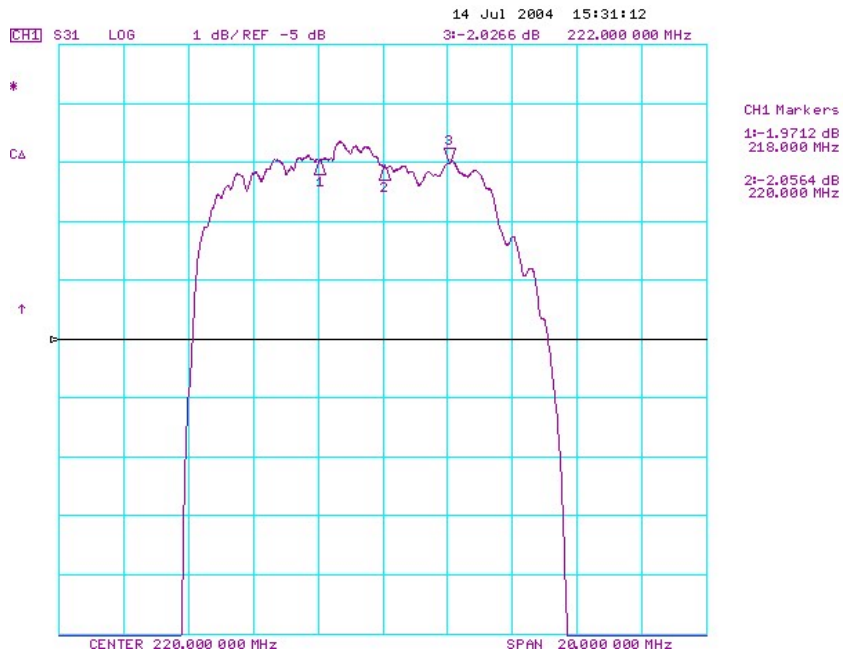

**D. MEASUREMENT CIRCUIT:**

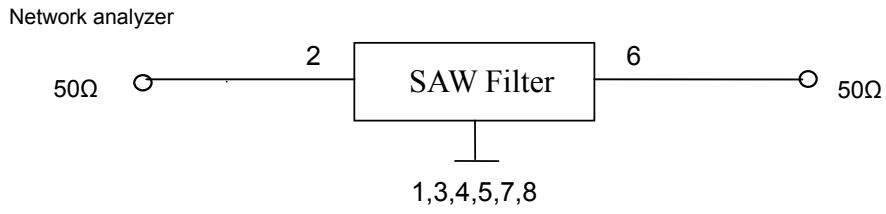

**E. OUTLINE DRAWING:**

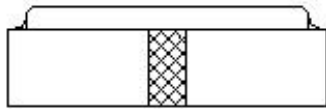
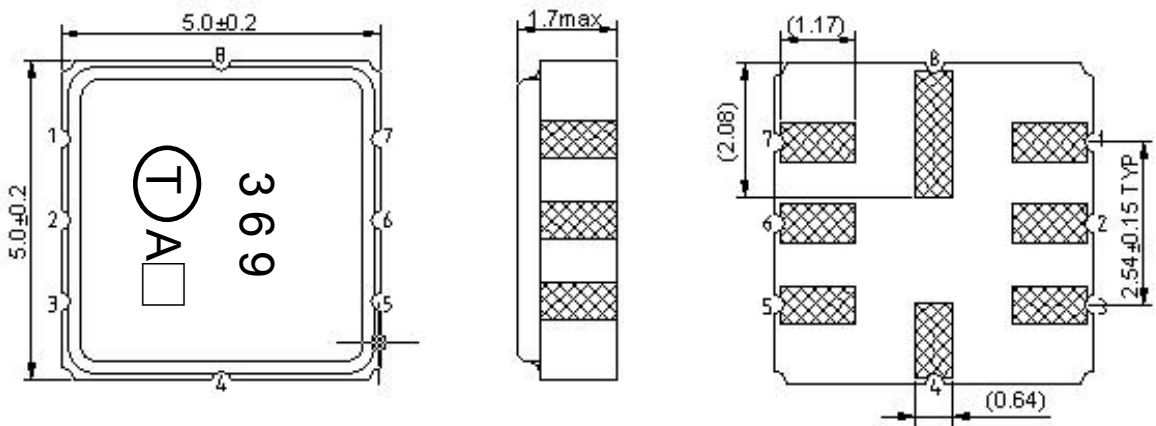

#2: Input  
 #6: Output  
 #1,3,4,5,7,8: Ground  
 □ : Date Code  
 Unit: mm

**F. PCB FOOTPRINT**

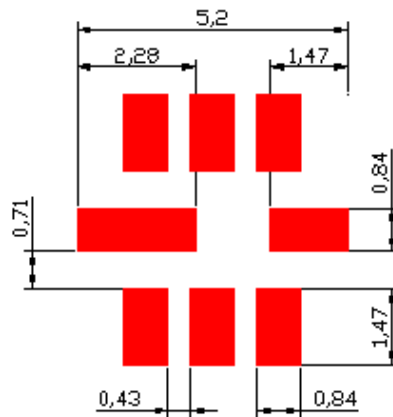

## G. PACKING:

### 1. REEL DIMENSION

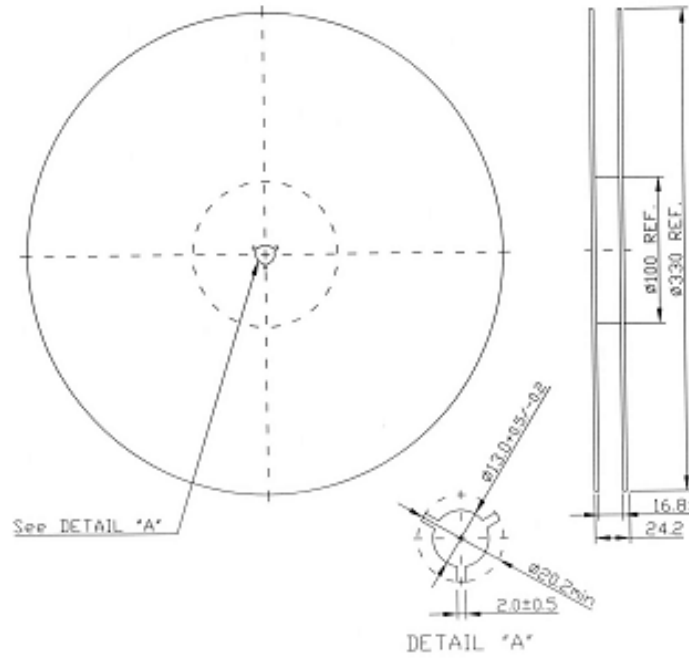

### 2. TAPE DIMENSION

