

**PLEASE CHECK WWW.MOLEX.COM FOR LATEST PART INFORMATION**

**Part Number:** [5023860770](#)  
**Status:** **Active**  
**Description:** 1.25mm (.049") Pitch CLIK-Mate™ Wire-to-Board PCB Receptacle, Single Row, Right Angle, 7 Circuits

**Documents:**

[3D Model](#) [Product Specification PS-502382-001 \(PDF\)](#)  
[Application Specification \(PDF\)](#) [RoHS Certificate of Compliance \(PDF\)](#)  
[Drawing \(PDF\)](#)

**General**

Product Family	PCB Receptacles
Series	<a href="#">502386</a>
Application	Wire-to-Board
Product Name	CLIK-Mate™

**Physical**

Circuits (Loaded)	7
Circuits (maximum)	7
Color - Resin	Natural
Durability (mating cycles max)	30
Glow-Wire Compliant	No
Guide to Mating Part	Yes
Keying to Mating Part	Yes
Lock to Mating Part	Yes
Mated Height (in)	0.219 In
Mated Height (mm)	5.55 mm
Material - Plating Mating	Tin
Material - Plating Termination	Tin
Material - Resin	High Temperature Thermoplastic
Number of Rows	1
Orientation	Right Angle
PCB Locator	No
PCB Retention	None
Packaging Type	Embossed Tape on Reel
Pitch - Mating Interface (in)	0.049 In
Pitch - Mating Interface (mm)	1.25 mm
Pitch - Term. Interface (in)	0.049 In
Pitch - Term. Interface (mm)	1.25 mm
Plating min: Mating (µin)	40
Plating min: Mating (µm)	1
Plating min: Termination (µin)	40
Plating min: Termination (µm)	1
Polarized to Mating Part	Yes
Polarized to PCB	No
Stackable	No
Surface Mount Compatible (SMC)	Yes
Temperature Range - Operating	-25°C to +85°C
Termination Interface: Style	Surface Mount

**Electrical**

Current - Maximum per Contact	1A
Voltage - Maximum	50V AC (RMS)/DC

**Material Info**

**Reference - Drawing Numbers**

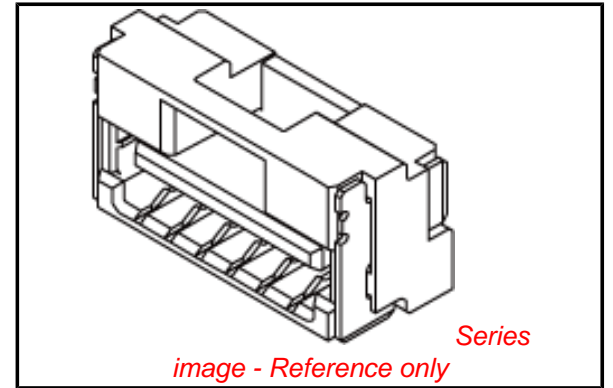

**EU RoHS**

**ELV and RoHS Compliant**  
**REACH SVHC**  
 Not Reviewed  
**Halogen-Free Status**  
 Not Reviewed

**China RoHS**



**Need more information on product environmental compliance?**

Email [productcompliance@molex.com](mailto:productcompliance@molex.com)  
 For a multiple part number RoHS Certificate of Compliance, [click here](#)

Please visit the [Contact Us](#) section for any non-product compliance questions.

**Search Parts in this Series**

[502386Series](#)

**Mates With**

[502380 Crimp Housing](#)

Packaging Specification  
Product Specification

Sales Drawing

SPK-502386-001  
PS-502382-001, RPS-502382-003, RPS-502382-005,  
RPS-502382-006, RPS-502382-008, RPS-502382-011,  
RPS-502382-012, RPS-502382-013  
SD-502386-001, SD-502386-003

This document was generated on 05/24/2010

**PLEASE CHECK [WWW.MOLEX.COM](http://WWW.MOLEX.COM) FOR LATEST PART INFORMATION**

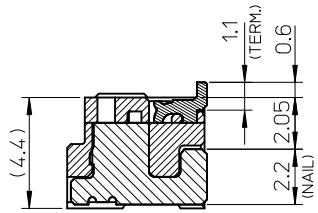
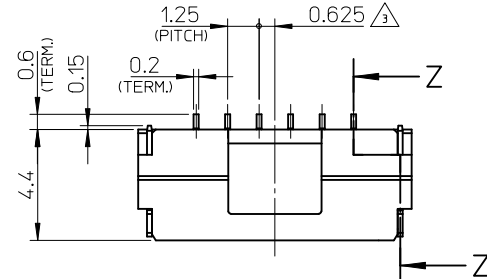

SECTION Z-Z

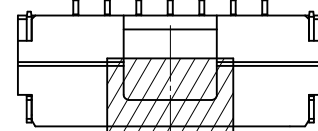

カプトンテープ付き  
WITH KAPTON TAPE

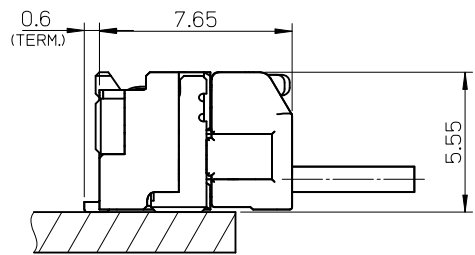
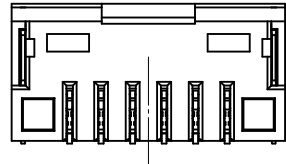
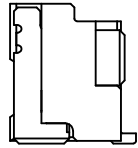
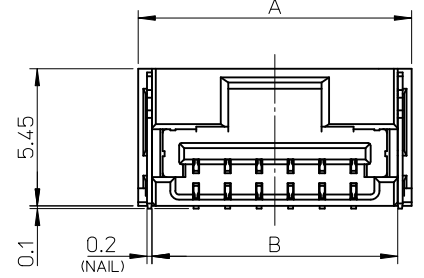
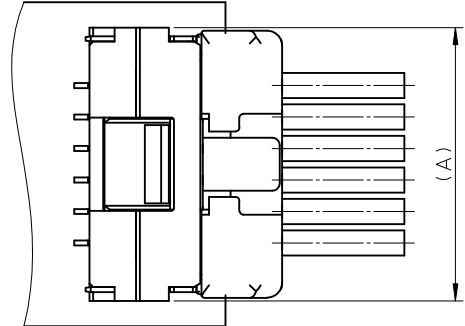

嵌合図  
MATED CONNECTORS

NOTES

- 嵌合相手: 502380-\*\*\*\*  
MATE WITH : 502380-\*\*\*\*
- 端子テール部 及び ネイルの平坦度: 0.1MAX.  
TAIL AND NAIL COPLANARITY TO BE 0.1 MAX.
- 極数/2=偶数に適用。  
APPLY FOR CKT. SIZE / 2 = EVEN.
- 端子テール部 及び ネイルに錫めっきを使用しているため、  
外観に摺動痕が付く場合が御座います。  
THE WOUND OF FRICTION MIGHT ADHERE TO EXTERNALS  
BECAUSE THE TIN PLATING IS USED FOR THA TAIL AND NAIL.
- 本製品のプラスチック部に黒点等が確認される場合や  
色合いが異なる場合がありますが、製品性能に影響はありません。  
THERE IS NO INFLUENCE IN THE PRODUCT PERFORMANCE THOUGH  
THE BLACK SPOT ETC. MIGHT BE CONFIRMED TO THE PLASTIC PART  
OF THIS PRODUCT AND THE SHADE MIGHT BE DIFFERENT.
- ELV 及び RoHS 適合品  
ELV AND RoHS COMPLIANT

3.4	7.5	11	12.1	502386-07**	7
3.4	6.25	9.75	10.85	502386-06**	6
3.4	5	8.5	9.6	502386-05**	5
3.4	3.75	7.25	8.35	502386-04**	4
2.6	2.5	6	7.1	502386-03**	3
2.2	1.25	4.75	5.85	502386-02**	2
D	C	B	A	EMBOSSSED TAPE PACKAGE オーダー番号 ORDER No.	極数 (CKT. NO.)

番号 NO.	部品 PART	材質 MATERIAL
①	ハウジング HOUSING	耐熱性樹脂 UL94V-0 色:SHEET 3 参照 HEATPROOF RESIN UL94V-0 COLOR : SEE SHEET 3
②	ターミナル TERMINAL	銅合金 COPPER ALLOY 錫めっき : 1.0 micro-meter MIN. TIN (TAIL AREA) ニッケルめっき(下地): 1.0 micro-meter MIN. NICKEL (UNDER PLATING)
③	ネイル NAIL	銅合金 COPPER ALLOY 錫めっき: 1.0 micro-meter MIN. TIN ニッケルめっき(下地): 1.0 micro-meter MIN. NICKEL (UNDER PLATING)

REVISED EC NO.: J2010-2320 DRWN: YGOTO 2010/05/19 CHKD: K. ASAKAWA 2010/05/20 APPR: NUKITA 2010/05/21	GENERAL TOLERANCES (UNLESS SPECIFIED)		DIMENSION STYLE MM ONLY		SCALE 5:1	DESIGN UNITS METRIC	THIRD ANGLE PROJECTION
	10 UNDER	±0.2	DRAWN BY T. MIYAZAKI	DATE 2006/08/28	TITLE 1.25 W/B CONN. SINGLE R/A REC. ASS'Y 2-7CKT.		
	10 OVER 30 UNDER	±0.25	CHECKED BY K. ASAKAWA	DATE 2006/08/28	APPROVED BY YO. ITO 2006/08/28		
	30 OVER	±0.3	MATERIAL NO. SEE TABLE		DOCUMENT NO. SD-502386-001		SHEET NO. 1 OF 3
REV	DESCRIPTION	ANGULAR ±3 °		THIS DRAWING CONTAINS INFORMATION THAT IS PROPRIETARY TO MOLEX INCORPORATED AND SHOULD NOT BE USED WITHOUT WRITTEN PERMISSION			
DRAFT WHERE APPLICABLE MUST REMAIN WITHIN DIMENSIONS							

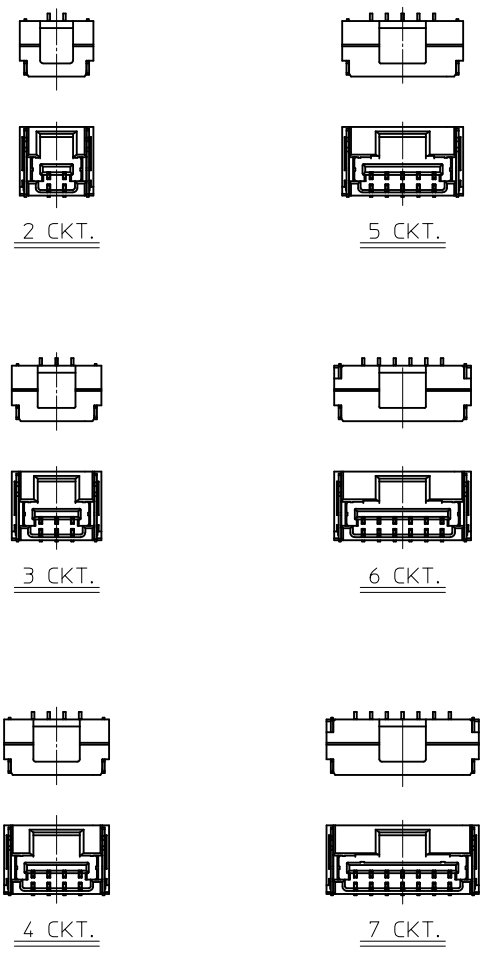

極数の種類  
KIND OF CKT. NO.(FRONT VIEW)

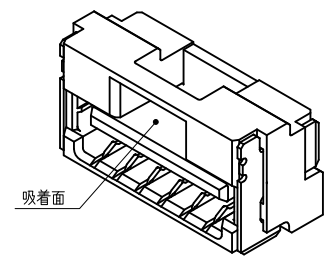
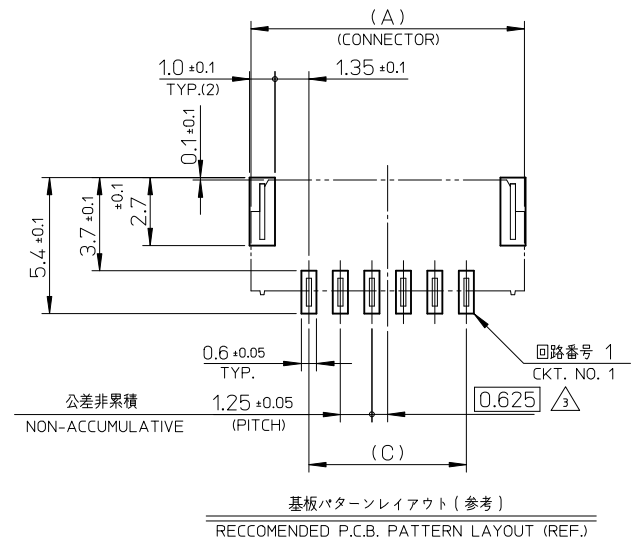
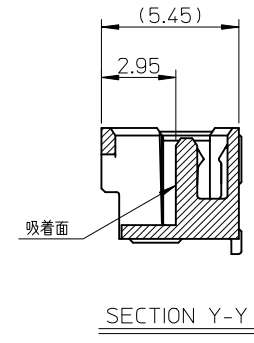
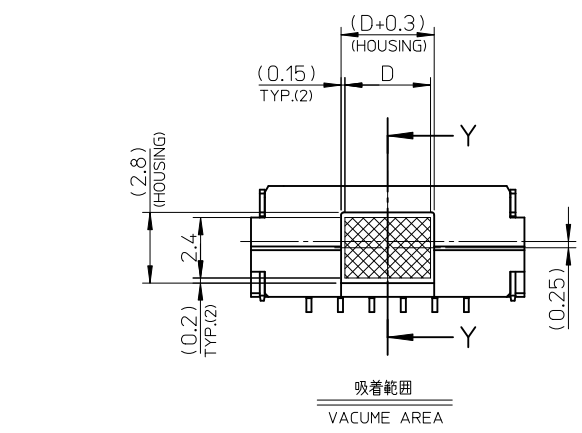

REVISED EC NO.: J2010-2320 DRWN: YG010 2010/05/19 CHK'D: K. ASAKAWA 2010/05/20 APPR: NUKITA 2010/05/21	GENERAL TOLERANCES (UNLESS SPECIFIED)		DIMENSION STYLE MM ONLY	SCALE 5:1	DESIGN UNITS METRIC	THIRD ANGLE PROJECTION
	10 UNDER	±0.2	DRAWN BY T. MIYAZAKI	DATE 2006/08/28	TITLE 1.25 W/B CONN. SINGLE R/A REC. ASS'Y 2-7CKT.	
	10 OVER 30 UNDER	±0.25	CHECKED BY K. ASAKAWA	DATE 2006/08/28	MOLEX INCORPORATED	
	30 OVER	±0.3	APPROVED BY Y.O. ITO	DATE 2006/08/28	MATERIAL NO. SEE TABLE	DOCUMENT NO. SD-502386-001
REV	DESCRIPTION	ANGULAR ±3 °	THIS DRAWING CONTAINS INFORMATION THAT IS PROPRIETARY TO MOLEX INCORPORATED AND SHOULD NOT BE USED WITHOUT WRITTEN PERMISSION			
		DRAFT WHERE APPLICABLE MUST REMAIN WITHIN DIMENSIONS				

WITH CAPTON TAPE										
HSG COLOR : GREEN		HSG COLOR : BLUE		HSG COLOR : RED		HSG COLOR : BLACK		HSG COLOR : NATURAL		
502386-0736	502386-**16	502386-0734	502386-**14	502386-0732	502386-**12	502386-0731	502386-**11	502386-0772	502386-**08	7
502386-0636		502386-0634		502386-0632		502386-0631		502386-0672		6
502386-0536		502386-0534		502386-0532		502386-0531		502386-0572		5
502386-0436		502386-0434		502386-0432		502386-0431		502386-0472		4
502386-0336		502386-0334		502386-0332		502386-0331		502386-0372		3
502386-0236		502386-0234		502386-0232		502386-0231		502386-0272		2
EMBOSSSED TAPE PACKAGE オーダー番号ORDER No.	コネクタ シリズ CONNECTOR SIRIES	EMBOSSSED TAPE PACKAGE オーダー番号ORDER No.	コネクタ シリズ CONNECTOR SIRIES	EMBOSSSED TAPE PACKAGE オーダー番号ORDER No.	コネクタ シリズ CONNECTOR SIRIES	EMBOSSSED TAPE PACKAGE オーダー番号ORDER No.	コネクタ シリズ CONNECTOR SIRIES	EMBOSSSED TAPE PACKAGE オーダー番号ORDER No.	コネクタ シリズ CONNECTOR SIRIES	極数 (KT. NO.)

WITHOUT CAPTON TAPE										
HSG COLOR : GREEN		HSG COLOR : BLUE		HSG COLOR : RED		HSG COLOR : BLACK		HSG COLOR : NATURAL		
502386-0746	502386-**26	502386-0744	502386-**24	502386-0742	502386-**22	502386-0741	502386-**21	502386-0770	502386-**09	7
502386-0646		502386-0644		502386-0642		502386-0641		502386-0670		6
502386-0546		502386-0544		502386-0542		502386-0541		502386-0570		5
502386-0446		502386-0444		502386-0442		502386-0441		502386-0470		4
502386-0346		502386-0344		502386-0342		502386-0341		502386-0370		3
502386-0246		502386-0244		502386-0242		502386-0241		502386-0270		2
EMBOSSSED TAPE PACKAGE オーダー番号ORDER No.	コネクタ シリズ CONNECTOR SIRIES	EMBOSSSED TAPE PACKAGE オーダー番号ORDER No.	コネクタ シリズ CONNECTOR SIRIES	EMBOSSSED TAPE PACKAGE オーダー番号ORDER No.	コネクタ シリズ CONNECTOR SIRIES	EMBOSSSED TAPE PACKAGE オーダー番号ORDER No.	コネクタ シリズ CONNECTOR SIRIES	EMBOSSSED TAPE PACKAGE オーダー番号ORDER No.	コネクタ シリズ CONNECTOR SIRIES	極数 (KT. NO.)

REVISED EC NO. J2010-2320 DRWN:YGGTO 2010/05/19 CHKD:K.ASAKAWA 2010/05/20 APPR:NUKITA 2010/05/21	GENERAL TOLERANCES (UNLESS SPECIFIED)		DIMENSION STYLE MM ONLY		SCALE ----	DESIGN UNITS METRIC	THIRD ANGLE PROJECTION	
	10 UNDER	±0.2	DRAWN BY DATE T.MIYAZAKI 2006/08/28		TITLE 1.25 W/B CONN. SINGLE R/A REC. ASS'Y 2-7CKT.			
	10 OVER 30 UNDER	±0.25	CHECKED BY DATE K.ASAKAWA 2006/08/28		APPROVED BY DATE YO.I TO 2006/08/28			
	30 OVER	±0.3	APPROVED BY DATE YO.I TO 2006/08/28		MATERIAL NO. DOCUMENT NO. SEE TABLE SD-502386-001			
	ANGULAR ±3 °	DRAFT WHERE APPLICABLE MUST REMAIN WITHIN DIMENSIONS		SIZE A3		SHEET NO. 3 OF 3		

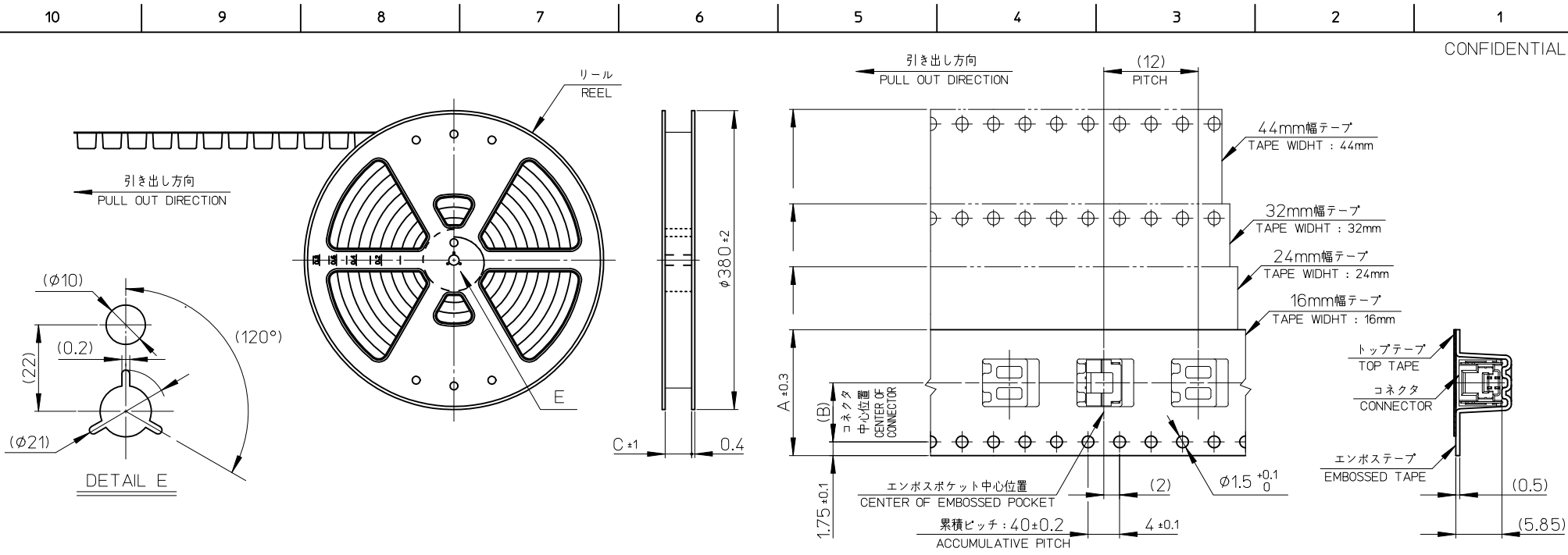

NOTES

- 製品詳細寸法については、SD-502386-001, -002 を参照下さい。  
PLEASE REFER TO SD-502386-001, -002 FOR THE DETAILED DIMENSION OF THE CONNECTOR.
- 梱包数量 : 1200個  
NUMBER OF CONNECTORS : 1200 PIECES/REEL.
- リードテープ長さ  
LEAD TAPE LENGTH

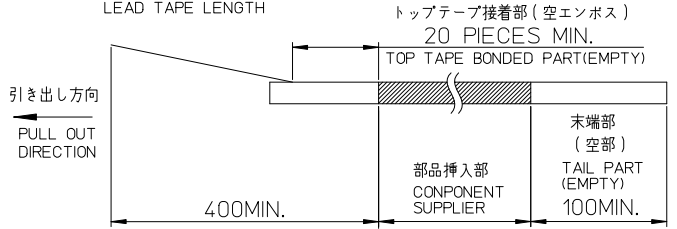

- 材料  
MATERIAL  
キャリアテープ : ポリスチレン  
CARRIER TAPE : POLYSTYRENE  
トップテープ : ポリエステル、ポリエチレン、ポリエチレンテレフタレート  
TOP TAPE : POLYESTER, POLYETHYLENE, POLYETHYLENE TEREPHTHALATE  
リール : ポリスチレン <リサイクル材を含む>  
REEL : POLYSTYRENE <RECYCLE MATERIAL CONTAINED>
- ELV 及び RoHS 適合品  
ELV AND ROHS COMPLIANT

45.5	20.2	44	502386-15**	15
45.5	20.2	44	502386-14**	14
33.5	14.2	32	502386-13**	13
33.5	14.2	32	502386-12**	12
33.5	14.2	32	502386-11**	11
33.5	14.2	32	502386-10**	10
25.5	11.5	24	502386-09**	9
25.5	11.5	24	502386-08**	8
25.5	11.5	24	502386-07**	7
25.5	11.5	24	502386-06**	6
25.5	11.5	24	502386-05**	5
25.5	11.5	24	502386-04**	4
17.5	7.5	16	502386-03**	3
17.5	7.5	16	502386-02**	2
C	B	エンボステープ幅 A WIDTH OF TAPE	製品番号 MATERIAL NO.	極数 EXT. NO.

REVISED EC NO: J2010-2024 DRWN: YGOTO 2010/04/07 CHKD: K. ASAKAWA 2010/04/12 APPR: NUKITA 2010/04/13	GENERAL TOLERANCES (UNLESS SPECIFIED)		DIMENSION STYLE MM ONLY		SCALE ---	DESIGN UNITS METRIC		THIRD ANGLE PROJECTION	
	10 UNDER	± 0.2	DRAWN BY T. MIYAZAKI	DATE 2006/10/16	TITLE 1.25 W/B CONN. SINGLE R/A REC. EMBTP PKG				
	10 OVER 30 UNDER	± 0.25	CHECKED BY K. ASAKAWA	DATE 2006/10/16	MATERIAL NO. DOCUMENT NO. SD-502386-003				
	30 OVER	± 0.3	APPROVED BY YO. ITO	DATE 2006/10/16	SHEET NO. 1 OF 2				
REV	DESCRIPTION	ANGULAR ± 3 °		SIZE A3		THIS DRAWING CONTAINS INFORMATION THAT IS PROPRIETARY TO MOLEX INCORPORATED AND SHOULD NOT BE USED WITHOUT WRITTEN PERMISSION			
		DRAFT WHERE APPLICABLE MUST REMAIN WITHIN DIMENSIONS							

WITH CAPTON TAPE										
HSG COLOR : GREEN		HSG COLOR : BLUE		HSG COLOR : RED		HSG COLOR : BLACK		HSG COLOR : NATURAL		
--/--	--/--	--/--	--/--	--/--	--/--	--/--	--/--	--/--	--/--	15
--/--	--/--	--/--	--/--	--/--	--/--	--/--	--/--	--/--	--/--	14
--/--	--/--	--/--	--/--	--/--	--/--	--/--	--/--	--/--	--/--	13
--/--	--/--	--/--	--/--	--/--	--/--	--/--	--/--	--/--	--/--	12
--/--	--/--	--/--	--/--	--/--	--/--	--/--	--/--	--/--	--/--	11
--/--	--/--	--/--	--/--	--/--	--/--	--/--	--/--	--/--	--/--	10
--/--	--/--	--/--	--/--	--/--	--/--	--/--	--/--	--/--	--/--	9
--/--	--/--	--/--	--/--	--/--	--/--	--/--	--/--	--/--	--/--	8
502386-**16	502386-0736	502386-**14	502386-0734	502386-**12	502386-0732	502386-**11	502386-0731	502386-**08	502386-0772	7
	502386-0636		502386-0634		502386-0632		502386-0631		502386-0672	6
	502386-0536		502386-0534		502386-0532		502386-0531		502386-0572	5
	502386-0436		502386-0434		502386-0432		502386-0431		502386-0472	4
	502386-0336		502386-0334		502386-0332		502386-0331		502386-0372	3
502386-0236	502386-0234	502386-0232	502386-0231	502386-0272	2					
コネクタ シリーズ CONNECTOR SERIES	製品番号 MATERIAL NO.	コネクタ シリーズ CONNECTOR SERIES	製品番号 MATERIAL NO.	コネクタ シリーズ CONNECTOR SERIES	製品番号 MATERIAL NO.	コネクタ シリーズ CONNECTOR SERIES	製品番号 MATERIAL NO.	コネクタ シリーズ CONNECTOR SERIES	製品番号 MATERIAL NO.	極数 (C.T. NO.)

WITHOUT CAPTON TAPE										
HSG COLOR : GREEN		HSG COLOR : BLUE		HSG COLOR : RED		HSG COLOR : BLACK		HSG COLOR : NATURAL		
502386-**26	502386-1546	502386-**24	502386-1544	502386-**22	502386-1542	502386-**21	502386-1541	502386-**09	502386-1570	15
	502386-1446		502386-1444		502386-1442		502386-1441		502386-1470	14
	502386-1346		502386-1344		502386-1342		502386-1341		502386-1370	13
	502386-1246		502386-1244		502386-1242		502386-1241		502386-1270	12
	502386-1146		502386-1144		502386-1142		502386-1141		502386-1170	11
	502386-1046		502386-1044		502386-1042		502386-1041		502386-1070	10
	502386-0946		502386-0944		502386-0942		502386-0941		502386-0970	9
	502386-0846		502386-0844		502386-0842		502386-0841		502386-0870	8
	502386-0746		502386-0744		502386-0742		502386-0741		502386-0770	7
	502386-0646		502386-0644		502386-0642		502386-0641		502386-0670	6
	502386-0546		502386-0544		502386-0542		502386-0541		502386-0570	5
	502386-0446		502386-0444		502386-0442		502386-0441		502386-0470	4
	502386-0346		502386-0344		502386-0342		502386-0341		502386-0370	3
	502386-0246		502386-0244		502386-0242		502386-0241		502386-0270	2
	コネクタ シリーズ CONNECTOR SERIES		製品番号 MATERIAL NO.		コネクタ シリーズ CONNECTOR SERIES		製品番号 MATERIAL NO.		コネクタ シリーズ CONNECTOR SERIES	製品番号 MATERIAL NO.

REVISED EC NO. J2010-2024 DRWN: YGOTO 2010/04/07 CH'KD: K. ASAKAWA 2010/04/12 APPR: NUKITA 2010/04/12	GENERAL TOLERANCES (UNLESS SPECIFIED)		DIMENSION STYLE MM ONLY		SCALE ---	DESIGN UNITS METRIC	THIRD ANGLE PROJECTION	
	10 UNDER	±0.2	DRAWN BY T. MIYAZAKI	DATE 2006/10/16	TITLE 1.25 W/B CONN. SINGLE R/A REC. EMBTP PKG			
	10 OVER 30 UNDER	±0.25	CHECKED BY K. ASAKAWA	DATE 2006/10/16	MOLEX INCORPORATED MATERIAL NO. SD-502386-003 DOCUMENT NO. 2 OF 2			
	30 OVER	±0.3	APPROVED BY Y. ITO	DATE 2006/10/16				
	ANGULAR ±3 °		DRAFT WHERE APPLICABLE MUST REMAIN WITHIN DIMENSIONS		SIZE A3		THIS DRAWING CONTAINS INFORMATION THAT IS PROPRIETARY TO MOLEX INCORPORATED AND SHOULD NOT BE USED WITHOUT WRITTEN PERMISSION	