



16-Bit DACs with 16-Channel Sample-and-Hold Outputs

MAX5621/MAX5622/MAX5623

General Description

The MAX5621/MAX5622/MAX5623 are 16-bit digital-to-analog converters (DACs) with 16 sample-and-hold (SHA) outputs for applications where a high number of programmable voltages are required. These devices include a clock oscillator and a sequencer that updates the DAC with codes from an internal SRAM. No external components are required to set offset and gain.

The MAX5621/MAX5622/MAX5623 feature a -4.5V to +9.2V output voltage range. Other features include a 200µV/step resolution, with output linearity error, typically 0.005% of full-scale range (FSR). The 100kHz refresh rate updates each SHA every 320µs, resulting in negligible output droop. Remote ground sensing allows the outputs to be referenced to the local ground of a separate device.

These devices are controlled through a 20MHz SPI™/QSPI™/MICROWIRE™-compatible 3-wire serial interface. Immediate update mode allows any channel's output to be updated within 20µs. Burst mode allows multiple values to be loaded into memory in a single, high-speed data burst. All channels are updated within 330µs after data has been loaded.

Each device features an output clamp and output resistors for filtering. The MAX5621 features a 50Ω output impedance and is capable of driving up to 250pF of output capacitance. The MAX5622 features a 500Ω output impedance and is capable of driving up to 10nF of output capacitance. The MAX5623 features a 1kΩ output impedance and is capable of driving up to 10nF of output capacitance.

The MAX5621/MAX5622/MAX5623 are available in 64-pin TQFP (12mm x 12mm) and 68-pin thin QFN (10mm x 10mm) packages.

Applications

- MEMS Mirror Servo Control
- Industrial Process Control
- Automatic Test Equipment
- Instrumentation

SPI and QSPI are trademarks of Motorola, Inc.
MICROWIRE is a trademark of National Semiconductor, Corp.

Features

- ◆ Integrated 16-Bit DAC and 16-Channel SHA with SRAM and Sequencer
- ◆ 16 Voltage Outputs
- ◆ 0.005% Output Linearity
- ◆ 200µV Output Resolution
- ◆ Flexible Output Voltage Range
- ◆ Remote Ground Sensing
- ◆ Fast Sequential Loading: 1.3µs per Register
- ◆ Burst and Immediate Mode Addressing
- ◆ No External Components Required for Setting Gain and Offset
- ◆ Integrated Output Clamp Diodes
- ◆ Three Output Impedance Options
MAX5621 (50Ω), MAX5622 (500Ω), and MAX5623 (1kΩ)

Ordering Information

PART	PIN-PACKAGE	PKG CODE
MAX5621UCB	64 TQFP	C64-8
MAX5621UTK	68 Thin QFN-EP*	T6800-3
MAX5622UCB	64 TQFP	C64-8
MAX5622UTK	68 Thin QFN-EP*	T6800-3
MAX5623UCB	64 TQFP	C64-8
MAX5623UTK	68 Thin QFN-EP*	T6800-3

*EP = Exposed pad.

Note: All devices specified over 0°C to +85°C operating range. For other temperature ranges, contact factory.

Pin Configurations

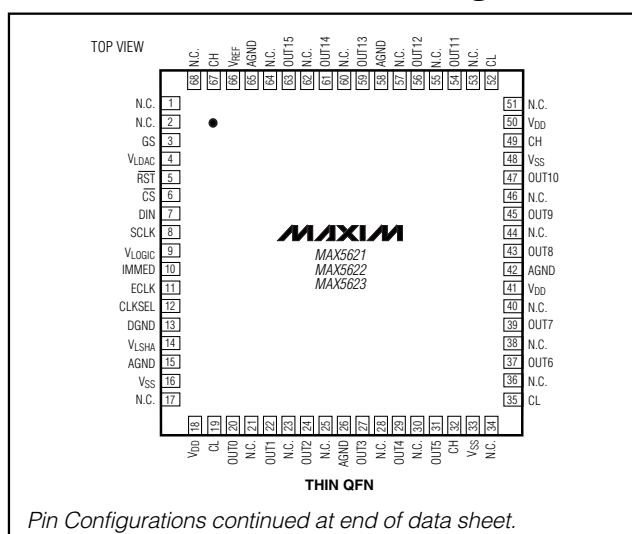

Pin Configurations continued at end of data sheet.



For pricing, delivery, and ordering information, please contact Maxim/Dallas Direct! at 1-888-629-4642, or visit Maxim's website at www.maxim-ic.com.

16-Bit DACs with 16-Channel Sample-and-Hold Outputs

ABSOLUTE MAXIMUM RATINGS

V _{DD} to AGND	-0.3V to +12.2V
V _{SS} to AGND	-6.0V to +0.3V
V _{DD} to V _{SS}	+15V
V _{LDAC} , V _{LOGIC} , V _{LSHA} to AGND or DGND	-0.3V to +6V
REF to AGND	-0.3V to +6V
GS to AGND	V _{SS} to V _{DD}
CL and CH to AGND	V _{SS} to V _{DD}
Logic Inputs to DGND	-0.3V to +6V
DGND to AGND	-0.3V to +2V
Maximum Current into OUT _n	±10mA

Maximum Current into Logic Inputs	±20mA
Continuous Power Dissipation (T _A = +70°C)	
64-Pin TQFP (derate 13.3mW/°C above +70°C)	1066mW
68-Pin Thin QFN (derate 28.6mW/°C above +70°C)	2285mW
Operating Temperature Range	0°C to +85°C
Maximum Junction Temperature	+150°C
Storage Temperature Range	-65°C to +150°C
Lead Temperature (soldering, 10s)	+300°C

Stresses beyond those listed under "Absolute Maximum Ratings" may cause permanent damage to the device. These are stress ratings only, and functional operation of the device at these or any other conditions beyond those indicated in the operational sections of the specifications is not implied. Exposure to absolute maximum rating conditions for extended periods may affect device reliability.

ELECTRICAL CHARACTERISTICS

(V_{DD} = +10V, V_{SS} = -4V, V_{LOGIC} = V_{LDAC} = V_{LSHA} = +5V, V_{REF} = +2.5V, AGND = DGND = V_{GS} = 0V, R_L ≥ 10MΩ, C_L = 50pF, CLKSEL = +5V, f_{ECLK} = 400kHz, T_A = T_{MIN} to T_{MAX}, unless otherwise noted. Typical values are at T_A = +25°C.)

PARAMETER	SYMBOL	CONDITIONS	MIN	TYP	MAX	UNITS
DC CHARACTERISTICS						
Resolution	N		16			Bits
Output Range	V _{OUT_n}	(Note 1)	V _{SS} + 0.75		V _{DD} - 2.4	V
Offset Voltage		Code = 4F2C hex		±15	±200	mV
Offset Voltage Tempco				±50		μV/°C
Gain Error		(Note 2)			±1	%
Gain Tempco				±5		ppm/°C
Integral Linearity Error	INL	V _{OUT_n} = -3.25V to +7.6V		0.005	0.015	%FSR
Differential Linearity Error	DNL	V _{OUT_n} = -3.25V to +7.6V; monotonicity guaranteed to 14 bits		±1	±4	LSB
Maximum Output Drive Current	I _{OUT}	Sinking and sourcing	±2			mA
DC Output Impedance	R _{OUT}	MAX5621	35	50	65	Ω
		MAX5622	350	500	650	
		MAX5623	700	1000	1300	
Maximum Capacitive Load		MAX5621		250		pF
		MAX5622		10		nF
		MAX5623		10		
DC Crosstalk		Internal oscillator enabled (Note 3)		-90		dB
Power-Supply Rejection Ratio	PSRR	Internal oscillator enabled		-80		dB

16-Bit DACs with 16-Channel Sample-and-Hold Outputs

MAX5621/MAX5622/MAX5623

ELECTRICAL CHARACTERISTICS (continued)

(V_{DD} = +10V, V_{SS} = -4V, V_{LOGIC} = V_{LDAC} = V_{LSHA} = +5V, V_{REF} = +2.5V, AGND = DGND = V_{GS} = 0V, R_L ≥ 10MΩ, C_L = 50pF, CLKSEL = +5V, f_{ECLK} = 400kHz, T_A = T_{MIN} to T_{MAX}, unless otherwise noted. Typical values are at T_A = +25°C.)

PARAMETER	SYMBOL	CONDITIONS	MIN	TYP	MAX	UNITS
DYNAMIC CHARACTERISTICS						
Sample-and-Hold Settling		(Note 4)			0.08	%
SCLK Feedthrough				0.5		nV-s
f _{SEQ} Feedthrough				0.5		nV-s
Hold-Step				0.25	1	mV
Droop Rate		V _{OUT_} = 0V (Note 5), T _A = +25°C		1	40	mV/s
Output Noise				250		μVRMS
REFERENCE INPUT						
Input Resistance			7			kΩ
Reference Input Voltage	V _{REF}			2.5		V
GROUND-SENSE INPUT						
Input Voltage Range	V _{GS}		-0.5		+0.5	V
Input Bias Current	I _{GS}	-0.5V ≤ V _{GS} ≤ +0.5V	-60		0	μA
GS Gain		(Note 6)	0.998	1	1.002	V/V
DIGITAL INTERFACE DC CHARACTERISTICS						
Input High Voltage	V _{IH}		2.0			V
Input Low Voltage	V _{IL}				0.8	V
Input Current					±1	μA
TIMING CHARACTERISTICS (Figure 2)						
Sequencer Clock Frequency	f _{SEQ}	Internal oscillator	80	100	120	kHz
External Clock Frequency	f _{ECLK}	(Note 7)			480	kHz
SCLK Frequency	f _{SCLK}				20	MHz
SCLK Pulse Width High	t _{CH}		15			ns
SCLK Pulse Width Low	t _{CL}		15			ns
$\overline{\text{CS}}$ Low to SCLK High Setup Time	t _{CSO}		15			ns
$\overline{\text{CS}}$ High to SCLK High Setup Time	t _{CS1}		15			ns
SCLK High to $\overline{\text{CS}}$ Low Hold Time	t _{CSH0}		10			ns

16-Bit DACs with 16-Channel Sample-and-Hold Outputs

ELECTRICAL CHARACTERISTICS (continued)

($V_{DD} = +10V$, $V_{SS} = -4V$, $V_{LOGIC} = V_{LDAC} = V_{LSHA} = +5V$, $V_{REF} = +2.5V$, $AGND = DGND = V_{GS} = 0V$, $R_L \geq 10M\Omega$, $C_L = 50pF$, $CLKSEL = +5V$, $f_{ECLK} = 400kHz$, $T_A = T_{MIN}$ to T_{MAX} , unless otherwise noted. Typical values are at $T_A = +25^\circ C$.)

PARAMETER	SYMBOL	CONDITIONS	MIN	TYP	MAX	UNITS
SCLK High to \overline{CS} High Hold Time	t_{CSH1}		0			ns
DIN to SCLK High Setup Time	t_{DS}		15			ns
DIN to SCLK High Hold Time	t_{DH}		0			ns
\overline{RST} to \overline{CS} Low		(Note 8)			500	μs
POWER SUPPLIES						
Positive Supply Voltage	V_{DD}	(Note 9)	8.55	10	11.60	V
Negative Supply Voltage	V_{SS}	(Note 9)	-5.25	-4	-2.75	V
Supply Difference		$V_{DD} - V_{SS}$ (Note 9)			14.5	V
Logic Supply Voltage	V_{LOGIC} , V_{LDAC} , V_{LSHA}		4.75	5	5.25	V
Positive Supply Current	I_{DD}			32	42	mA
Negative Supply Current	I_{SS}			32	40	mA
Logic Supply Current	I_{LOGIC}	(Note 10)		1	1.5	mA
		$f_{SCLK} = 20MHz$ (Note 11)		2	3	

Note 1: The nominal zero-scale (code = 0) voltage is -4.0535V. The nominal full-scale (code = FFFF hex) voltage is +9.0535V. The output voltage is limited by the Output Range specification, restricting the usable range of DAC codes. The nominal zero-scale voltage can be achieved when $V_{SS} < -4.9V$, and the nominal full-scale voltage can be achieved when $V_{DD} > +11.5V$.

Note 2: Gain is calculated from measurements:
for voltages $V_{DD} = 10V$ and $V_{SS} = -4V$ at codes C000 hex and 4F2C hex
for voltages $V_{DD} = 11.6V$ and $V_{SS} = -2.9V$ at codes FFFF hex and 252E hex
for voltages $V_{DD} = 9.25V$ and $V_{SS} = -5.25V$ at codes D4F6 hex and 0 hex
for voltages $V_{DD} = 8.55V$ and $V_{SS} = -2.75V$ at codes C74A hex and 281C hex

Note 3: Steady-state change in any output with an 8V change in an adjacent output.

Note 4: Settling during the first update for an 8V step. The output settles to within the linearity specification on subsequent updates. Tested with an external sequencer clock frequency of 480kHz.

Note 5: External clock mode with the external clock not toggling.

Note 6: The output voltage is the sum of the DAC output and the voltage at GS. GS gain is measured at 4F2C hex.

Note 7: The sequencer runs at $f_{SEQ} = f_{ECLK}/4$. Maximum speed is limited by settling of the DAC and SHAs. Minimum speed is limited by acceptable droop and update time after a Burst Mode Update.

Note 8: V_{DD} rise to \overline{CS} low = 500 μs maximum.

Note 9: Guaranteed by gain-error test.

Note 10: The serial interface is inactive. $V_{IH} = V_{LOGIC}$, $V_{IL} = 0V$.

Note 11: The serial interface is active. $V_{IH} = V_{LOGIC}$, $V_{IL} = 0V$.

16-Bit DACs with 16-Channel Sample-and-Hold Outputs

Typical Operating Characteristics

($V_{DD} = +10V$, $V_{SS} = -4V$, $V_{REF} = +2.5V$, $V_{GS} = 0V$, $T_A = +25^\circ C$, unless otherwise noted.)

MAX5621/MAX5622/MAX5623

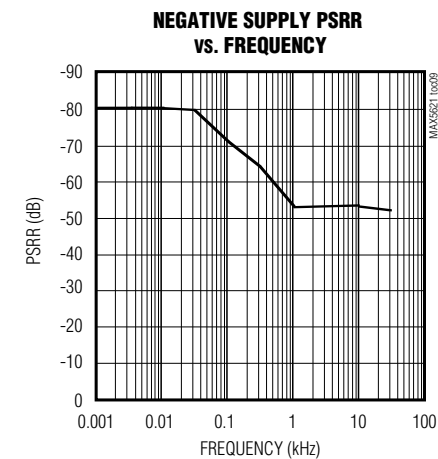
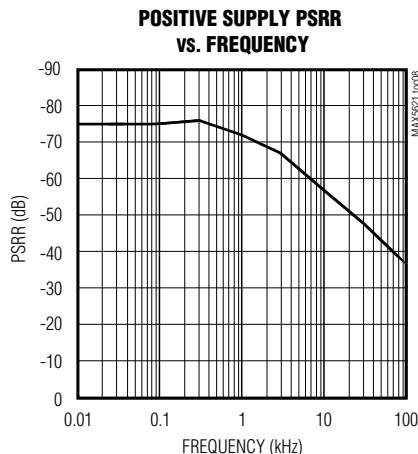
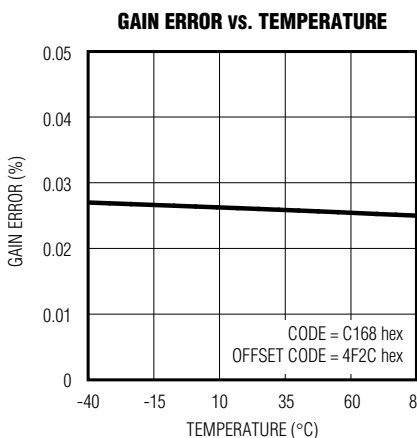
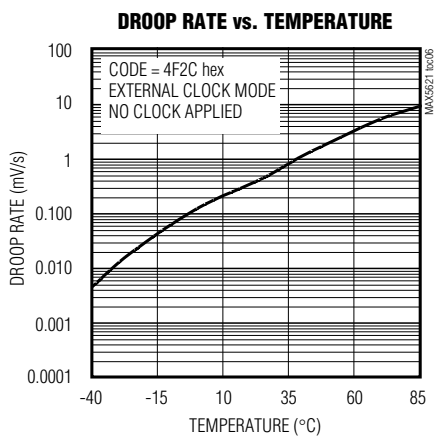
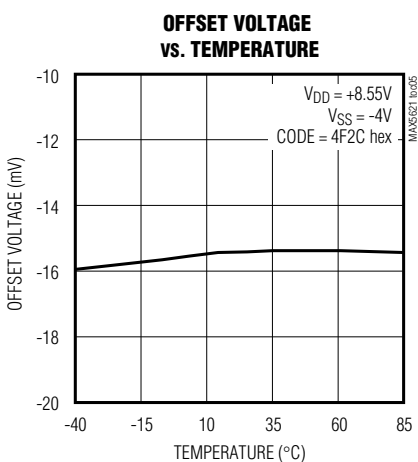
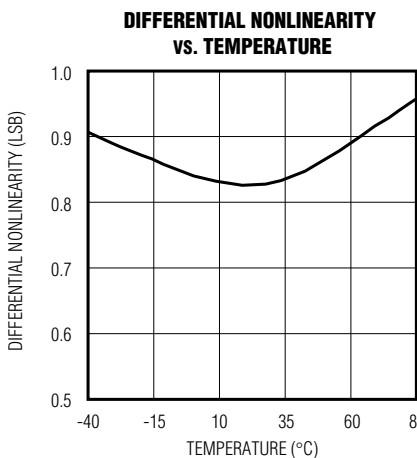
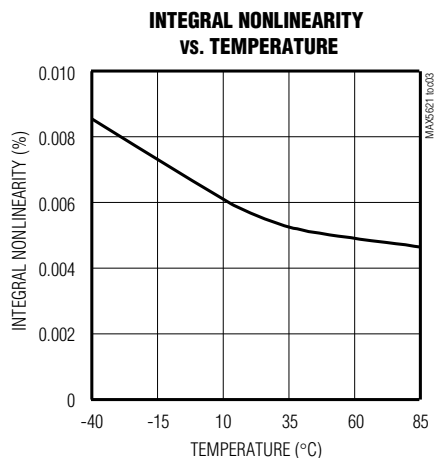
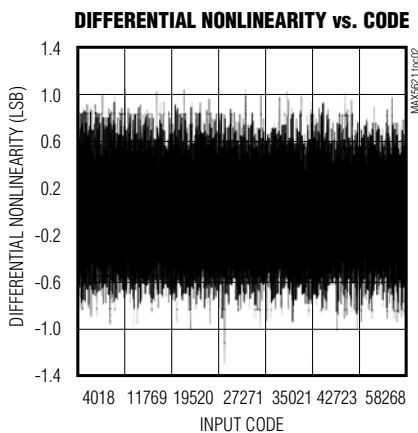
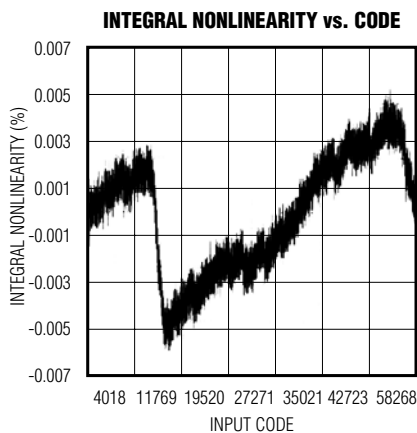

16-Bit DACs with 16-Channel Sample-and-Hold Outputs

Typical Operating Characteristics (continued)

($V_{DD} = +10V$, $V_{SS} = -4V$, $V_{REF} = +2.5V$, $V_{GS} = 0V$, $T_A = +25^\circ C$, unless otherwise noted.)

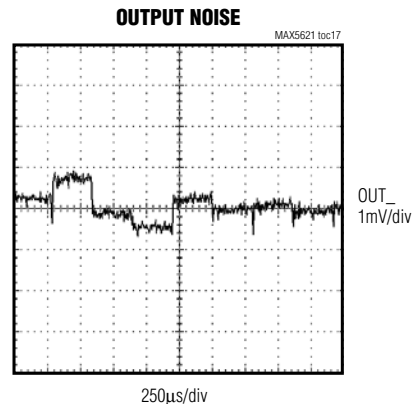
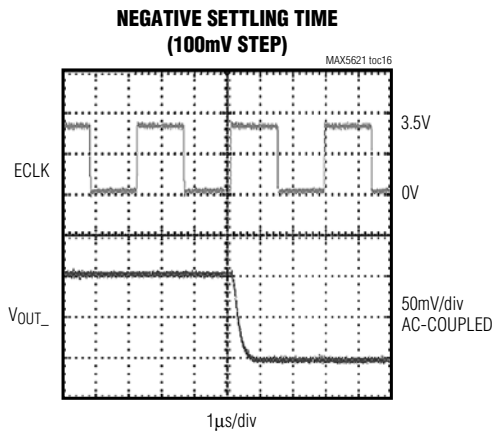
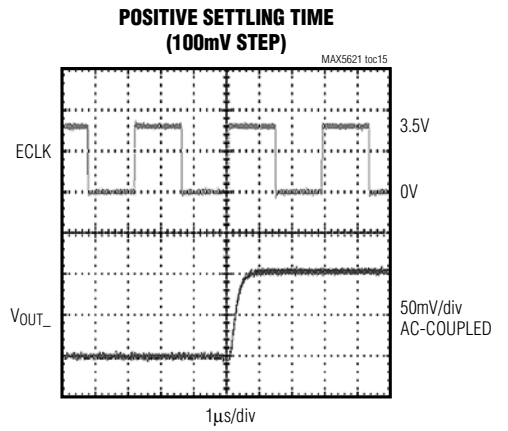
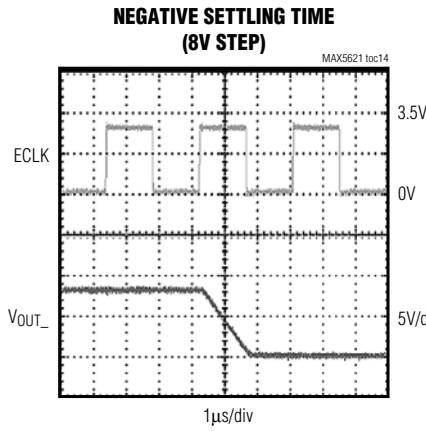
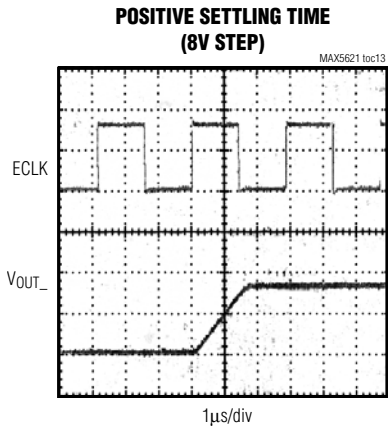
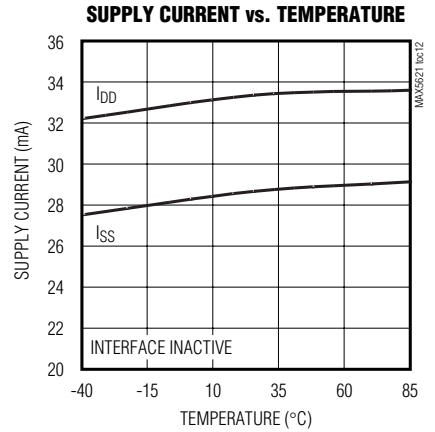
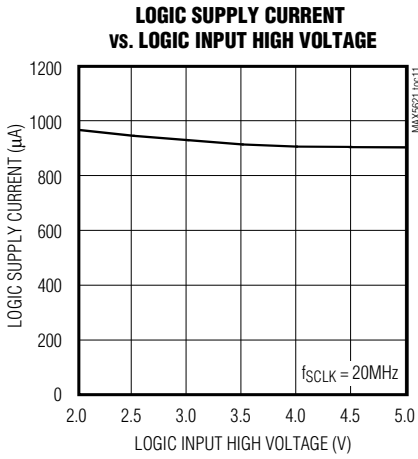
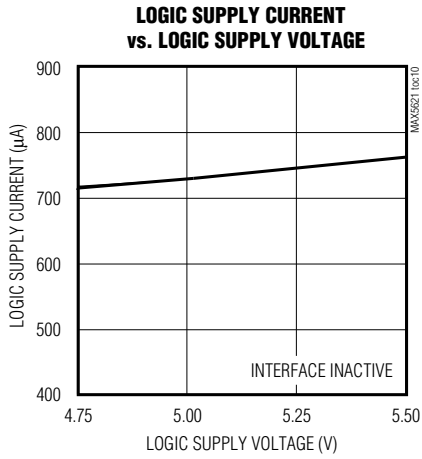

16-Bit DACs with 16-Channel Sample-and-Hold Outputs

Pin Description

MAX5621/MAX5622/MAX5623

PIN		NAME	FUNCTION
TQFP	THIN QFN		
1, 2, 20, 22, 24, 27, 29, 34, 36, 38, 42, 44, 50, 52, 54, 57, 59, 61	1, 2, 17, 21, 23, 25, 28, 30, 34, 36, 38, 40, 44, 46, 51, 53, 55, 57, 60, 62, 64, 68	N.C.	No Connection. Not internally connected.
3	3	GS	Ground-Sensing Input
4	4	VLDAC	+5V DAC Power Supply
5	5	$\overline{\text{RST}}$	Reset Input
6	6	$\overline{\text{CS}}$	Chip-Select Input
7	7	DIN	Serial Data Input
8	8	SCLK	Serial Clock Input
9	9	VLOGIC	+5V Logic Power Supply
10	10	IMMED	Immediate Update Mode
11	11	ECLK	External Sequencer Clock Input
12	12	CLKSEL	Clock-Select Input
13	13	DGND	Digital Ground
14	14	VLSHA	+5V Sample-and-Hold Power Supply
15, 25, 40, 55, 62	15, 26, 42, 58, 65	AGND	Analog Ground
16, 32, 46	16, 33, 48	VSS	Negative Power Supply
17, 39, 48	18, 41, 50	VDD	Positive Power Supply
18, 33, 49	19, 35, 52	CL	Output Clamp Low Voltage
19	20	OUT0	Output 0
21	22	OUT1	Output 1
23	24	OUT2	Output 2
26	27	OUT3	Output 3
28	29	OUT4	Output 4
30	31	OUT5	Output 5
35	37	OUT6	Output 6
37	39	OUT7	Output 7
41	43	OUT8	Output 8
43	45	OUT9	Output 9
45	47	OUT10	Output 10
31, 47, 64	32, 49, 67	CH	Output Clamp High Voltage
51	54	OUT11	Output 11
53	56	OUT12	Output 12
56	59	OUT13	Output 13
58	61	OUT14	Output 14
60	63	OUT15	Output 15
63	66	REF	Reference Voltage Input

16-Bit DACs with 16-Channel Sample-and-Hold Outputs

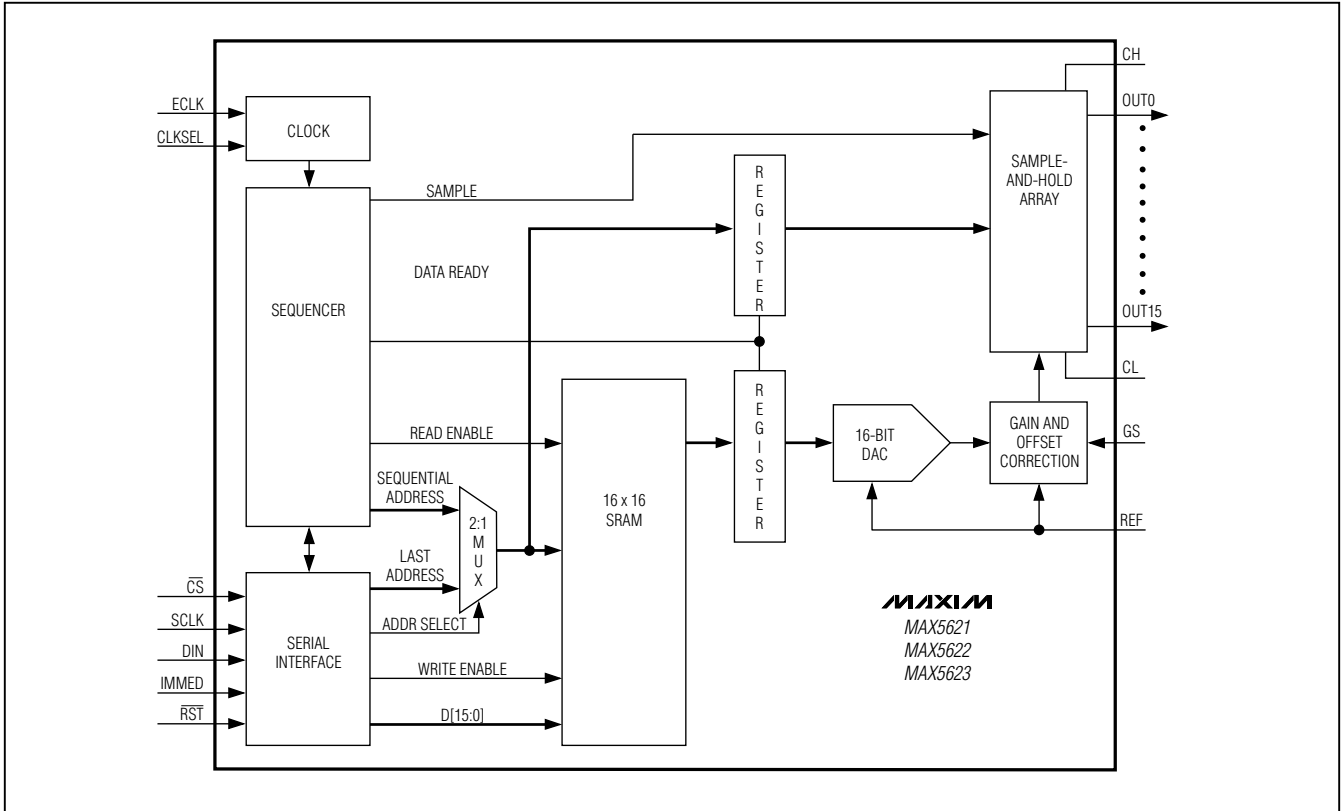

Figure 1. Functional Diagram

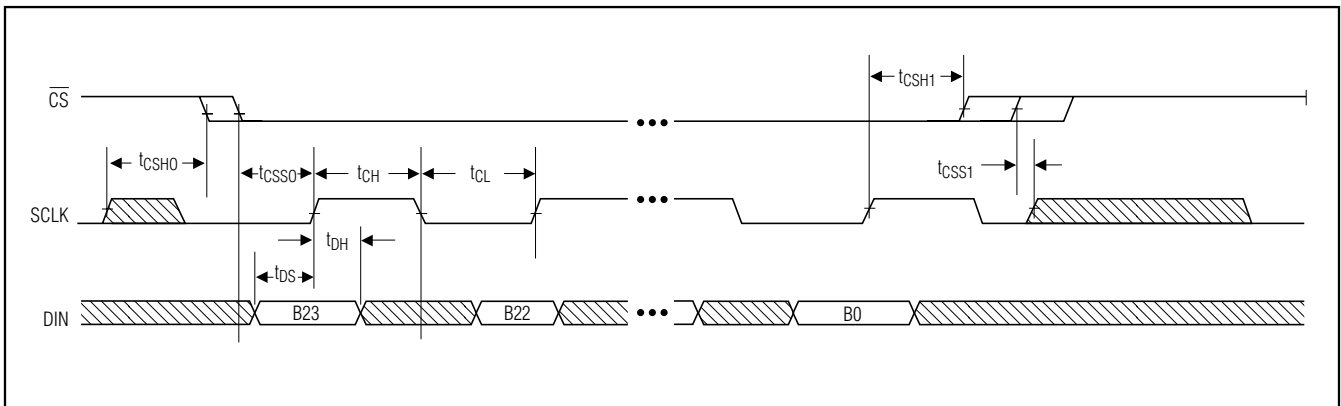

Figure 2. Serial Interface Timing Diagram

16-Bit DACs with 16-Channel Sample-and-Hold Outputs

Detailed Description

Digital-to-Analog Converter

The MAX5621/MAX5622/MAX5623 16-bit digital-to-analog converters (DACs) are composed of two matched sections. The four MSBs are derived through 15 identical matched resistors and the lower 12 bits are derived through a 12-bit inverted R-2R ladder.

Sample-and-Hold Amplifiers

The MAX5621/MAX5622/MAX5623 contain 16 buffered sample/hold circuits with internal hold capacitors. Internal hold capacitors minimize leakage current, dielectric absorption, feedthrough, and required board space. The MAX5621/MAX5622/MAX5623 provide a very low 1mV/s droop rate.

Output

The MAX5621/MAX5622/MAX5623 include output buffers on each channel. The device contains output resistors in series with the buffer output (Figure 3) for ease of output filtering and capacitive load driving stability.

Output loads increase the analog supply current (I_{DD} and I_{SS}). Excessively loading the outputs drastically increases power dissipation. Do not exceed the maximum power dissipation specified in the *Absolute Maximum Ratings*.

The maximum output voltage range depends on the analog supply voltages available and the output clamp voltages (see the *Output Clamp* section):

$$(V_{SS} + 0.75V) \leq V_{OUT_} \leq (V_{DD} - 2.4V)$$

The device has a fixed theoretical output range determined by the reference voltage, gain, and midscale offset. The output voltage for a given input code is calculated with the following:

$$V_{OUT} = \left(\frac{\text{code}}{65535} \right) \times V_{REF} \times 5.2428 - (1.6214 \times V_{REF}) + V_{GS}$$

where code is the decimal value of the DAC input code, V_{REF} is the reference voltage, and V_{GS} is the voltage at the ground-sense input. With a 2.5V reference, the nominal end points are -4.0535V and +9.0535V (Table 1). Note that these are “virtual” internal end-point voltages and cannot be reached with all combinations of negative and positive power-supply voltages. The nominal, usable DAC end-point codes for the selected power supplies can be calculated as:

$$\begin{aligned} \text{Lower end-point code} &= 32768 - ((2.5V - (V_{SS} + 0.75V)) / 200\mu V) \text{ (result } \geq 0) \\ \text{Upper end-point code} &= 32768 + ((V_{DD} - 2.4 - 2.5V) / 200\mu V) \text{ (result } \leq 65535) \end{aligned}$$

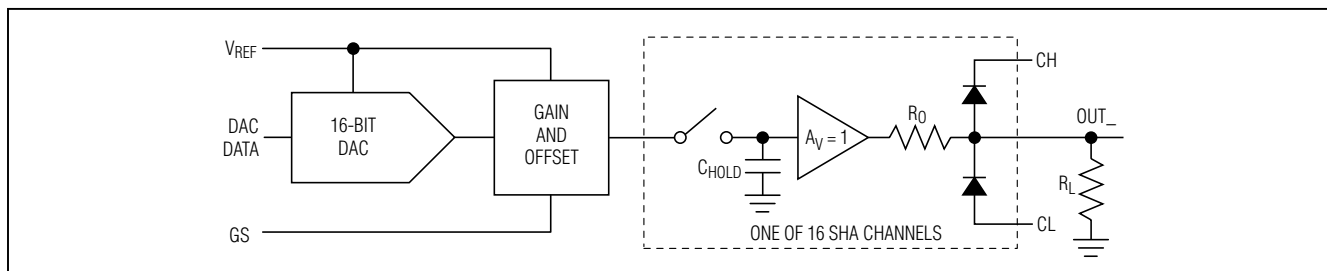

Figure 3. Analog Block Diagram

Table 1. Code Table

DAC INPUT CODE		NOMINAL OUTPUT VOLTAGE (V)	V _{REF} = +2.5V
MSB	LSB		
1111	1111 1111 1111	9.0535	Full-scale output
1100	0111 0100 1010	6.15	Maximum output with V _{DD} = 8.55V
1000	0000 0000 0000	2.5	Midscale output
0100	1111 0010 1100	0	V _{OUT_} = 0; all outputs default to this code after power-up
0010	1000 0001 1100	-2.0	Minimum output with V _{SS} = -2.75V
0000	0000 0000 0000	-4.0535	Zero-scale output

16-Bit DACs with 16-Channel Sample-and-Hold Outputs

The resistive voltage-divider formed by the output resistor (R_O) and the load impedance (R_L), scales the output voltage. Determine $V_{OUT_}$ as follows:

$$\text{Scaling Factor} = \frac{R_L}{R_L + R_O}$$

$$V_{OUT_} = V_{CHOLD} \times \text{scaling factor}$$

Ground Sense

The MAX5621/MAX5622/MAX5623 include a ground-sense input (GS), which allows the output voltages to be referenced to a remote ground. The voltage at GS is added to the output voltage with unity gain. Note that the resulting output voltage must be within the valid output voltage range set by the power supplies.

Output Clamp

The MAX5621/MAX5622/MAX5623 clamp the output between two externally applied voltages. Internal diodes at each channel restrict the output voltage to:

$$(V_{CH} + 0.7V) \geq V_{OUT_} \geq (V_{CL} - 0.7V)$$

The clamping diodes allow the MAX5621/MAX5622/MAX5623 to drive devices with restricted input ranges. The diodes also allow the outputs to be clamped during power-up or fault conditions. To disable output clamping, connect CH to V_{DD} and CL to V_{SS} , setting the clamping voltages beyond the maximum output voltage range.

Serial Interface

The MAX5621/MAX5622/MAX5623 are controlled by an SPI/QSPI/MICROWIRE-compatible 3-wire interface. Serial data is clocked into the 24-bit shift register in an MSB-first format, with the 16-bit DAC data preceding the 4-bit SRAM address, required zero bit, 2-bit control, and a fill 0 (Figure 4). The input word is framed by \overline{CS} . The first rising edge of SCLK after \overline{CS} goes low clocks in the MSB of the input word.

When each serial word is complete, the value is stored in the SRAM at the address indicated and the control bits are saved. Note that data can be corrupted if \overline{CS} is not held low for an integer multiple of 24 bits.

All of the digital inputs include Schmitt-trigger buffers to accept slow-transition interfaces. Their switching threshold is compatible with TTL and most CMOS logic levels.

Table 2. Channel/Output Selection

A3	A2	A1	A0	OUTPUT
0	0	0	0	OUT0 selected
0	0	0	1	OUT1 selected
0	0	1	0	OUT2 selected
0	0	1	1	OUT3 selected
0	1	0	0	OUT4 selected
0	1	0	1	OUT5 selected
0	1	1	0	OUT6 selected
0	1	1	1	OUT7 selected
1	0	0	0	OUT8 selected
1	0	0	1	OUT9 selected
1	0	1	0	OUT10 selected
1	0	1	1	OUT11 selected
1	1	0	0	OUT12 selected
1	1	0	1	OUT13 selected
1	1	1	0	OUT14 selected
1	1	1	1	OUT15 selected

Serial Input Data Format and Control Codes

The 24-bit serial input format, shown in Figure 4, comprises 16 data bits (D15–D0), 4 address bits (A3–A0), 1 required zero bit after the address bits, 2 control bits (C1, C0), and a fill zero. The address code selects the output channel as shown in Table 2. The control code configures the device as follows:

- 1) If C1 = 1, immediate update mode is selected. If C1 = 0, burst mode is selected.
- 2) If C0 = 0, the internal sequencer clock is selected. If C0 = 1, the external sequencer clock is selected. This must be repeated with each data word to maintain external input.

The operating modes can also be selected externally through CLKSEL and IMMED. In the case where the control bit in the serial word and the external signal conflict, the signal that is a logic 1 is dominant.

DATA																ADDRESS				CONTROL			
D15	D14	D13	D12	D11	D10	D09	D08	D07	D06	D05	D04	D03	D02	D01	D0	A3	A2	A1	A0	0	C1	C0	0
MSB																LSB							

Figure 4. Input Word Sequence

16-Bit DACs with 16-Channel Sample-and-Hold Outputs

Table 3. Update Mode

UPDATE MODE	UPDATE TIME
Immediate update mode	$2/f_{SEQ}$
Burst mode	$33/f_{SEQ}$

Modes of Operation

The MAX5621/MAX5622/MAX5623 feature three modes of operation:

- Sequence mode
- Immediate update mode
- Burst mode

Sequence Mode

Sequence mode is the default operating mode. The internal sequencer continuously scrolls through the SRAM, updating each of the 16 SHAs. At each SRAM address location, the stored 16-bit DAC code is loaded to the DAC. Once settled, the DAC output is acquired by the corresponding SHA. Using the internal sequencer clock, the process typically takes $320\mu\text{s}$ to update all 16 SHAs ($20\mu\text{s}$ per channel). Using an external sequencer clock the update process takes 128 clock cycles (eight clock cycles per channel).

Immediate Update Mode

Immediate update mode is used to change the contents of a single SRAM location, and update the corresponding SHA output. In immediate update mode, the selected output is updated before the sequencer resumes operation. Select immediate update mode by driving either IMMED or C1 high.

The sequencer is interrupted when \overline{CS} is taken low. The input word is then stored in the proper SRAM address. The DAC conversion and SHA sample in progress are completed transparent to the serial bus activity. The SRAM location of the addressed channel is then modified with the new data. The DAC and SHA are updated with the new voltage. The sequencer then resumes scrolling at the interrupted SRAM address.

This operation can take up to two cycles of the sequencer clock. Up to one cycle is needed to allow the sequencer to complete the operation in progress before it is freed to update the new channel. An additional cycle is required to read the new data from memory, update the DAC, and strobe the sample-and-hold. The sequencer resumes scrolling from the location at which it was interrupted. Normal sequencing is suppressed while loading data, thus preventing other channels from

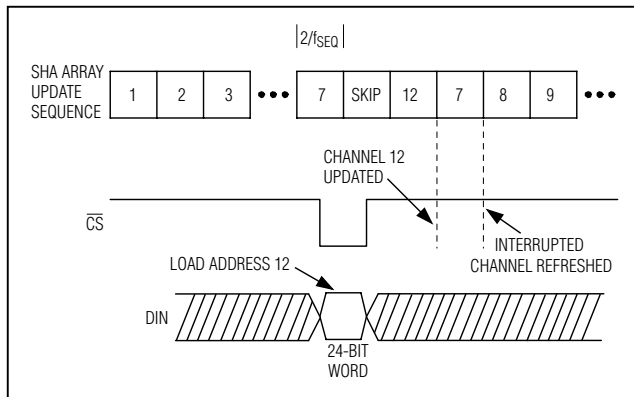

Figure 5. Immediate Update Mode Timing Example

being refreshed. Under conditions of extremely frequent immediate updates (i.e., 1000 successive updates), unacceptable droop can result.

Figure 5 shows an example of an immediate update operation. In this example, data for channel 12 is loaded while channel 7 is being refreshed. The sequencer operation is interrupted, and no other channels are refreshed as long as \overline{CS} is held low. Once \overline{CS} returns high, and the remainder of an f_{SEQ} period (if any) has expired, channel 12 is updated to the new data. Once channel 12 has been updated, the sequencer resumes normal operation at the interrupted channel 7.

Burst Mode

Burst mode allows multiple SRAM locations to be loaded at high speed. During burst mode, the output voltages are not updated until the data burst is complete and control returns to the sequencer. Select burst mode by driving both IMMED and C1 low.

The sequencer is interrupted when \overline{CS} is taken low. All or part of the memory can be loaded while \overline{CS} is low. Each data word is loaded into its specified SRAM address. The DAC conversion and SHA sample in progress are completely transparent to the serial bus activity. When \overline{CS} is taken high, the sequencer resumes scrolling at the interrupted SRAM address. New values are updated when their turn comes up in the sequence.

After burst mode is used, it is recommended that at least one full sequencer loop ($320\mu\text{s}$) is allowed to occur before the serial port is accessed again. This ensures that all outputs are updated before the sequencer is interrupted.

16-Bit DACs with 16-Channel Sample-and-Hold Outputs

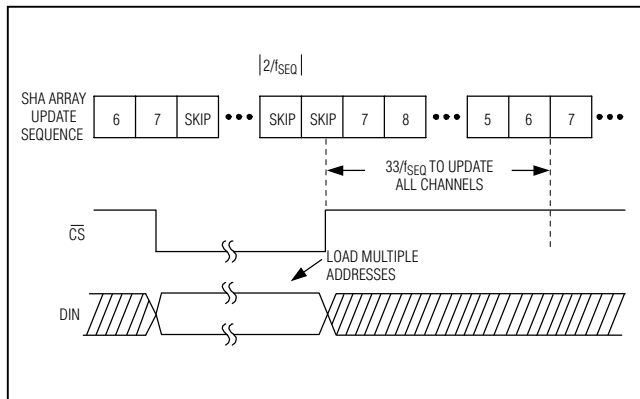

Figure 6. Burst Mode Timing Example

Figure 6 shows an example of a burst mode operation. As with the immediate update example, \overline{CS} falls while channel 7 is being refreshed. Data for multiple channels is loaded, and no channels are refreshed as long as \overline{CS} remains low. Once \overline{CS} returns high, sequencing resumes with channel 7 and continues normal refresh operation. Thirty-three fSEQ cycles are required before all channels have been updated.

External Sequencer Clock

An external clock can be used to control the sequencer, altering the output update rate. The sequencer runs at 1/4 the frequency of the supplied clock (ECLK). The external clock option is selected by driving either C0 or CLKSEL high.

When CLKSEL is asserted, the internal clock oscillator is disabled. This feature allows synchronizing the sequencer to other system operations, or shutting down of the sequencer altogether during high-accuracy system measurements. The low 1mV/s droop of these devices ensures that no appreciable degradation of the output voltages occurs, even during extended periods of time when the sequencer is disabled.

Power-On Reset

A power-on reset (POR) circuit sets all channels to 0V (code 4F2C hex) in sequence, requiring 320 μ s. This prevents damage to downstream ICs due to arbitrary reference levels being presented following system power-up. This same function is available by driving RST low. During the reset operation, the sequencer is run by the internal clock, regardless of the state of CLKSEL. The reset process cannot be interrupted, and serial inputs are ignored until the entire reset process is complete.

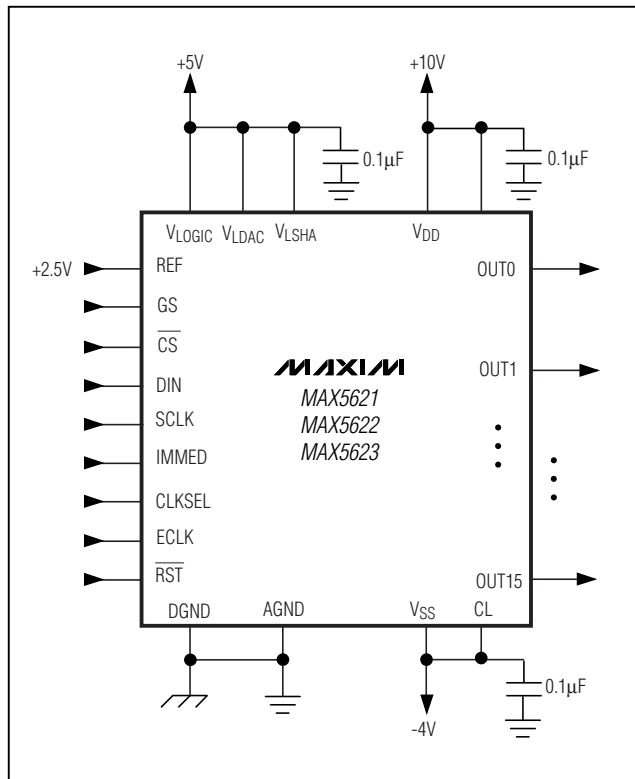

Figure 7. Typical Operating Circuit

Applications Information

Power Supplies and Bypassing

Grounding and power-supply decoupling strongly influence device performance. Digital signals may couple through the reference input, power supplies, and ground connection. Proper grounding and layout can reduce digital feedthrough and crosstalk. At the device level, a 0.1 μ F capacitor is required for the VDD, VSS, and VL_ pins. They should be placed as close to the pins as possible. More substantial decoupling at the board level is recommended and is dependent on the number of devices on the board (Figure 7).

The MAX5621/MAX5622/MAX5623 have three separate +5V logic power supplies, VLDAC, VLOGIC, and VLSHA. VLDAC powers the 16-bit digital-to-analog converter, VLSHA powers the control logic of the SHA array, and VLOGIC powers the serial interface, sequencer, internal clock and SRAM. Additional filtering of VLDAC and VLSHA improves the overall performance of the device.

16-Bit DACs with 16-Channel Sample-and-Hold Outputs

Pin Configurations (continued)

Chip Information

TRANSISTOR COUNT: 16,229
PROCESS: BiCMOS

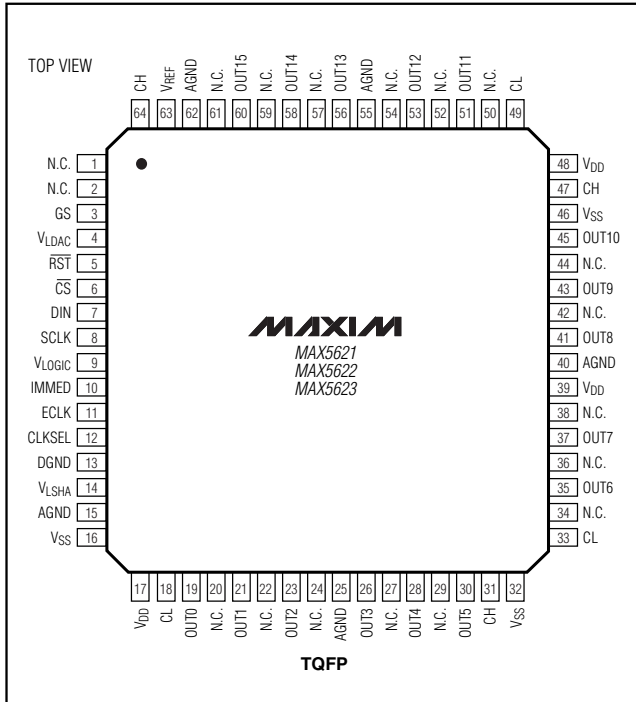

16-Bit DACs with 16-Channel Sample-and-Hold Outputs

Package Information

(The package drawing(s) in this data sheet may not reflect the most current specifications. For the latest package outline information go to www.maxim-ic.com/packages.)

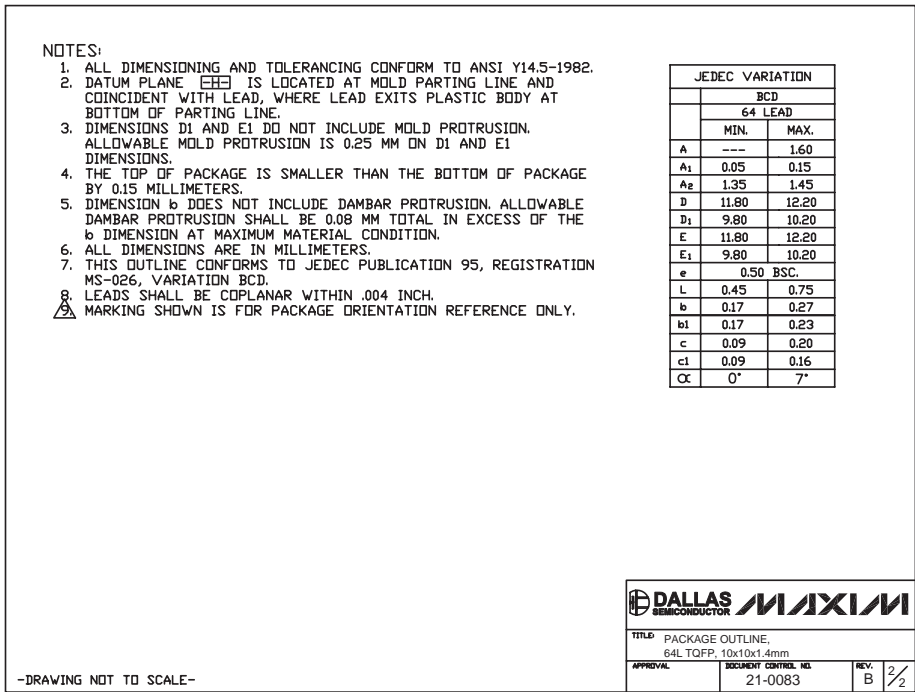
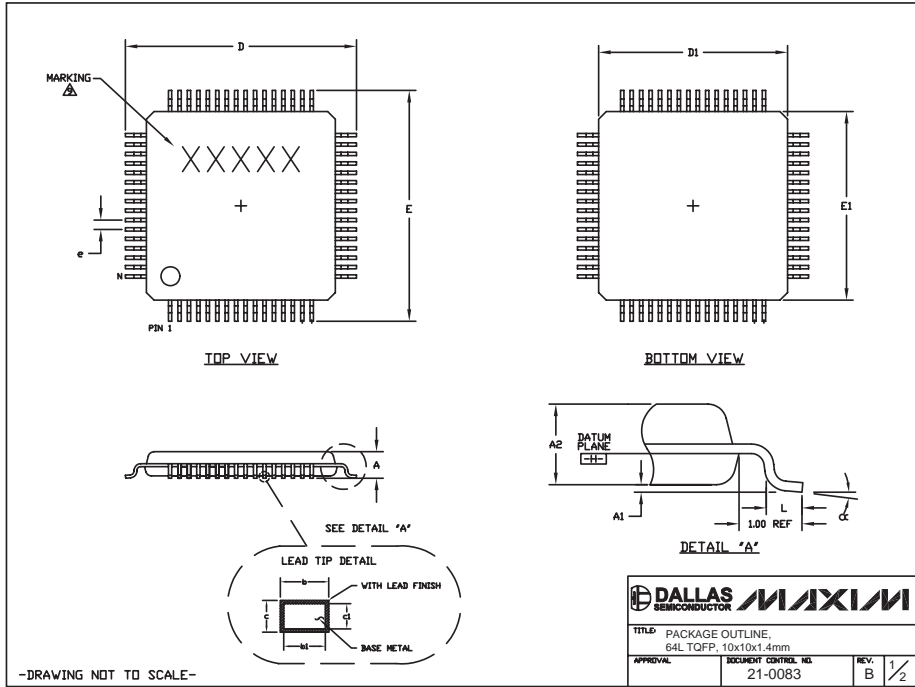

16-Bit DACs with 16-Channel Sample-and-Hold Outputs

Package Information (continued)

(The package drawing(s) in this data sheet may not reflect the most current specifications. For the latest package outline information go to www.maxim-ic.com/packages.)

MAX5621/MAX5622/MAX5623

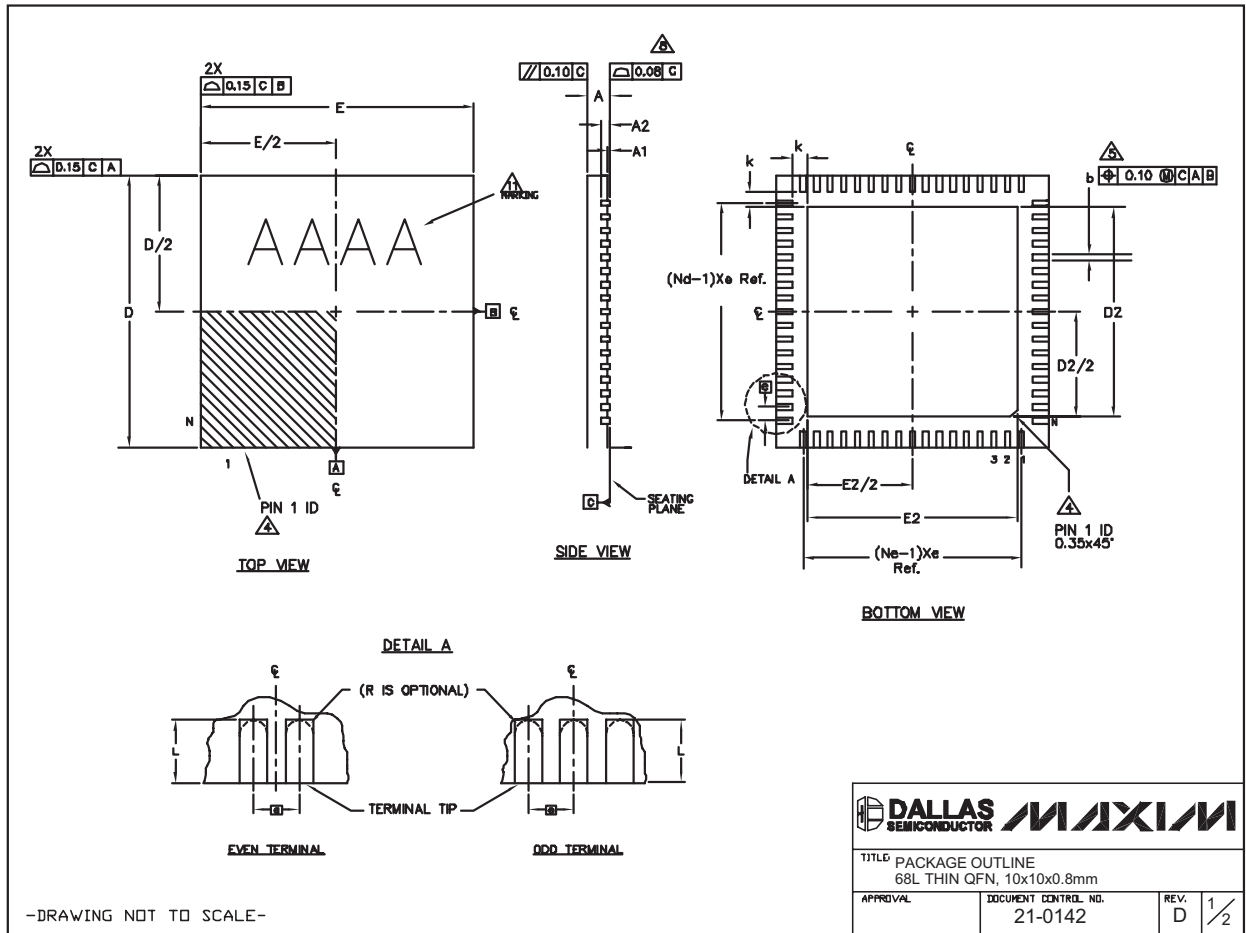

16-Bit DACs with 16-Channel Sample-and-Hold Outputs

Package Information (continued)

(The package drawing(s) in this data sheet may not reflect the most current specifications. For the latest package outline information go to www.maxim-ic.com/packages.)

PKG	68L 10x10			N D E
REF.	MIN.	NOM.	MAX.	
A	0.70	0.75	0.80	
A1	0.00	0.01	0.05	
A2	0.20 REF			
b	0.20	0.25	0.30	
D	9.90	10.00	10.10	
E	9.90	10.00	10.10	
e	0.50 BSC.			
k	0.25	-	-	
L	0.45	0.55	0.65	
N	68			
ND	17			
NE	17			
JEDEC	WNND-2			

PKG. CODE	D2			E2			DOWN BONDS ALLOWED
	MIN.	NOM.	MAX.	MIN.	NOM.	MAX.	
T6800-2	7.60	7.70	7.80	7.60	7.70	7.80	YES
T6800-3	7.60	7.70	7.80	7.60	7.70	7.80	NO
T6800-4	7.60	7.70	7.80	7.60	7.70	7.80	YES

NOTES:

1. DIMENSIONING & TOLERANCING CONFORM TO ASME Y14.5M-1994.
2. ALL DIMENSIONS ARE IN MILLIMETERS. ANGLES ARE IN DEGREES.
3. N IS THE TOTAL NUMBER OF TERMINALS.
4. THE TERMINAL #1 IDENTIFIER AND TERMINAL NUMBERING CONVENTION SHALL CONFORM TO JEDEC 95-1 SPP-012. DETAILS OF TERMINAL #1 IDENTIFIER ARE OPTIONAL, BUT MUST BE LOCATED WITHIN THE ZONE INDICATED. THE TERMINAL #1 IDENTIFIER MAY BE EITHER A MOLD OR MARKED FEATURE.
5. DIMENSION b APPLIES TO METALLIZED TERMINAL AND IS MEASURED BETWEEN 0.25mm AND 0.30mm FROM TERMINAL TIP.
6. ND AND NE REFER TO THE NUMBER OF TERMINALS ON EACH D AND E SIDE RESPECTIVELY.
7. DEPOPULATION IS POSSIBLE IN A SYMMETRICAL FASHION.
8. COPLANARITY APPLIES TO THE EXPOSED HEAT SINK SLUG AS WELL AS THE TERMINALS.
9. DRAWING CONFORMS TO JEDEC MO-220.
10. WARPAGE SHALL NOT EXCEED 0.10mm.
11. MARKING IS FOR PACKAGE ORIENTATION REFERENCE ONLY
12. NUMBER OF LEADS SHOWN ARE FOR REFERENCE ONLY

-DRAWING NOT TO SCALE-

	
TITLE PACKAGE OUTLINE 68L THIN QFN, 10x10x0.8mm	
APPROVAL	DOCUMENT CONTROL NO. 21-0142
REV. D	2/2

Maxim cannot assume responsibility for use of any circuitry other than circuitry entirely embodied in a Maxim product. No circuit patent licenses are implied. Maxim reserves the right to change the circuitry and specifications without notice at any time.

16 **Maxim Integrated Products, 120 San Gabriel Drive, Sunnyvale, CA 94086 408-737-7600**