

INTEGRATED MODULAR JACK

10/100 Base TX RJ45 Single Port Tab Down

Meets or exceeds IEEE 802.3 standard for 10/100 Base-TX
 350 uH minimum OCL with 8mA bias current
 Available with or without LEDs
 Minimum 1500Vrms isolation per IEEE802.3 requirement
 Operating temperature 0°C to +70°C
 Storage temperature -40°C to +85°C

Patent No.:

Taiwan - M243821, file94221170
 China - ZL03252694.6
 U.S.A. - 6,811,442 B1
 Japan - 3118754
 Germany - 20 2005 016 971.4

TRANSFORMER ELECTRICAL SPECIFICATIONS AT 25°C

Part Number	Turns Ratio		EMI Fingers	LEDs (L/R)	Insertion Loss (dB max.)	Return Loss 100Ω±15Ω (dB min.)			Cross talk (dB min.)			C.M.R. (dB min.)		Hi - po (Vrms 60Hz/1mi
	TX	RX				1-100 MHz	1-30 MHz	30-60 MHz	60-80 MHz	1-30 MHz	30-60 MHz	60-100 MHz	1-60 MHz	
M22DX-008110A	1CT:1CT	1CT:1CT	NO	N / A	-1	-18	-16	-12	-40	-35	-30	-40	-30	1500
M22DS-008111A	1CT:1CT	1CT:1CT	YES	G / Y	-1	-18	-16	-12	-40	-35	-30	-40	-30	1500
M22DS-008112A	1CT:1CT	1CT:1CT	YES	G / G	-1	-18	-16	-12	-40	-35	-30	-40	-30	1500
M22DS-008113A	1CT:1CT	1CT:1CT	YES	Y / G	-1	-18	-16	-12	-40	-35	-30	-40	-30	1500
M22DX-008120A	1CT:1CT	1CT:1CT	NO	N / A	-1	-18	-16	-12	-40	-35	-30	-40	-30	1500
M22DS-008121A	1CT:1CT	1CT:1CT	YES	G / Y	-1	-18	-16	-12	-40	-35	-30	-40	-30	1500
M22DS-008122A	1CT:1CT	1CT:1CT	YES	G / G	-1	-18	-16	-12	-40	-35	-30	-40	-30	1500
M22DS-008123A	1CT:1CT	1CT:1CT	YES	Y / G	-1	-18	-16	-12	-40	-35	-30	-40	-30	1500
M22DX-008260A	1CT:1CT	1CT:1CT	NO	N / A	-1	-18	-16	-12	-40	-35	-30	-40	-30	1500
M22DS-008261A	1CT:1CT	1CT:1CT	YES	G / Y	-1	-18	-16	-12	-40	-35	-30	-40	-30	1500
M22DS-008262A	1CT:1CT	1CT:1CT	YES	G / G	-1	-18	-16	-12	-40	-35	-30	-40	-30	1500
M22DS-008263A	1CT:1CT	1CT:1CT	YES	Y / G	-1	-18	-16	-12	-40	-35	-30	-40	-30	1500

NOTES : 1. LEDs Left / Right G=green, Y=yellow, N/A=none
 2. C.M.R. = Common Mode Rejection

MATERIAL SPECIFICATION

Metal Shell : Copper Alloy , Finish: 50u" Nickel
 Housing : Thermoplastic , UL 94V-0, Color Black
 Insert : Thermoplastic , UL 94V-0, Color Black
 Contact Terminal / Phosphor Bronze
 15u" Gold on Contact Area, 100u" Tin on Solder, Both over 50u" Nickel Under-Plated
 Coil Base : Phenolic , UL 94V-0, Color Black
 Terminal / Copper Alloy t=0.40x0.40mm Thickness



RoHS Compliant

NOTE : Specifications subject to change without notice. Please check our website for latest information.

12.05.2008



SUPERWORLD ELECTRONICS (S) PTE LTD

PG. 1

INTEGRATED MODULAR JACK

10/100 Base TX RJ45 Single Port Tab Down

MECHANICAL

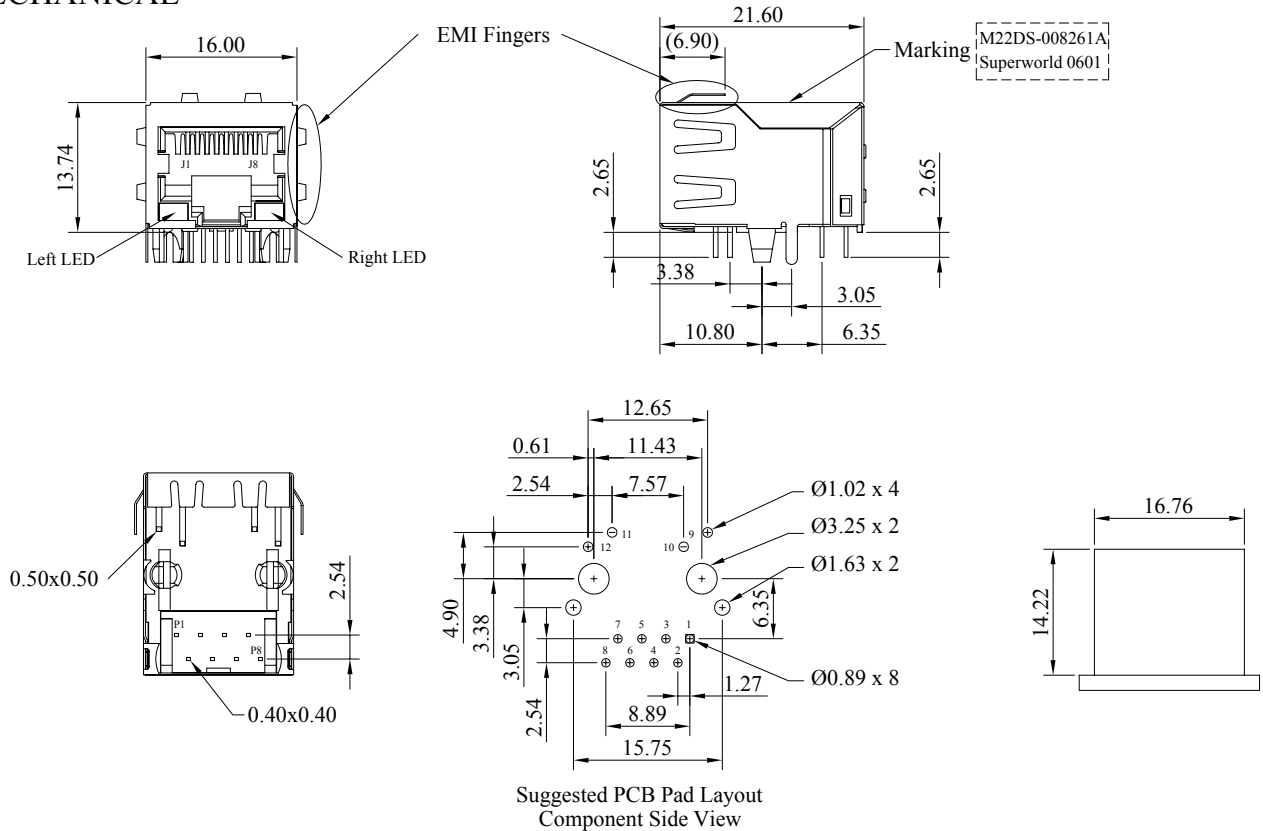

- NOTES : 1. Tolerance : PCB ±0.05mm
 Connector ±0.25mm
 2. Connector dimensions comply with FCC 68.5 dimension requirements

NOTE : Specifications subject to change without notice. Please check our website for latest information.



RoHS Compliant

12.05.2008



SUPERWORLD ELECTRONICS (S) PTE LTD

INTEGRATED MODULAR JACK

10/100 Base TX RJ45 Single Port Tab Down

SCHEMATIC

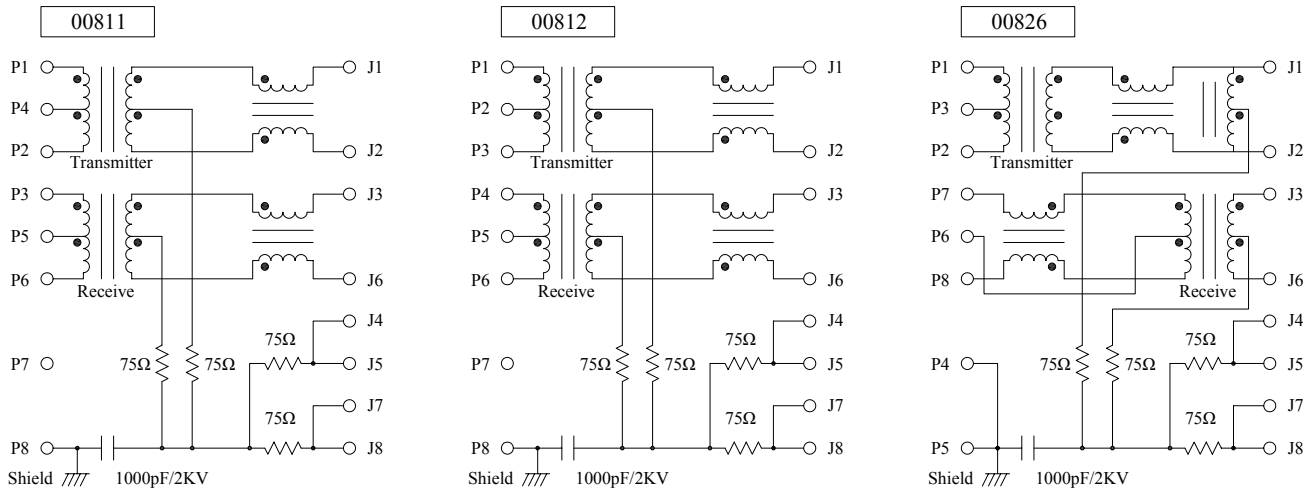

LED CONFIGURATION

Standard LED	Wavelength(λ)	V / IF=20mA	
		max.	typ.
Yellow	585nm	2.5 V	2.1 V
Green	570nm	2.5 V	2.1 V
Orange	605nm	2.5 V	2.1 V

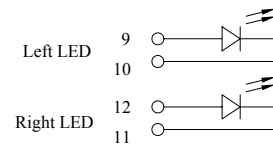

RoHS Compliant

NOTE : Specifications subject to change without notice. Please check our website for latest information.

12.05.2008



SUPERWORLD ELECTRONICS (S) PTE LTD