

## Optocoupler, Phototriac Output, High dV/dt, Low Input Current

### Features

- High input sensitivity  $I_{FT} = 2.0 \text{ mA}$
- 600/800 V blocking voltage
- 300 mA on-state current
- High static dV/dt 10 kV/ $\mu\text{s}$
- Inverse parallel SCRs provide commutating dV/dt > 10 kV/ $\mu\text{s}$
- Very low leakage < 10  $\mu\text{A}$
- Isolation Test Voltage 5300  $V_{RMS}$
- Small 6-pin DIP package
- Lead-free component
- Component in accordance to RoHS 2002/95/EC and WEEE 2002/96/EC

### Agency Approvals

- UL1577, File No. E52744 System Code H or J, Double Protection
- CSA -93751
- BABT/ BSI IEC60950 IEC60065
- DIN EN 60747-5-2 (VDE0884)  
DIN EN 60747-5-5 pending  
Available with Option 1

### Applications

Solid-state relays  
Industrial controls  
Office equipment  
Consumer appliances.

### Description

The IL420/ IL4208 consists of a GaAs IRLLED optically coupled to a photosensitive non-zero crossing TRIAC network. The TRIAC consists of two inverse parallel connected monolithic SCRs. These three semiconductors are assembled in a six pin dual in-line package.

High input sensitivity is achieved by using an emitter follower phototransistor and a cascaded SCR pre-driver resulting in an LED trigger current of less than 2.0 mA (DC)

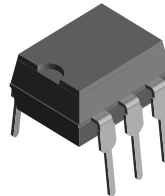

1179035

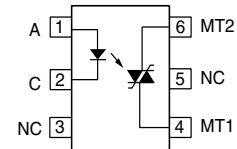

The IL420/ IL4208 used two discrete SCRs resulting in a commutating dV/dt of greater than 10 k/ $\mu\text{s}$ . The use of a proprietary dV/dt clam results in a static dV/dt of greater than 10 kV/ $\mu\text{s}$ . This clamp circuit has a MOSFET that is enhanced when high dV/dt spikes occur between MT1 and MT2 of the TRIAC. When conducting, the FET clamps the base of the phototransistors, disabling the first stage SCR pre-driver. The 600/800 V blocking voltage permits control of off-line voltages up to 240 VAC, with a safety factor of more than two, and is sufficient for as much as 380 VAC.

The IL420/ IL4208 isolates low-voltage logic from 120, 240, and 380 VAC lines to control resistive, inductive, or capacitive loads including motors, solenoids, high current thyristors or TRIAC and relays.

### Order Information

| Part        | Remarks                                    |
|-------------|--|
| IL420       | 600 V $V_{DRM}$ , DIP-6                    |
| IL4208      | 800 V $V_{DRM}$ , DIP-6                    |
| IL420-X006  | 600 V $V_{DRM}$ , DIP-6 400 mil (option 6) |
| IL420-X007  | 600 V $V_{DRM}$ , SMD-6 (option 7)         |
| IL420-X009  | 600 V $V_{DRM}$ , SMD-6 (option 9)         |
| IL4208-X007 | 800 V $V_{DRM}$ , SMD-6 (option 7)         |
| IL4208-X009 | 800 V $V_{DRM}$ , SMD-6 (option 9)         |

For additional information on the available options refer to Option Information.

### Absolute Maximum Ratings

$T_{amb} = 25\text{ }^{\circ}\text{C}$ , unless otherwise specified

Stresses in excess of the absolute Maximum Ratings can cause permanent damage to the device. Functional operation of the device is not implied at these or any other conditions in excess of those given in the operational sections of this document. Exposure to absolute Maximum Rating for extended periods of the time can adversely affect reliability.

### Input

| Parameter         | Test condition | Symbol     | Value | Unit  |
|-------------------|----------------|------------|-------|-------|
| Reverse voltage   |                | $V_R$      | 6.0   | V     |
| Forward current   |                | $I_F$      | 60    | mA    |
| Surge current     |                | $I_{FSM}$  | 2.5   | A     |
| Power dissipation |                | $P_{diss}$ | 100   | mW    |
| Derate from 25 °C |                |            | 1.33  | mW/°C |

### Output

| Parameter                  | Test condition | Part   | Symbol     | Value | Unit  |
|----------------------------|----------------|--------|------------|-------|-------|
| Peak off-state voltage     |                | IL420  | $V_{DRM}$  | 600   | V     |
|                            |                | IL4208 | $V_{DRM}$  | 800   | V     |
| RMS on-state current       |                |        | $I_{TM}$   | 300   | mA    |
| Single cycle surge current |                |        | $I_{TSM}$  | 3.0   | A     |
| Power dissipation          |                |        | $P_{diss}$ | 500   | mW    |
| Derate from 25 °C          |                |        |            | 6.6   | mW/°C |

### Coupler

| Parameter                            | Test condition  | Symbol    | Value          | Unit      |
|--------------------------------------|---|-----------|----------------|-----------|
| Isolation test voltage <sup>1)</sup> | $t = 1.0\text{ sec.}$   | $V_{ISO}$ | 5300           | $V_{RMS}$ |
| Pollution degree (DIN VDE 0109)      |   |           | 2              |           |
| Creepage distance                    |   |           | $\geq 7.0$     | mm        |
| Clearance                            |   |           | $\geq 7.0$     | mm        |
| Comparative tracking <sup>2)</sup>   |   |           | $\geq 175$     |           |
| Isolation resistance                 | $V_{IO} = 500\text{ V}, T_{amb} = 25\text{ }^{\circ}\text{C}$                     | $R_{IO}$  | $\geq 10^{12}$ | $\Omega$  |
|                                      | $V_{IO} = 500\text{ V}, T_{amb} = 100\text{ }^{\circ}\text{C}$                    | $R_{IO}$  | $\geq 10^{11}$ | $\Omega$  |
| Storage temperature range            |   | $T_{stg}$ | - 55 to + 150  | °C        |
| Ambient temperature range            |   | $T_{amb}$ | - 55 to + 100  | °C        |
| Soldering temperature                | max. $\leq 10\text{ sec.}$ dip soldering<br>$\geq 0.5\text{ mm}$ from case bottom | $T_{sld}$ | 260            | °C        |

<sup>1)</sup> between emitter and detector, climate per DIN 50014, part 2, Nov. 74

<sup>2)</sup> index per DIN IEC 60112/VDE 0303 part 1, group IIIa per DIN VDE 6110

### Electrical Characteristics

$T_{amb} = 25\text{ }^{\circ}\text{C}$ , unless otherwise specified

Minimum and maximum values are testing requirements. Typical values are characteristics of the device and are the result of engineering evaluation. Typical values are for information only and are not part of the testing requirements.

### Input

| Parameter                               | Test condition                            | Symbol     | Min | Typ. | Max  | Unit                 |
|---|---|------------|-----|------|------|----------------------|
| Forward voltage                         | $I_F = 10\text{ mA}$                      | $V_F$      |     | 1.16 | 1.35 | V                    |
| Reverse current                         | $V_R = 6.0\text{ V}$                      | $I_R$      |     | 0.1  | 10   | $\mu\text{A}$        |
| Input capacitance                       | $V_F = 0\text{ V}$ , $f = 1.0\text{ MHz}$ | $C_{IN}$   |     | 40   |      | pF                   |
| Thermal resistance, junction to ambient |   | $R_{thja}$ |     | 750  |      | $^{\circ}\text{C/W}$ |

### Output

| Parameter   | Test condition   | Part   | Symbol                     | Min   | Typ. | Max | Unit                           |
|---|--|--------|----------------------------|-------|------|-----|--------------------------------|
| Off-state voltage                                       | $I_{D(RMS)} = 70\text{ }\mu\text{A}$   | IL420  | $V_{D(RMS)}$               | 424   | 460  |     | V                              |
|   | $I_{D(RMS)} = 70\text{ }\mu\text{A}$   | IL4208 | $V_{D(RMS)}$               | 565   |      |     | V                              |
| Repetitive peak off-state voltage                       | $I_{DRM} = 100\text{ }\mu\text{s}$   | IL420  | $V_{DRM}$                  | 600   |      |     | V                              |
|   |  | IL4208 | $V_{DRM}$                  | 800   |      |     | V                              |
| Off-state current                                       | $V_D = V_{DRM}$ , $T_A = 100\text{ }^{\circ}\text{C}$  |        | $I_{BD}$                   |       | 10   | 100 | $\mu\text{A}$                  |
| On-state voltage  | $I_T = 300\text{ mA}$  |        | $V_{TM}$                   |       | 1.7  | 30  | V                              |
| On-current  | $PF = 1.0$ , $V_{T(RMS)} = 1.7\text{ V}$   |        | $I_{TM}$                   |       |      | 300 | mA                             |
| Surge (Non-repetitive) on-state current                 | $f = 50\text{ Hz}$   |        | $I_{TSM}$                  |       |      | 3.0 | A                              |
| Holding current   |  |        | $I_H$                      |       | 65   | 500 | $\mu\text{A}$                  |
| Latching current  | $V_T = 2.2\text{ V}$   |        | $I_L$                      |       | 5.0  |     | mA                             |
| LED trigger current                                     | $V_{AK} = 5.0\text{ V}$  |        | $I_{FT}$                   |       | 1.0  | 2.0 |                                |
| Trigger current temperature gradient                    |  |        | $\Delta I_{FT}/\Delta T_j$ |       | 7.0  | 14  | $\mu\text{A}/^{\circ}\text{C}$ |
| Critical state of rise off-state voltage                | $V_D = 0.67 V_{DRM}$ , $T_J = 25\text{ }^{\circ}\text{C}$  |        | $dV/dt_{cr}$               | 1000  |      |     | V/ $\mu\text{s}$               |
|   | $V_D = 0.67 V_{DRM}$ , $T_J = 80\text{ }^{\circ}\text{C}$  |        | $dV/dt_{cr}$               | 5000  |      |     | V/ $\mu\text{s}$               |
| Critical rate of rise of voltage at current commutation | $V_D = 0.67 V_{DRM}$ ,<br>$dI/dt_{crq} \leq 15\text{ A/ms}$ , $T_J = 25\text{ }^{\circ}\text{C}$ |        | $dV/dt_{crq}$              | 10000 |      |     | V/ $\mu\text{s}$               |
|   | $V_D = 0.67 V_{DRM}$ ,<br>$dI/dt_{crq} \leq 15\text{ A/ms}$ , $T_J = 80\text{ }^{\circ}\text{C}$ |        | $dV/dt_{crq}$              | 5000  |      |     | V/ $\mu\text{s}$               |
| Critical state of rise of on-state current              |  |        | $dI/dt_{cr}$               | 8.0   |      |     | A/ $\mu\text{s}$               |
| Thermal resistance, junction to ambient                 |  |        | $R_{thja}$                 |       | 150  |     | $^{\circ}\text{C/W}$           |

### Coupler

| Parameter   | Test condition                                       | Symbol   | Min       | Typ. | Max | Unit             |
|---|--|----------|-----------|------|-----|------------------|
| Critical rate of rise of coupled input/output voltage | $I_T = 0\text{ A}$ , $V_{RM} = V_{DM} = V_{D(RMS)}$  | $dV/dt$  |           | 500  |     | V/ $\mu\text{s}$ |
| Capacitance (input-output)                            | $f = 1.0\text{ MHz}$ , $V_{IO} = 0\text{ V}$         | $C_{IO}$ |           | 0.8  |     | pF               |
| Isolation resistance                                  | $V_{IO} = 500$ , $T_A = 25\text{ }^{\circ}\text{C}$  | $R_{IO}$ | $10^{12}$ |      |     | $\Omega$         |
|   | $V_{IO} = 500$ , $T_A = 100\text{ }^{\circ}\text{C}$ | $R_{IO}$ | $10^{11}$ |      |     | $\Omega$         |

### Switching Characteristics

| Parameter    | Test condition                 | Symbol    | Min | Typ. | Max | Unit    |
|--------------|--------------------------------|-----------|-----|------|-----|---------|
| Turn-on time | $V_{RM} = V_{DM} = V_{D(RMS)}$ | $t_{on}$  |     | 35   |     | $\mu s$ |
|              | PF = 1.0, $I_T = 300$ mA       | $t_{off}$ |     | 50   |     | $\mu s$ |

### Typical Characteristics ( $T_{amb} = 25^\circ C$ unless otherwise specified)

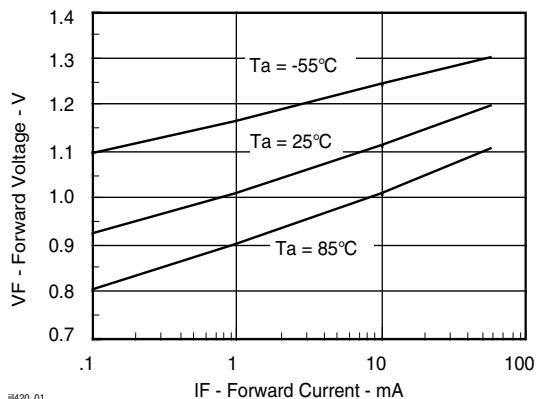

Figure 1. Forward Voltage vs. Forward Current

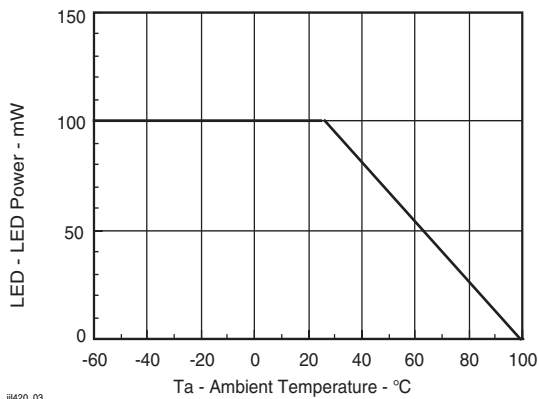

Figure 3. Maximum LED Power Dissipation

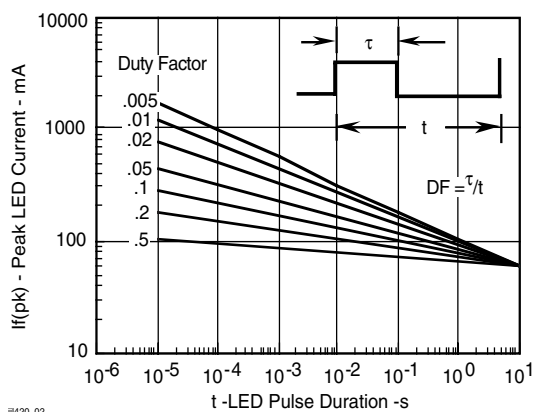

Figure 2. Peak LED Current vs. Duty Factor, Tau

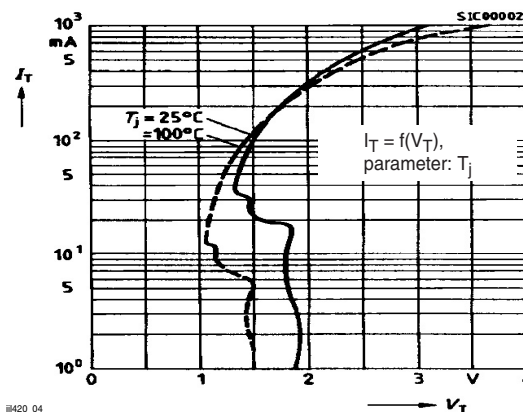

Figure 4. Typical Output Characteristics

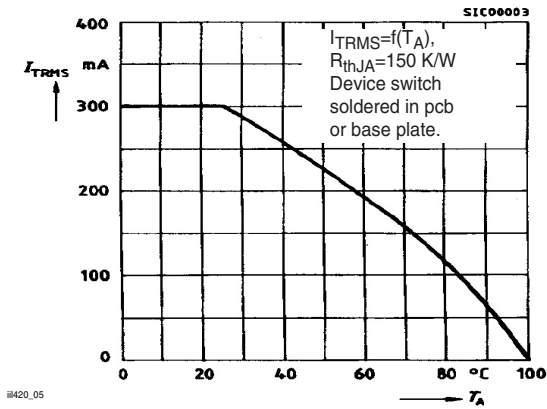

Figure 5. Current Reduction

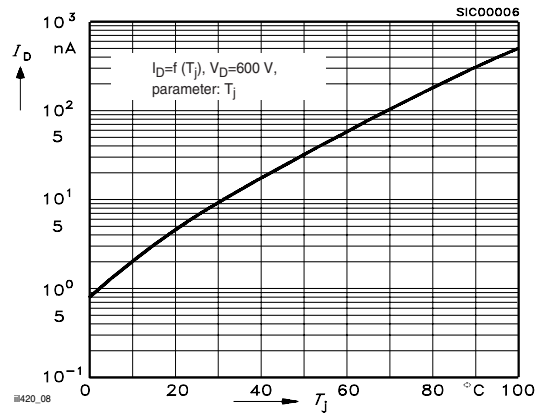

Figure 8. Typical Off-State Current

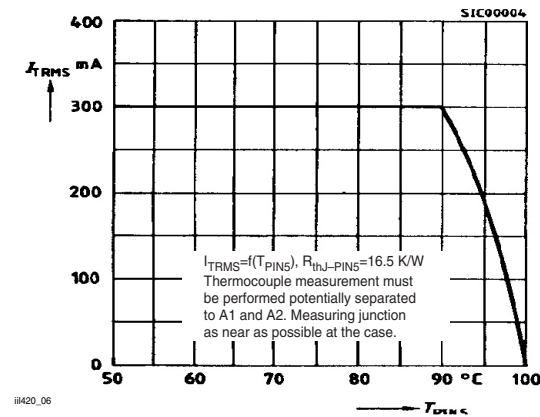

Figure 6. Current Reduction

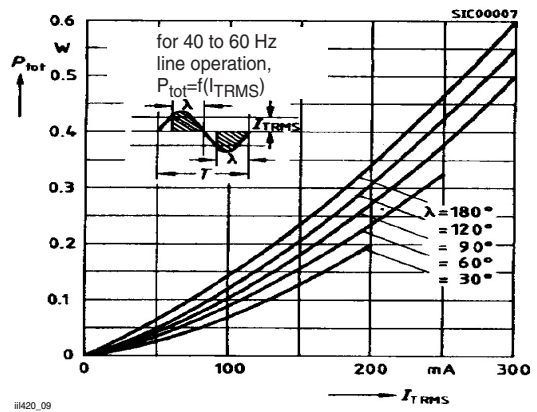

Figure 9. Power Dissipation

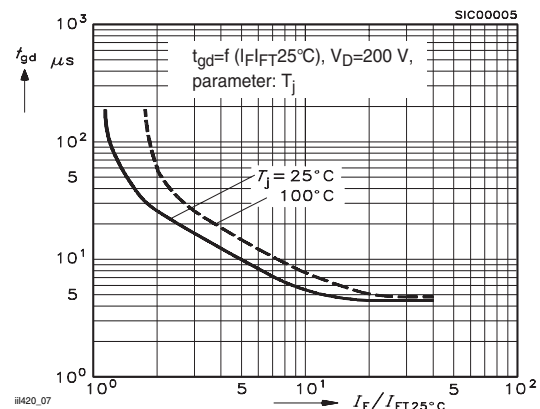

Figure 7. Typical Trigger Delay Time

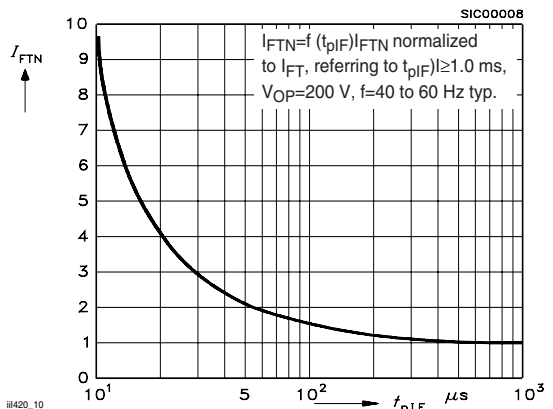
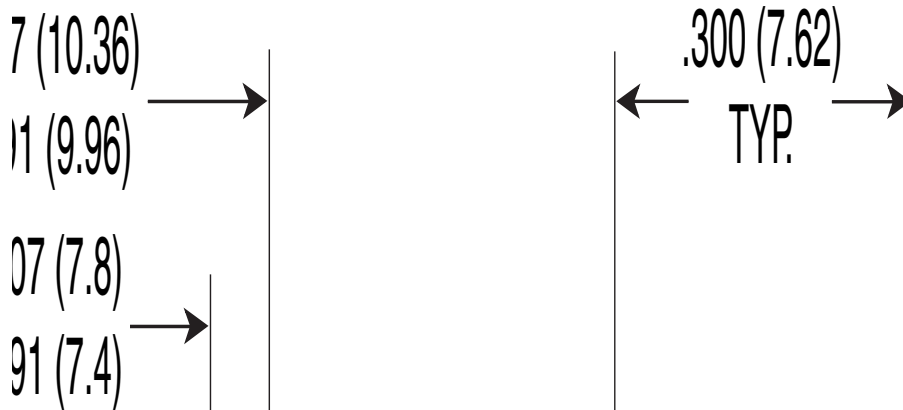
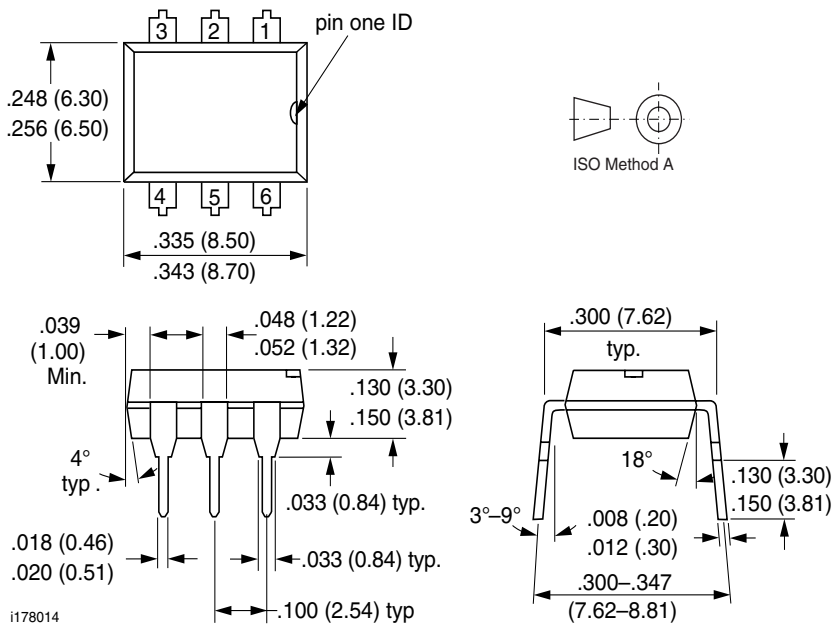

Figure 10. Pulse Trigger Current

## Package Dimensions in Inches (mm)





## Ozone Depleting Substances Policy Statement

It is the policy of Vishay Semiconductor GmbH to

1. Meet all present and future national and international statutory requirements.
2. Regularly and continuously improve the performance of our products, processes, distribution and operating systems with respect to their impact on the health and safety of our employees and the public, as well as their impact on the environment.

It is particular concern to control or eliminate releases of those substances into the atmosphere which are known as ozone depleting substances (ODSs).

The Montreal Protocol (1987) and its London Amendments (1990) intend to severely restrict the use of ODSs and forbid their use within the next ten years. Various national and international initiatives are pressing for an earlier ban on these substances.

Vishay Semiconductor GmbH has been able to use its policy of continuous improvements to eliminate the use of ODSs listed in the following documents.

1. Annex A, B and list of transitional substances of the Montreal Protocol and the London Amendments respectively
2. Class I and II ozone depleting substances in the Clean Air Act Amendments of 1990 by the Environmental Protection Agency (EPA) in the USA
3. Council Decision 88/540/EEC and 91/690/EEC Annex A, B and C (transitional substances) respectively.

Vishay Semiconductor GmbH can certify that our semiconductors are not manufactured with ozone depleting substances and do not contain such substances.

We reserve the right to make changes to improve technical design and may do so without further notice.

Parameters can vary in different applications. All operating parameters must be validated for each customer application by the customer. Should the buyer use Vishay Semiconductors products for any unintended or unauthorized application, the buyer shall indemnify Vishay Semiconductors against all claims, costs, damages, and expenses, arising out of, directly or indirectly, any claim of personal damage, injury or death associated with such unintended or unauthorized use.

Vishay Semiconductor GmbH, P.O.B. 3535, D-74025 Heilbronn, Germany  
Telephone: 49 (0)7131 67 2831, Fax number: 49 (0)7131 67 2423