

Features

- Very high speed: 45 ns
- Wide voltage range: 2.20 V to 3.60 V
- Pin compatible with CY62137CV30
- Ultra low standby power
 - Typical standby current: 1 μ A
 - Maximum standby current: 7 μ A
- Ultra low active power
 - Typical active current: 2 mA at f = 1 MHz
- Easy memory expansion with \overline{CE} and \overline{OE} features
- Automatic power-down when deselected
- Complementary metal oxide semiconductor (CMOS) for optimum speed and power
- Byte power-down feature
- Offered in Pb-free 48-ball very fine ball grid array (VFBGA) and 44-pin thin small outline package (TSOPII) package

Functional Description

The CY62137EV30⁽¹⁾ is a high performance CMOS static RAM organized as 128K words by 16 bits. This device features advanced circuit design to provide ultra low active current. This is ideal for providing More Battery Life™ (MoBL®) in portable applications such as cellular telephones. The device also has an automatic power down feature that significantly reduces power consumption by 90% when addresses are not toggling. The device can also be put into standby mode reducing power consumption when deselected (\overline{CE} HIGH or both \overline{BLE} and \overline{BHE} are HIGH). The input and output pins (I/O_0 through I/O_{15}) are placed in a high impedance state when: deselected (\overline{CE} HIGH), outputs are disabled (\overline{OE} HIGH), both Byte High Enable and Byte Low Enable are disabled (\overline{BHE} , \overline{BLE} HIGH), or during a write operation (\overline{CE} LOW and \overline{WE} LOW).

Writing to the device is accomplished by asserting Chip Enable (\overline{CE}) and Write Enable (\overline{WE}) inputs LOW. If Byte Low Enable (\overline{BLE}) is LOW, then data from I/O pins (I/O_0 through I/O_7), is written into the location specified on the address pins (A_0 through A_{16}). If Byte High Enable (\overline{BHE}) is LOW, then data from I/O pins (I/O_8 through I/O_{15}) is written into the location specified on the address pins (A_0 through A_{16}).

Reading from the device is accomplished by asserting Chip Enable (\overline{CE}) and Output Enable (\overline{OE}) LOW while forcing the Write Enable (\overline{WE}) HIGH. If Byte Low Enable (\overline{BLE}) is LOW, then data from the memory location specified by the address pins appears on I/O_0 to I/O_7 . If Byte High Enable (\overline{BHE}) is LOW, then data from memory appears on I/O_8 to I/O_{15} . See the [Truth Table](#) on page 10 for a complete description of read and write modes.

The CY62137EV30 is available in 48-ball VFBGA and 44-pin TSOPII packages.

Logic Block Diagram

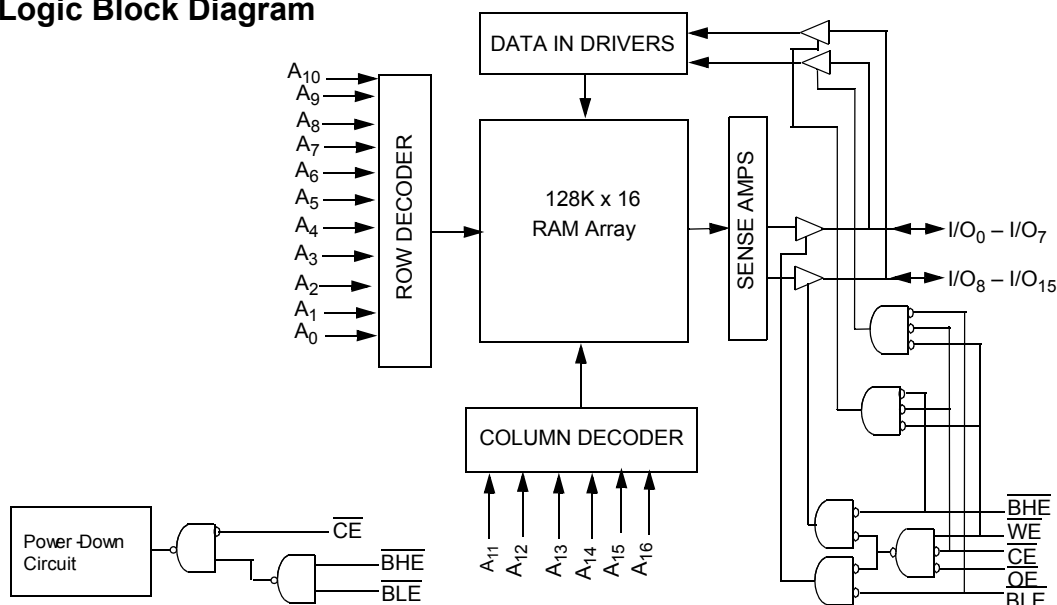

Note

1. For best practice recommendations, refer to the Cypress application note "SRAM System Design Guidelines" on <http://www.cypress.com>.

Contents

Pin Configurations	3	Ordering Information	11
Product Portfolio	3	Ordering Code Definition	11
Maximum Ratings	4	Package Diagrams	12
Operating Range	4	Acronyms	13
Electrical Characteristics	4	Document Conventions	13
Capacitance	5	Units of Measure	13
Thermal Resistance	5	Document History Page	14
Data Retention Characteristics	5	Sales, Solutions, and Legal Information	15
Data Retention Waveform	5	Worldwide Sales and Design Support	15
Switching Characteristics	6	Products	15
Switching Waveforms	7	PSoC Solutions	15
Truth Table	10		

Pin Configurations^[2, 3]

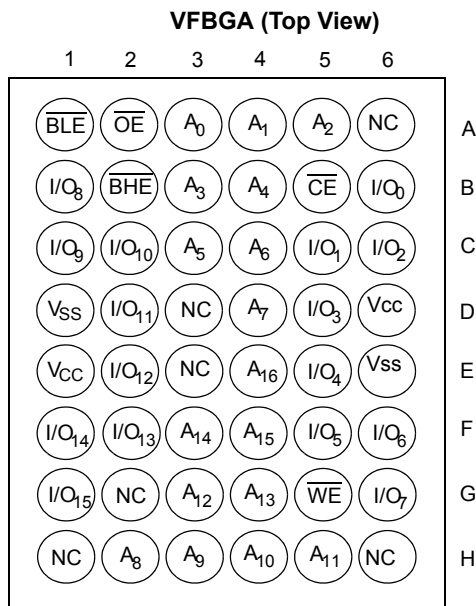

44 TSOP II (Top View)

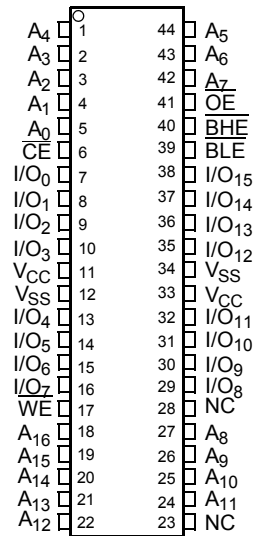

Product Portfolio

Product	V _{CC} Range (V)			Speed (ns)	Power Dissipation					
					Operating I _{CC} (mA)				Standby I _{SB2} (μA)	
					f = 1 MHz		f = f _{max}			
Min	Typ ^[4]	Max	Typ ^[4]	Max	Typ ^[4]	Max	Typ ^[4]	Max		
CY62137EV30-45LL	2.2 V	3.0 V	3.6 V	45 ns	2	2.5	15	20	1	7

Notes

2. NC pins are not connected on the die.
3. Pins D3, H1, G2, H6 and H3 in the VFBGA package are address expansion pins for 4 Mb, 8 Mb, 16 Mb, and 32 Mb and 64 Mb respectively
4. Typical values are included for reference only and are not guaranteed or tested. Typical values are measured at V_{CC} = V_{CC(typ)}, T_A = 25 °C

Maximum Ratings

Exceeding the maximum ratings may impair the useful life of the device. These user guidelines are not tested.

Storage temperature -65 °C to + 150 °C

Ambient temperature with power applied -55 °C to + 125 °C

Supply voltage to ground potential -0.3 V to (V_{CC(MAX)} + 0.3 V)

DC voltage applied to outputs in High Z state^[5, 6] -0.3 V to (V_{CC(MAX)} + 0.3 V)

DC input voltage^[5, 6] -0.3 V to (V_{CC(MAX)} + 0.3 V)

Output current into outputs (LOW) 20 mA

Static discharge voltage > 2001 V (per MIL-STD-883, Method 3015)

Latch up current > 200 mA

Operating Range

Device	Range	Ambient Temperature	V _{CC} ^[7]
CY62137EV30-45LL	Industrial	-40 °C to +85 °C	2.2 V to 3.6 V

Electrical Characteristics Over the Operating Range

Parameter	Description	Test Conditions	45 ns			Unit	
			Min	Typ ^[8]	Max		
V _{OH}	Output HIGH voltage	I _{OH} = -0.1 mA	V _{CC} = 2.20 V	2.0	-	-	V
		I _{OH} = -1.0 mA	V _{CC} = 2.70 V	2.4	-	-	V
V _{OL}	Output LOW voltage	I _{OL} = 0.1 mA	V _{CC} = 2.20 V	-	-	0.4	V
		I _{OL} = 2.1 mA	V _{CC} = 2.70 V	-	-	0.4	V
V _{IH}	Input HIGH voltage	V _{CC} = 2.2 V to 2.7 V		1.8	-	V _{CC} + 0.3	V
		V _{CC} = 2.7 V to 3.6 V		2.2	-	V _{CC} + 0.3	V
V _{IL}	Input LOW voltage	V _{CC} = 2.2 V to 2.7 V		-0.3	-	0.6	V
		V _{CC} = 2.7 V to 3.6 V		-0.3	-	0.8	V
I _{IX}	Input leakage current	GND ≤ V _I ≤ V _{CC}		-1	-	+1	μA
I _{OZ}	Output leakage current	GND ≤ V _O ≤ V _{CC} , Output disabled		-1	-	+1	μA
I _{CC}	V _{CC} Operating supply current	f = f _{max} = 1/t _{RC}	V _{CC} = V _{CCmax}	-	15	20	mA
		f = 1 MHz	I _{OUT} = 0 mA CMOS levels	-	2.0	2.5	
I _{SB1} ^[9]	Automatic CE power-down current — CMOS inputs	CE ≥ V _{CC} - 0.2 V or (BHE and BLE) ≥ V _{CC} - 0.2 V, V _{IN} ≥ V _{CC} - 0.2 V, V _{IN} ≤ 0.2 V,, f = f _{max} (address and data only), f = 0 (OE and WE), V _{CC} = 3.60 V		-	1	7	μA
I _{SB2} ^[9]	Automatic CE power-down current — CMOS inputs	CE ≥ V _{CC} - 0.2 V or (BHE and BLE) ≥ V _{CC} - 0.2 V, V _{IN} ≥ V _{CC} - 0.2 V or V _{IN} ≤ 0.2 V, f = 0, V _{CC} = 3.60 V		-	1	7	μA

Notes

- V_{L(min.)} = -2.0 V for pulse durations less than 20 ns.
- V_{IH(max.)} = V_{CC} + 0.75 V for pulse durations less than 20 ns.
- Full device AC operation assumes a 100 μs ramp time from 0 to V_{CC(min)} and 200 μs wait time after V_{CC} stabilization.
- Typical values are included for reference only and are not guaranteed or tested. Typical values are measured at V_{CC} = V_{CC(typ.)}, T_A = 25 °C.
- Chip enable (CE) and byte enables (BHE and BLE) need to be tied to CMOS levels to meet the I_{SB1} / I_{SB2} / I_{CCDR} specification. Other inputs can be left floating.

Capacitance

Parameter ^[10]	Description	Test Conditions	Max	Unit
C _{IN}	Input capacitance	T _A = 25 °C, f = 1 MHz, V _{CC} = V _{CC(typ)}	10	pF
C _{OUT}	Output capacitance		10	pF

Thermal Resistance

Parameter ^[10]	Description	Test Conditions	BGA	TSOP II	Unit
Θ _{JA}	Thermal resistance (junction to ambient)	Still air, soldered on a 3 × 4.5 inch, two-layer printed circuit board	75	77	°C / W
Θ _{JC}	Thermal resistance (junction to case)		10	13	°C / W

Figure 1. AC Test Loads and Waveforms

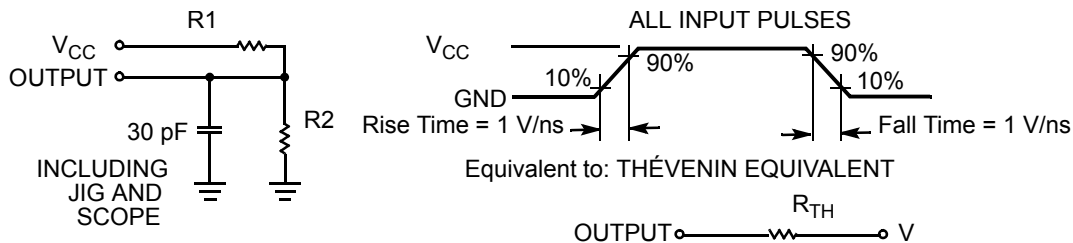

Parameters	2.50 V	3.0 V	Unit
R1	16667	1103	Ω
R2	15385	1554	Ω
R _{TH}	8000	645	Ω
V _{TH}	1.20	1.75	V

Data Retention Characteristics (Over the Operating Range)

Parameter	Description	Conditions	Min	Typ ^[11]	Max	Unit
V _{DR}	V _{CC} for data retention		1	–	–	V
I _{CDDR} ^[12]	Data retention current	V _{CC} = 1V, CE ≥ V _{CC} – 0.2 V or (BHE and BLE) ≥ V _{CC} – 0.2 V, V _{IN} ≥ V _{CC} – 0.2 V or V _{IN} ≤ 0.2 V	–	0.8	3	μA
t _{CDR} ^[10]	Chip deselect to data retention time		0	–	–	ns
t _R ^[13]	Operation recovery time		45	–	–	ns

Data Retention Waveform^[14]

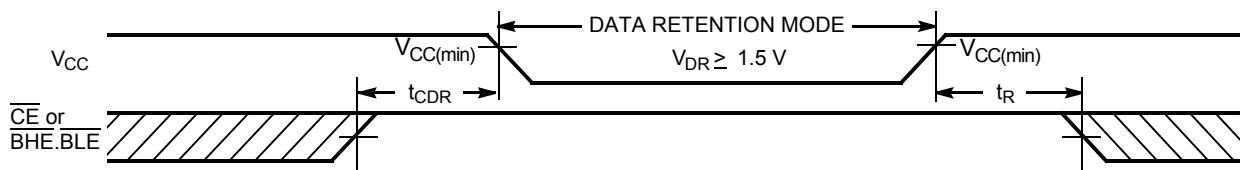

Notes

- 10. Tested initially and after any design or process changes that may affect these parameters.
- 11. Typical values are included for reference only and are not guaranteed or tested. Typical values are measured at V_{CC} = V_{CC(typ)}, T_A = 25 °C
- 12. Chip enable (CE) and byte enables (BHE and BLE) need to be tied to CMOS levels to meet the I_{SB1} / I_{SB2} / I_{CDDR} specification. Other inputs can be left floating.
- 13. Full device operation requires linear V_{CC} ramp from V_{DR} to V_{CC(min)} ≥ 100 μs or stable at V_{CC(min)} ≥ 100 μs.
- 14. BHE.BLE is the AND of both BHE and BLE. The chip can be deselected by either disabling the chip enable signals or by disabling both BHE and BLE.

Switching Characteristics

Over the Operating Range

Parameter ^[15, 16]	Description	45 ns		Unit
		Min	Max	
Read Cycle				
t_{RC}	Read cycle time	45	–	ns
t_{AA}	Address to data valid	–	45	ns
t_{OHA}	Data hold from address change	10	–	ns
t_{ACE}	\overline{CE} LOW to data valid	–	45	ns
t_{DOE}	\overline{OE} LOW to data valid	–	22	ns
t_{LZOE}	\overline{OE} LOW to Low Z ^[17]	5	–	ns
t_{HZOE}	\overline{OE} HIGH to High Z ^[17, 18]	–	18	ns
t_{LZCE}	\overline{CE} LOW to Low Z ^[17]	10	–	ns
t_{HZCE}	\overline{CE} HIGH to High Z ^[17, 18]	–	18	ns
t_{PU}	\overline{CE} LOW to power-up	0	–	ns
t_{PD}	\overline{CE} HIGH to power-down	–	45	ns
t_{DBE}	$\overline{BLE}/\overline{BHE}$ LOW to data valid	–	45	ns
t_{LZBE}	$\overline{BLE}/\overline{BHE}$ LOW to Low Z ^[17]	5	–	ns
t_{HZBE}	$\overline{BLE}/\overline{BHE}$ HIGH to HIGH Z ^[17, 18]	–	18	ns
Write Cycle^[19]				
t_{WC}	Write cycle time	45	–	ns
t_{SCE}	\overline{CE} LOW to write end	35	–	ns
t_{AW}	Address setup to write end	35	–	ns
t_{HA}	Address hold from write end	0	–	ns
t_{SA}	Address setup to write start	0	–	ns
t_{PWE}	\overline{WE} pulse width	35	–	ns
t_{BW}	$\overline{BLE}/\overline{BHE}$ LOW to write end	35	–	ns
t_{SD}	Data setup to write end	25	–	ns
t_{HD}	Data hold from write end	0	–	ns
t_{HZWE}	\overline{WE} LOW to High-Z ^[17, 18]	–	18	ns
t_{LZWE}	\overline{WE} HIGH to Low-Z ^[17]	10	–	ns

Notes

15. Test conditions for all parameters other than tri-state parameters assume signal transition time of 3 ns (1V/ns) or less, timing reference levels of $V_{CC(typ)}/2$, input pulse levels of 0 to $V_{CC(typ)}$, and output loading of the specified I_{OL}/I_{OH} as shown in [AC Test Loads and Waveforms](#).
16. AC timing parameters are subject to byte enable signals (BHE or BLE) not switching when chip is disabled. Refer application note, [AN13842](#) for more information.
17. At any given temperature and voltage condition, t_{HZCE} is less than t_{LZCE} , t_{HZBE} is less than t_{LZBE} , t_{HZOE} is less than t_{LZOE} , and t_{HZWE} is less than t_{LZWE} for any given device.
18. t_{HZOE} , t_{HZCE} , t_{HZBE} , and t_{HZWE} transitions are measured when the outputs enter a high impedance state.
19. The internal write time of the memory is defined by the overlap of \overline{WE} , $\overline{CE} = V_{IL}$, \overline{BHE} and $\overline{BLE} = V_{IL}$. All signals must be ACTIVE to initiate a write and any of these signals can terminate a write by going INACTIVE. The data input setup and hold timing should be referenced to the edge of the signal that terminates the write.

Switching Waveforms

Figure 2. Read Cycle 1: Address Transition Controlled [20, 21]

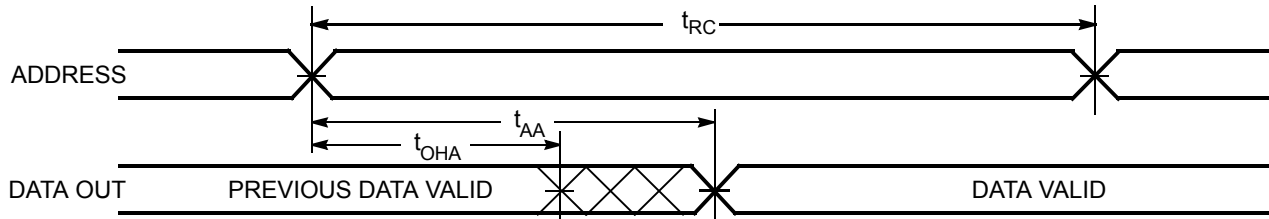
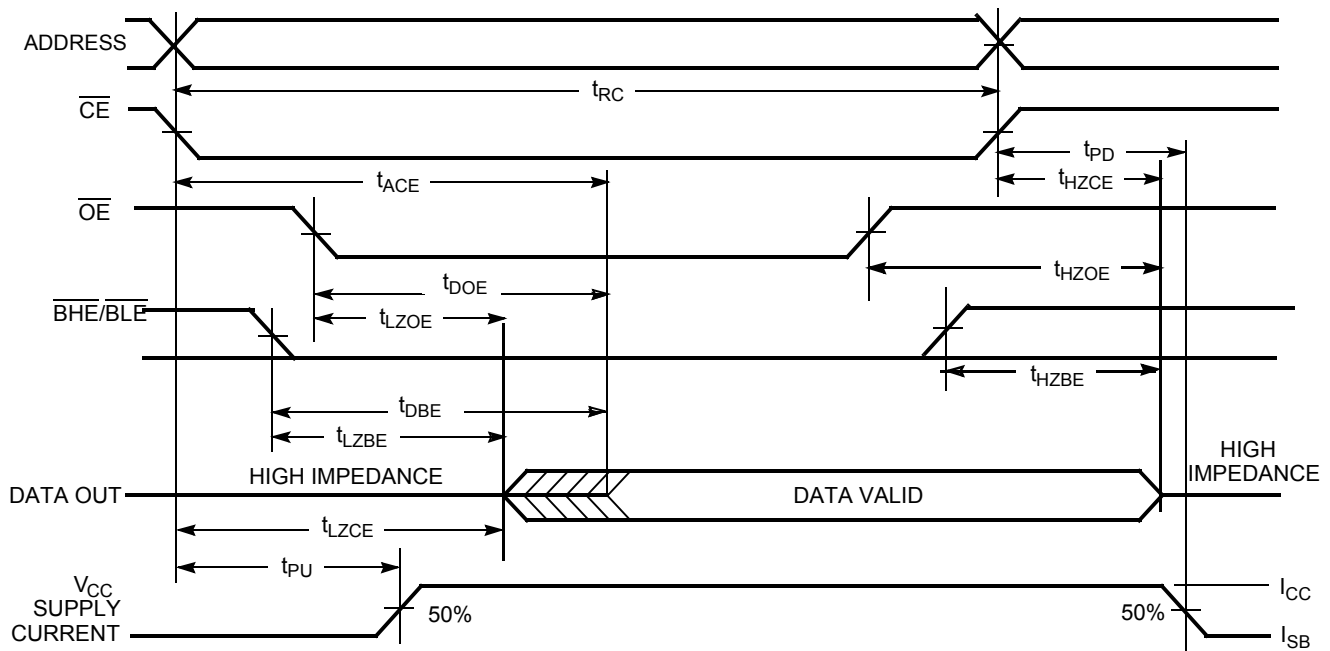

Figure 3. Read Cycle No. 2: \overline{OE} Controlled [21, 22]



Notes

- 20. The device is continuously selected. \overline{OE} , \overline{CE} = V_{IL} , \overline{BHE} and \overline{BLE} = V_{IL} .
- 21. \overline{WE} is HIGH for read cycle.
- 22. Address valid prior to or coincident with \overline{CE} and \overline{BHE} , \overline{BLE} transition LOW.

Switching Waveforms (continued)

Figure 4. Write Cycle No. 1: $\overline{\text{WE}}$ Controlled [23, 24, 25]

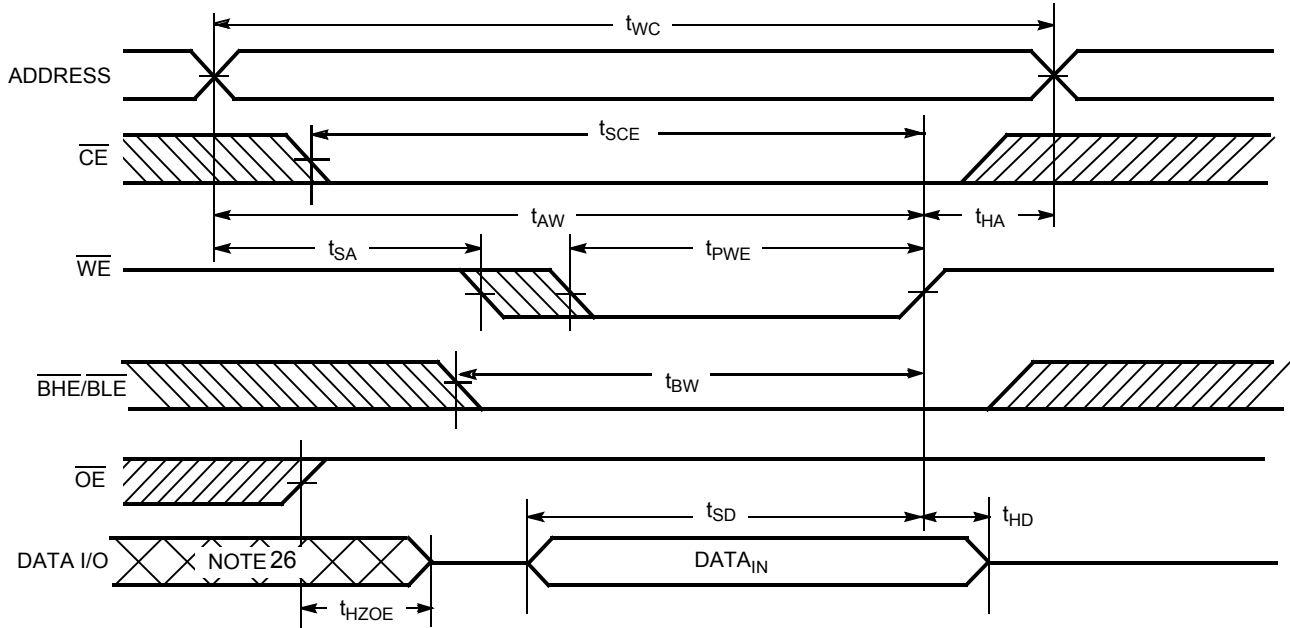
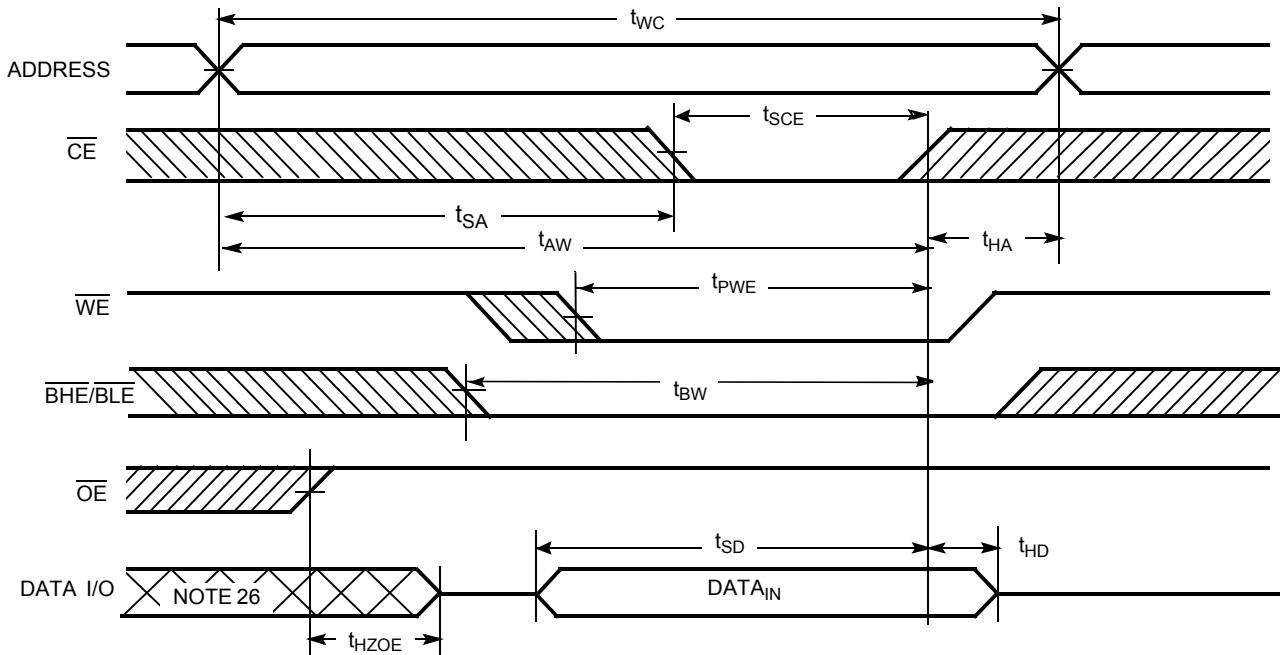

Figure 5. Write Cycle No. 2: $\overline{\text{CE}}$ Controlled [23, 24, 25]



Notes

- 23. The internal write time of the memory is defined by the overlap of $\overline{\text{WE}}$, $\overline{\text{CE}} = V_{IL}$, $\overline{\text{BHE}}$ and $\overline{\text{BLE}} = V_{IL}$. All signals must be ACTIVE to initiate a write and any of these signals can terminate a write by going INACTIVE. The data input setup and hold timing should be referenced to the edge of the signal that terminates the write.
- 24. Data I/O is high impedance if $\overline{\text{OE}} = V_{IH}$.
- 25. If $\overline{\text{CE}}$ goes HIGH simultaneously with $\overline{\text{WE}} = V_{IH}$, the output remains in a high impedance state.
- 26. During this period, the I/Os are in output state and input signals should not be applied.

Switching Waveforms (continued)

Figure 6. Write Cycle No. 3: \overline{WE} Controlled, \overline{OE} LOW ^[27]

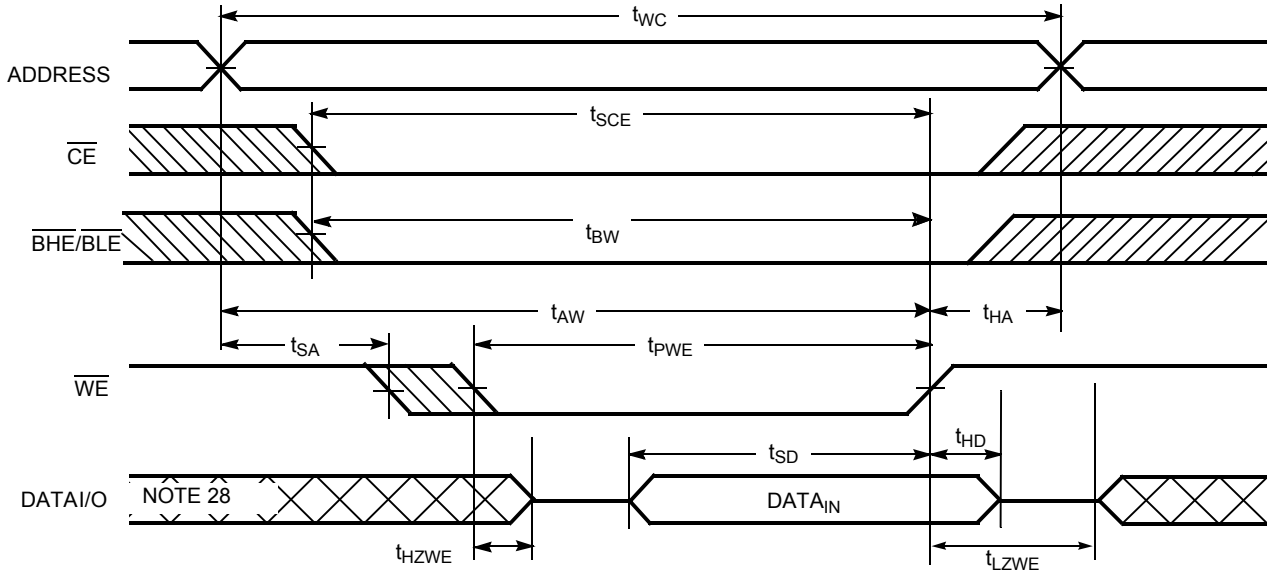
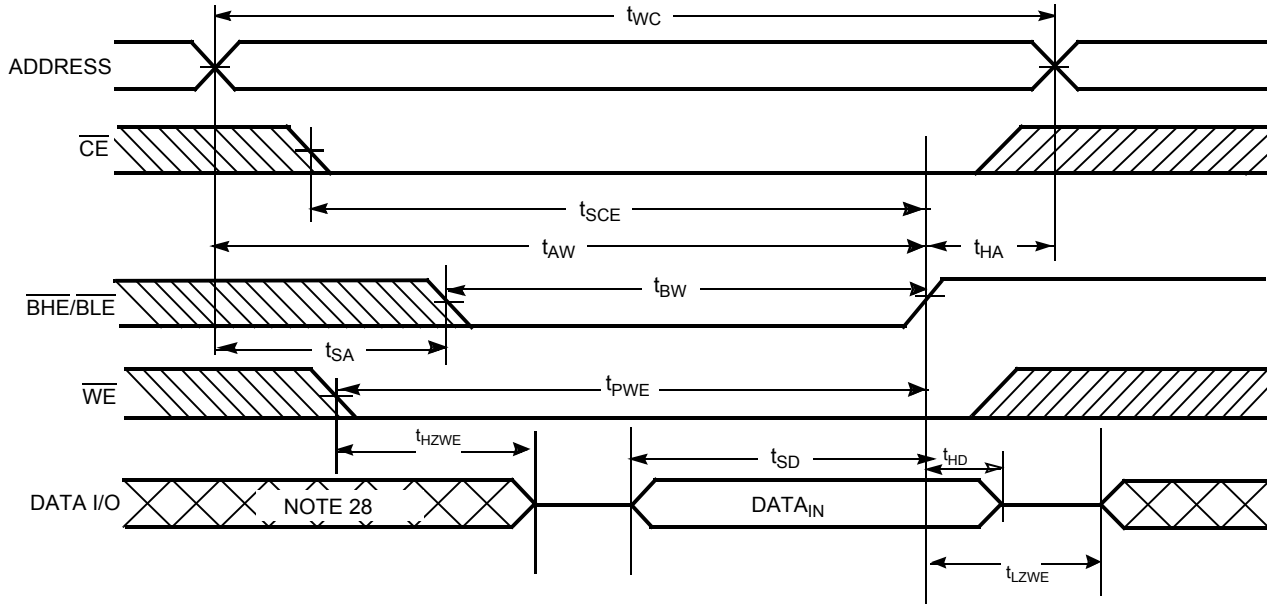

Figure 7. Write Cycle No. 4: $\overline{BHE}/\overline{BLE}$ Controlled, \overline{OE} LOW ^[27]



Notes

- 27. If CE goes HIGH simultaneously with $\overline{WE} = V_{IH}$, the output remains in a high impedance state.
- 28. During this period, the I/Os are in output state and input signals should not be applied.

Truth Table

$\overline{\text{CE}}$	$\overline{\text{WE}}$	$\overline{\text{OE}}$	$\overline{\text{BHE}}$	$\overline{\text{BLE}}$	Inputs/Outputs	Mode	Power
H	X	X	X ^[29]	X ^[29]	High Z	Deselect/power-down	Standby (I _{SB})
X ^[29]	X	X	H	H	High Z	Deselect/power-down	Standby (I _{SB})
L	H	L	L	L	Data out (I/O ₀ –I/O ₁₅)	Read	Active (I _{CC})
L	H	L	H	L	Data out (I/O ₀ –I/O ₇); I/O ₈ –I/O ₁₅ in High Z	Read	Active (I _{CC})
L	H	L	L	H	Data out (I/O ₈ –I/O ₁₅); I/O ₀ –I/O ₇ in High Z	Read	Active (I _{CC})
L	H	H	L	L	High Z	Output disabled	Active (I _{CC})
L	H	H	H	L	High Z	Output disabled	Active (I _{CC})
L	H	H	L	H	High Z	Output disabled	Active (I _{CC})
L	L	X	L	L	Data in (I/O ₀ –I/O ₁₅)	Write	Active (I _{CC})
L	L	X	H	L	Data in (I/O ₀ –I/O ₇); I/O ₈ –I/O ₁₅ in High Z	Write	Active (I _{CC})
L	L	X	L	H	Data in (I/O ₈ –I/O ₁₅); I/O ₀ –I/O ₇ in High Z	Write	Active (I _{CC})

Note

29. Chip enable ($\overline{\text{CE}}$) and Byte enables ($\overline{\text{BHE}}$ / $\overline{\text{BLE}}$) must be at fixed CMOS levels (not floating). Intermediate voltage levels on these pins is not permitted

Ordering Information

Speed (ns)	Ordering Code	Package Diagram	Package Type	Operating Range
45	CY62137EV30LL-45BVXI	51-85150	48-Ball Very Fine Pitch BGA (6 mm × 8mm × 1 mm) (Pb-free)	Industrial
45	CY62137EV30LL-45ZSXI	51-85087	44-Pin TSOP II (Pb-free)	

Ordering Code Definition

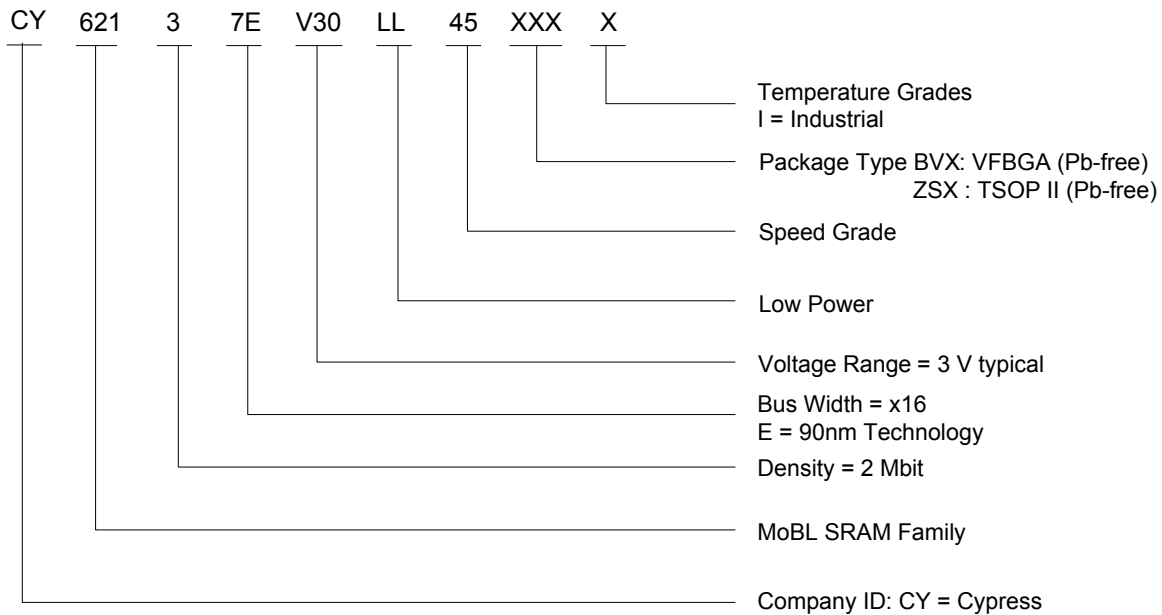

Package Diagrams

Figure 8. 48-Pin VFBGA (6 x 8 x 1 mm) (51-85150)

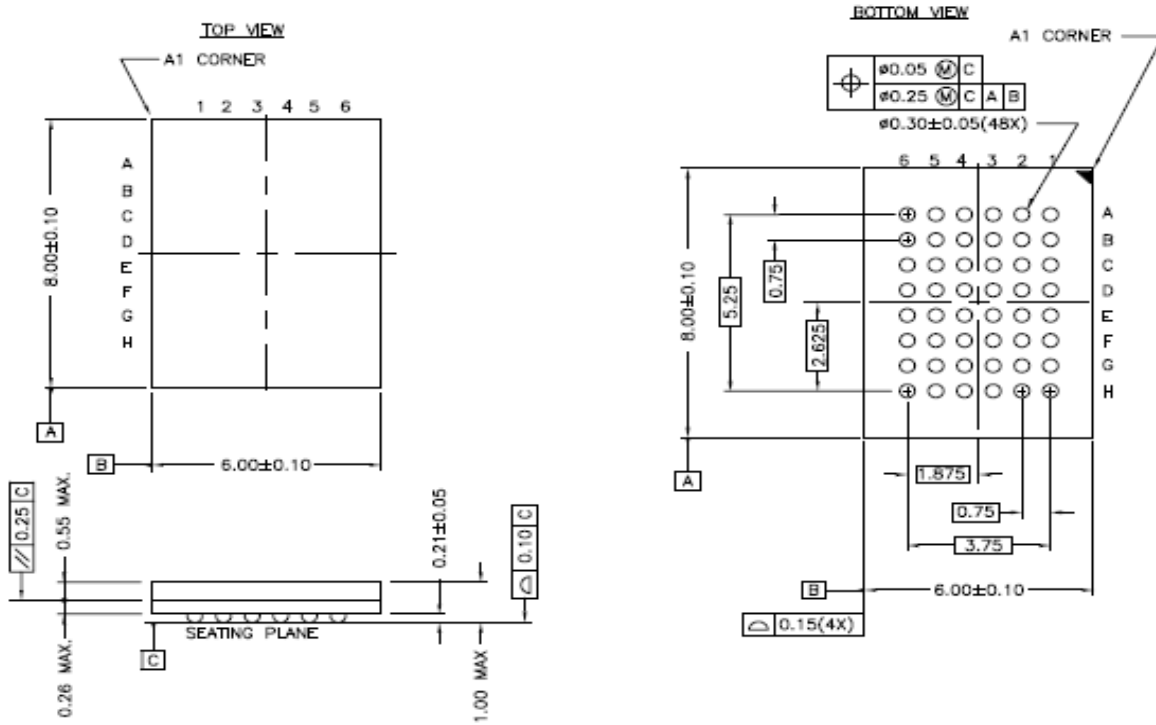

51-85150-*F

Package Diagrams (continued)

Figure 9. 44-Pin TSOP II (51-85087)

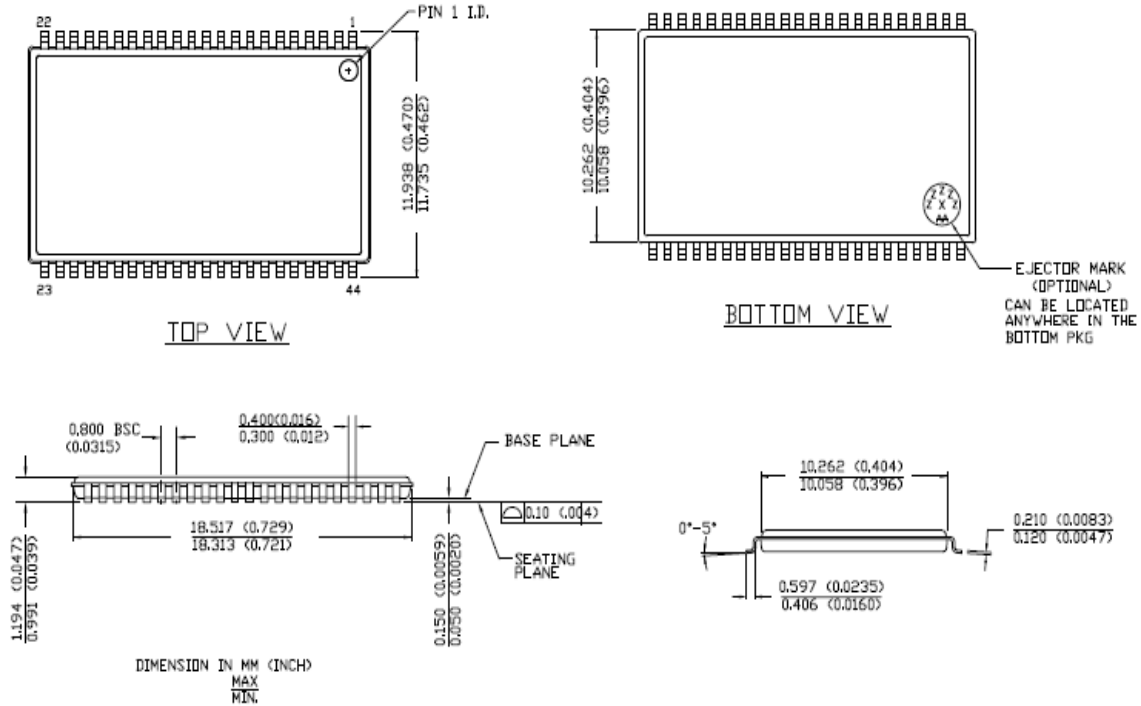

51-85087-°C

Acronyms

Acronym	Description
CMOS	complementary metal oxide semiconductor
I/O	input/output
SRAM	static random access memory
VFBGA	very fine ball grid array
TSOP	thin small outline package

Document Conventions

Units of Measure

Symbol	Unit of Measure
°C	degrees Celsius
μA	microamperes
mA	milliamperes
MHz	megahertz
ns	nanoseconds
pF	picofarads
V	volts
Ω	ohms
W	watts

Document History Page

Document Title: CY62137EV30 MoBL® 2-Mbit (128K x 16) Static RAM				
Document Number: 38-05443				
Rev.	ECN No.	Orig. of Change	Submission Date	Description of Change
**	203720	AJU	See ECN	New Data Sheet
*A	234196	AJU	See ECN	<p>Changed I_{CC} MAX at f=1MHz from 1.7 mA to 2.0 mA</p> <p>Changed I_{CC} TYP from 12 mA (35 ns speed bin) and 10 mA (45 ns speed bin) to 15 mA and 12 mA respectively</p> <p>Changed I_{CC} MAX from 20 mA (35 ns speed bin) and 15 mA (45 ns speed bin) to 25 mA and 20 mA respectively</p> <p>Changed I_{SB1} and I_{SB2} TYP from 0.6 μA to 0.7 μA</p> <p>Changed I_{SB1} and I_{SB2} MAX from 1.5 μA to 2.5 μA</p> <p>Changed I_{CCDR} from 1 μA to 2 μA</p> <p>Fixed typos on TSOP II pinout:</p> <p>Pin 18-22: address lines</p> <p>Pin 23: NC</p> <p>Added Pb-free information</p>
*B	427817	NXR	See ECN	<p>Converted from Advanced Information to Final.</p> <p>Removed 35 ns Speed Bin</p> <p>Removed "L" version</p> <p>Changed ball E3 from DNU to NC.</p> <p>Removed the redundant footnote on DNU.</p> <p>Moved Product Portfolio from Page # 3 to Page #2.</p> <p>Changed I_{CC} (Max) value from 2 mA to 2.5 mA and I_{CC} (Typ) value from 1.5 mA to 2 mA at f=1 MHz</p> <p>Changed I_{CC} (Typ) value from 12 mA to 15 mA at f = f_{max}=1/t_{RC}</p> <p>Changed I_{SB1} and I_{SB2} Typ. values from 0.7 μA to 1 μA and Max. values from 2.5 μA to 7 μA.</p> <p>Changed V_{CC} stabilization time in footnote #7 from 100 μs to 200 μs</p> <p>Changed the AC test load capacitance from 50pF to 30pF on Page# 4</p> <p>Changed V_{DR} from 1.5V to 1V on Page# 4.</p> <p>Changed I_{CCDR} from 2 μA to 3 μA.</p> <p>Added I_{CCDR} typical value.</p> <p>Corrected t_R in Data Retention Characteristics from 100 μs to t_{RC} ns</p> <p>Changed t_{OHA}, t_{LZCE} and t_{LZWE} from 6 ns to 10 ns</p> <p>Changed t_{LZBE} from 6 ns to 5 ns</p> <p>Changed t_{LZOE} from 3 ns to 5 ns</p> <p>Changed t_{HZOE}, t_{HZCE}, t_{HZBE} and t_{HZWE} from 15 ns to 18 ns</p> <p>Changed t_{SCE}, t_{AW} and t_{BW} from 40 ns to 35 ns</p> <p>Changed t_{PWE} from 30 ns to 35 ns</p> <p>Changed t_{SD} from 20 ns to 25 ns</p> <p>Updated the Ordering Information table and replaced the Package Name column with Package Diagram.</p>
*C	2604685	VKN/PYRS	11/12/08	<p>Added footnote 8 related to I_{SB2} and I_{CCDR}</p> <p>Added footnote 13 related to AC timing parameters</p>
*D	3143896	RAME	01/17/2011	<p>Added Acronyms and Units of Measure table</p> <p>Added Ordering Code Definition</p> <p>Added TOC</p> <p>Converted all tablenote to footnotes</p> <p>Updated Package Diagrams 51-85150 from *D to *F</p>

Sales, Solutions, and Legal Information

Worldwide Sales and Design Support

Cypress maintains a worldwide network of offices, solution centers, manufacturer's representatives, and distributors. To find the office closest to you, visit us at cypress.com/sales.

Products

Automotive	cypress.com/go/automotive
Clocks & Buffers	cypress.com/go/clocks
Interface	cypress.com/go/interface
Lighting & Power Control	cypress.com/go/powerpsoc cypress.com/go/plc
Memory	cypress.com/go/memory
Optical & Image Sensing	cypress.com/go/image
PSoC	cypress.com/go/psoc
Touch Sensing	cypress.com/go/touch
USB Controllers	cypress.com/go/USB
Wireless/RF	cypress.com/go/wireless

PSoC Solutions

psoc.cypress.com/solutions
PSoC 1 | PSoC 3 | PSoC 5

© Cypress Semiconductor Corporation, 2008-2011. The information contained herein is subject to change without notice. Cypress Semiconductor Corporation assumes no responsibility for the use of any circuitry other than circuitry embodied in a Cypress product. Nor does it convey or imply any license under patent or other rights. Cypress products are not warranted nor intended to be used for medical, life support, life saving, critical control or safety applications, unless pursuant to an express written agreement with Cypress. Furthermore, Cypress does not authorize its products for use as critical components in life-support systems where a malfunction or failure may reasonably be expected to result in significant injury to the user. The inclusion of Cypress products in life-support systems application implies that the manufacturer assumes all risk of such use and in doing so indemnifies Cypress against all charges.

Any Source Code (software and/or firmware) is owned by Cypress Semiconductor Corporation (Cypress) and is protected by and subject to worldwide patent protection (United States and foreign), United States copyright laws and international treaty provisions. Cypress hereby grants to licensee a personal, non-exclusive, non-transferable license to copy, use, modify, create derivative works of, and compile the Cypress Source Code and derivative works for the sole purpose of creating custom software and or firmware in support of licensee product to be used only in conjunction with a Cypress integrated circuit as specified in the applicable agreement. Any reproduction, modification, translation, compilation, or representation of this Source Code except as specified above is prohibited without the express written permission of Cypress.

Disclaimer: CYPRESS MAKES NO WARRANTY OF ANY KIND, EXPRESS OR IMPLIED, WITH REGARD TO THIS MATERIAL, INCLUDING, BUT NOT LIMITED TO, THE IMPLIED WARRANTIES OF MERCHANTABILITY AND FITNESS FOR A PARTICULAR PURPOSE. Cypress reserves the right to make changes without further notice to the materials described herein. Cypress does not assume any liability arising out of the application or use of any product or circuit described herein. Cypress does not authorize its products for use as critical components in life-support systems where a malfunction or failure may reasonably be expected to result in significant injury to the user. The inclusion of Cypress' product in a life-support systems application implies that the manufacturer assumes all risk of such use and in doing so indemnifies Cypress against all charges.

Use may be limited by and subject to the applicable Cypress software license agreement.