

Z-PAC[®]

DC/DC CONVERTERS

KEY FEATURES

- Efficiency 90% Minimum
- Input/Output Isolated
- PC Mountable
- Single and Combinable Dual Output
- Designed To Meet FCC SEC 15, Sub-part J, A & B
- Balanced Load
- Full Range Operating to 85°C
- Designed For Low Noise, High Efficiency Applications
- Outputs May Be Paralleled
- Three Year Warranty

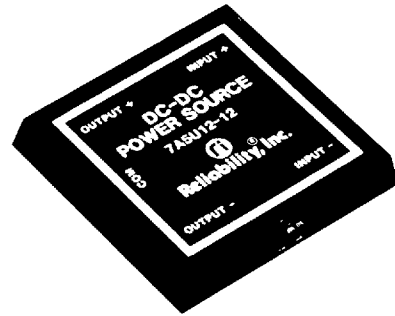

DESCRIPTION

The Z-PAC Series of DC/DC converters provides the performance advantages of conventional linear converters with a minimum efficiency of 90%. The units are designed to encompass A/D and D/A converters, operational amplifiers, RS232, 444 and 488 as well as negative voltage biasing. The units are also suitable in battery or solar powered equipment and in a wide variety of other uses in commercial and industrial equipment. The 18 Watt model is specifically intended for Ethernet/Cheapernet Hub applications. The series operates from inputs of 5 and 12 VDC with single and dual outputs. All Z-PAC devices operate over their full temperature range with no derating.

SELECTION GUIDE

Standard Products

DEVICE TYPE	INPUT VOLTAGE RANGE VDC	INPUT CURRENT A (MAX) (80% FL)	OUTPUT VOLTAGE VDC	OUTPUT CURRENT ma (MAX)	PACKAGE/ PINOUT
7A5U5	4.5 - 5.5	1.5	+ or -5	1500	A
7D5U5	4.5 - 5.5	1.5	+ or -5	1500	D
7A12U5	10.8 - 13.2	0.63	+ or -5	1500	A
7D12U5	10.8 - 13.2	0.63	+ or -5	1500	D
7A5U12-12	4.5 - 5.5	1.3	+ and -12	±300	A
7D5U12-12	4.5 - 5.5	1.3	+ and -12	±300	D
7A12U12-12	10.8 - 13.2	0.53	+ and -12	±300	A
7D12U12-12	10.8 - 13.2	0.53	+ and -12	±300	D
7A5U15-15	4.5 - 5.5	1.4	+ and -15	±250	A
7D5U15-15	4.5 - 5.5	1.4	+ and -15	±250	D
7A12U15-15	10.8 - 13.2	.6	+ and -15	±250	A
7D12U15-15	10.8 - 13.2	.6	+ and -15	±250	D
7A5U15	4.5 - 5.5	1.4	+ or -15	500	A
9ZA12U9	11.4 - 12.6	.9 FL	+ or -9	1000	A
18ZA12U9	11.4 - 12.6	1.6 FL	+ or -9	2000	A



7652818 0000170 T2T

GENERAL ELECTRICAL SPECIFICATIONS

(Specifications at Nominal Input and 25°C)

PARAMETER	LIMIT	CONDITIONS
Input Voltage Range	± 20%	All Units
Input Filter	Yes	All Units
Input Ripple Current	5% (Pk-Pk)	Of Average Input Current
Maximum Input Voltage ⁽¹⁾	8V, 15V (max.)	5V & 12V Inputs, Respectively
Output Voltage	See Selection Guide	
Output Current	See Selection Guide	
Output Voltage Accuracy	± 3%	80% of Full Load, Nominal Input
Output Ripple and Noise	100mV P-P	20 Hz - 20 MHz, BW Ext. Cap Across Outputs - See Test Circuit
Load Regulation	See Graphs	Balanced Loads
Line Regulation	1.25%/1% (Max.)	$\Delta V_o / \Delta V_{in}$, 80% Full Load
Minimum Load	25ma	All Units
Isolation	500 VDC	All Units
Efficiency ⁽²⁾	90% (Min.)	80% of Full Load Nominal Input
Short Circuit Protection	Momentary	Recommended for Full Protection Use External Fuse
Operating Temperature	-40°C to +85°C	See Application Notes
Storage Temperature	-55°C to 125°C	No Derating
Case	2" x 2" x 0.375"	Ryton UL 94V-0
FCC Sect. 15 Sub Part J	Yes	Class B Radiated, Class A Conducted

- (1) Note that the output voltage will increase accordingly. Units may be operated at maximum input voltage continuously.
 (2) Minimum of 85% for single 5V output and 9V output unit.
 (3) Other variations available. Consult factory.

MECHANICAL SPECIFICATIONS

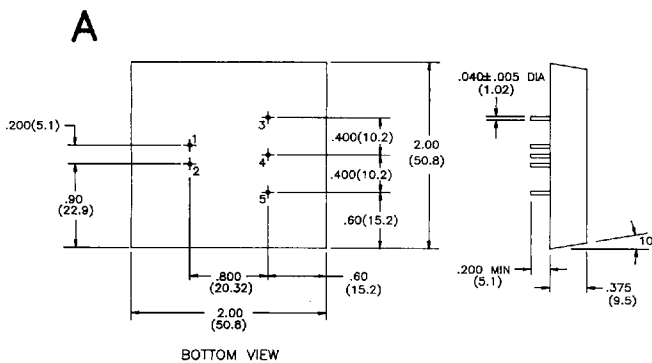

PIN	SINGLE OUTPUT	PIN	DUAL OUTPUT
1	+INPUT	1	+INPUT
2	-INPUT	2	-INPUT
3	+OUTPUT	3	+OUTPUT
4	-OUTPUT	4	COMMON
5	-OUTPUT	5	-OUTPUT

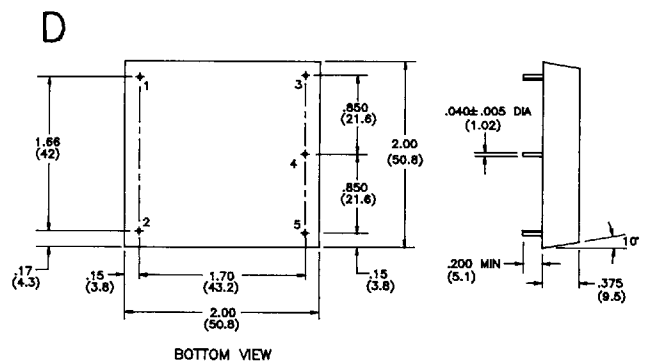

NOTES:

1. ALL DIMENSIONS IN PARENTHESES ARE METRIC.
2. TOLERANCES UNLESS OTHERWISE SPECIFIED: .XX = ±.03 (.76)
.XXX = ±.015 (.38)

7652818 0000171 966

PERFORMANCE GRAPHS

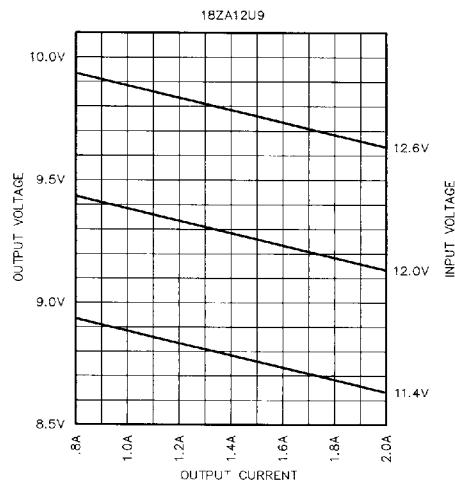
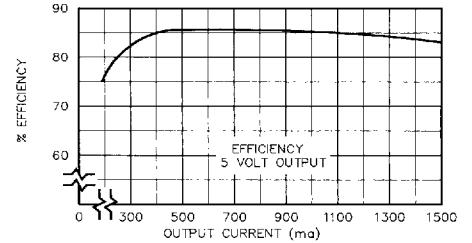
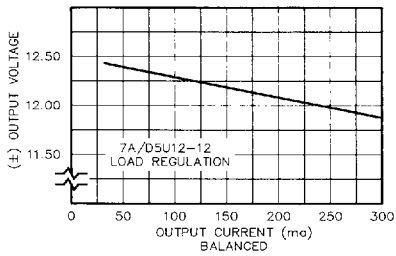
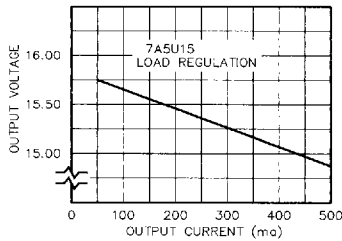
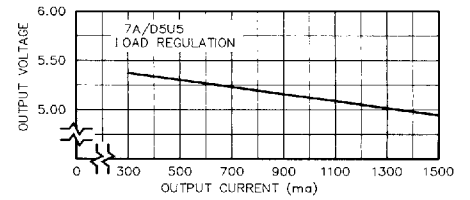
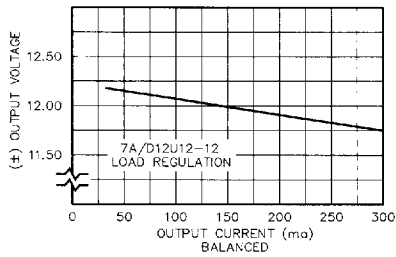
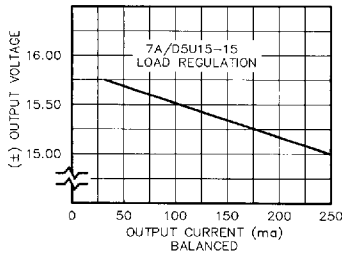
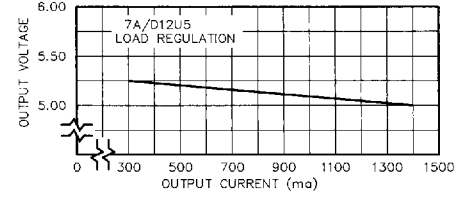
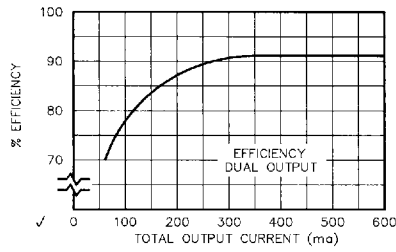
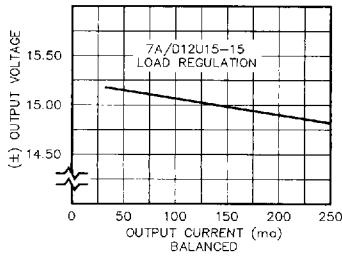

7652818 0000172 8T2

TEST CIRCUIT SCHEMATIC AND OUTPUT NOISE

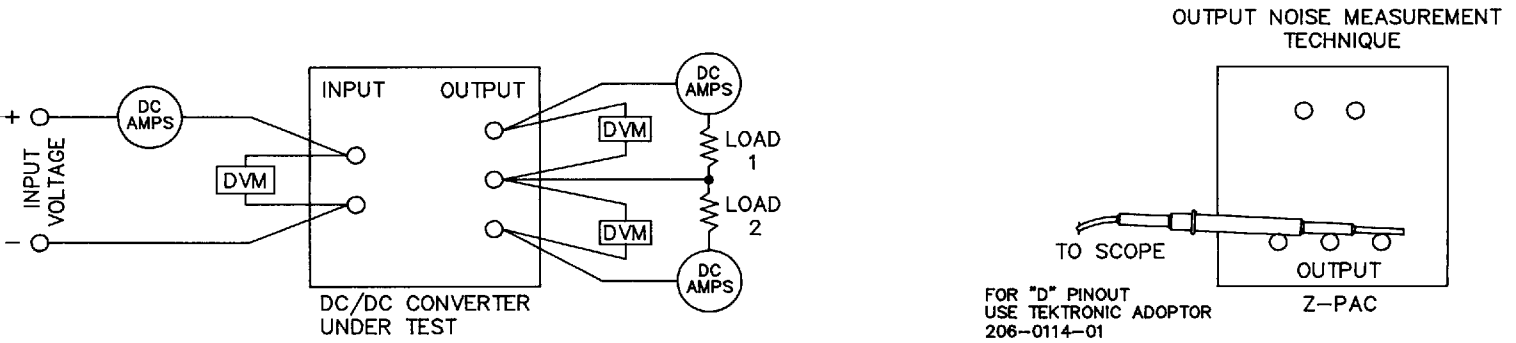

Noise measurements must be made with care in order to avoid introducing extraneous signals. The oscilloscope ground clip lead should not be used. This clip lead forms an inductive pickup loop when placed in a field of radiated high frequency energy. To measure output noise, press the ground band or ring of the oscilloscope probe directly against the output common terminal of the DC/DC converter while the tip makes contact with the voltage output terminal. The scope bandwidth should be 20 MHz and a .1 ufd capacitor parallel with a 47 ufd capacitor across each output. For optimum noise performance, these capacitors should be installed as close to the output pins as possible. A ground plane under the entire unit will also improve noise and reduce any radiated interference from the converter.

The 7A/D provides momentary short circuit protection but good design practice will require a fuse on the DC/DC input to prevent large circulating currents in an output short. When using the 7A/D units at full rated power we recommend a max of a 2 amp fuse on the 5 volt input units and a 1 amp fuse for 12 volt inputs. When using other than full rated power, to calculate the fuse size required, determine the maximum output power and multiply by 1.1 to obtain the input power. Divide the input power by the minimum input voltage to determine the maximum input current. Select a fuse with a current rating 1.25 times the maximum input current. If the unit is to be operated at elevated temperatures, be sure to further derate the fuse.

Do not operate the converters under no load conditions. To prevent high output voltages always have at least 25ma of load current on each output.

The positive or negative output may be used as an output common to obtain 24 or 30 VDC. In this application do not use pin 4, the standard output common. The maximum output current will be as specified for a single output, i.e., 300ma for 24V and 250ma for 30 VDC.

Reliability Incorporated
P.O. Box 218370
Houston, TX 77218
TEL: (713) 492-0550
FAX: (713) 492-0615

East Coast Sales Office
P.O. Box 157
Dunstable, MA 01827
TEL: (508) 937-4055
FAX: (508) 649-9319

Reliability Singapore Pte. Ltd.
5004 Ang Mo Kio
Avenue 5, #04-01
Singapore 2056
TEL: 65-481-9266
FAX: 65-481-2612

RICR de Costa Rica S.A.
P.O. Box 1-3006
Zone Franca Metropolitana
Barreal, Heredia
Costa Rica, A.C.
TEL: 506-293-4384
FAX: 506-293-4621

European Sales Office
P.O. Box 87
Newbury
Berkshire, RG14 6YT
England
TEL: 44-635-522298
FAX: 44-635-580870

Copyright© 1994, Reliability Incorporated.
Reliability reserves the right to make changes in the product at any time, without notification.
12-54-12M-694

■ 7652818 0000173 739 ■

These products are not authorized for use as critical components in life support devices or systems without the express written approval of an officer of Reliability Incorporated.