

PLEASE CHECK WWW.MOLEX.COM FOR LATEST PART INFORMATION

Part Number: [0003091063](#)
Status: **Active**
Overview: [standard_093](#)
Description: 2.36mm (.093") Diameter Standard .093 Pin and Socket Receptacle Housing, 6 Circuits, Dual Row, without Panel Mount Ears, without Friction Lock Ramp

Documents:

3D Model	Product Specification PS-02-09 (PDF)
Drawing (PDF)	Product Specification PS-43660-9999 (PDF)
Packaging Specification (PDF)	RoHS Certificate of Compliance (PDF)

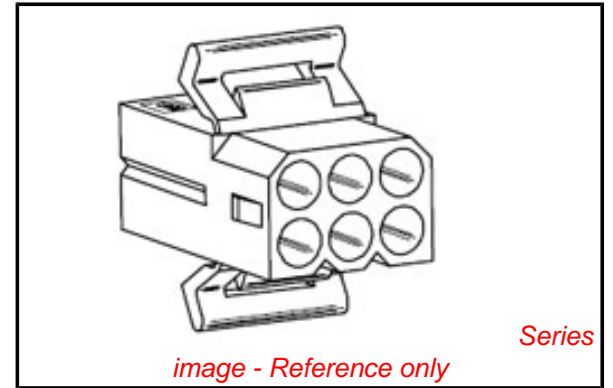

Agency Certification

CSA	LR19980
UL	E29179

General

Product Family	Crimp Housings
Series	1261
Comments	14.0A max. can be achieved when housing is used with 42477 or 42478 terminals
Overview	standard_093
Product Name	Standard .093"

Physical

Circuits (maximum)	6
Color - Resin	Natural
Flammability	94V-2
Gender	Dual
Glow-Wire Compliant	No
Lock to Mating Part	None
Material - Resin	Nylon
Number of Rows	2
Packaging Type	Bag
Panel Mount	No
Pitch - Mating Interface (in)	0.198 In
Pitch - Mating Interface (mm)	5.03 mm
Stackable	No
Temperature Range - Operating	-40°C to +105°C

Electrical

Current - Maximum per Contact	11A
-------------------------------	-----

Material Info

Old Part Number	1261-R2
-----------------	---------

Reference - Drawing Numbers

Packaging Specification	PK-1261-001
Product Specification	PS-02-09, PS-43660-9999
Sales Drawing	SD-1261-*

EU RoHS

ELV and RoHS Compliant
REACH SVHC Contains SVHC: No
Halogen-Free
Status Not Reviewed

China RoHS



Need more information on product environmental compliance?

Email productcompliance@molex.com
 For a multiple part number RoHS Certificate of Compliance, [click here](#)

Please visit the [Contact Us](#) section for any non-product compliance questions.

Search Parts in this Series

[1261Series](#)

Mates With

[3099](#) shrouded PCB connector, [1261p](#)

Use With

[1189](#) Crimp Terminals, [1190](#) Crimp Terminals, [1376](#) Male PC Tail Terminals, [1377](#) Female PC Tail Terminals, [1380](#) Male Crimp Terminals, [1381](#) Female Crimp Terminals, [1433](#) Crimp Terminals, [1434](#) Male Crimp Terminals, [1973](#) , [2151](#) , [2273](#) , [2870](#) , [2871](#) , [4272](#) , [4550](#) , [6271](#) , [6310](#) , [42477](#) , [42478](#)

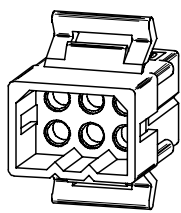
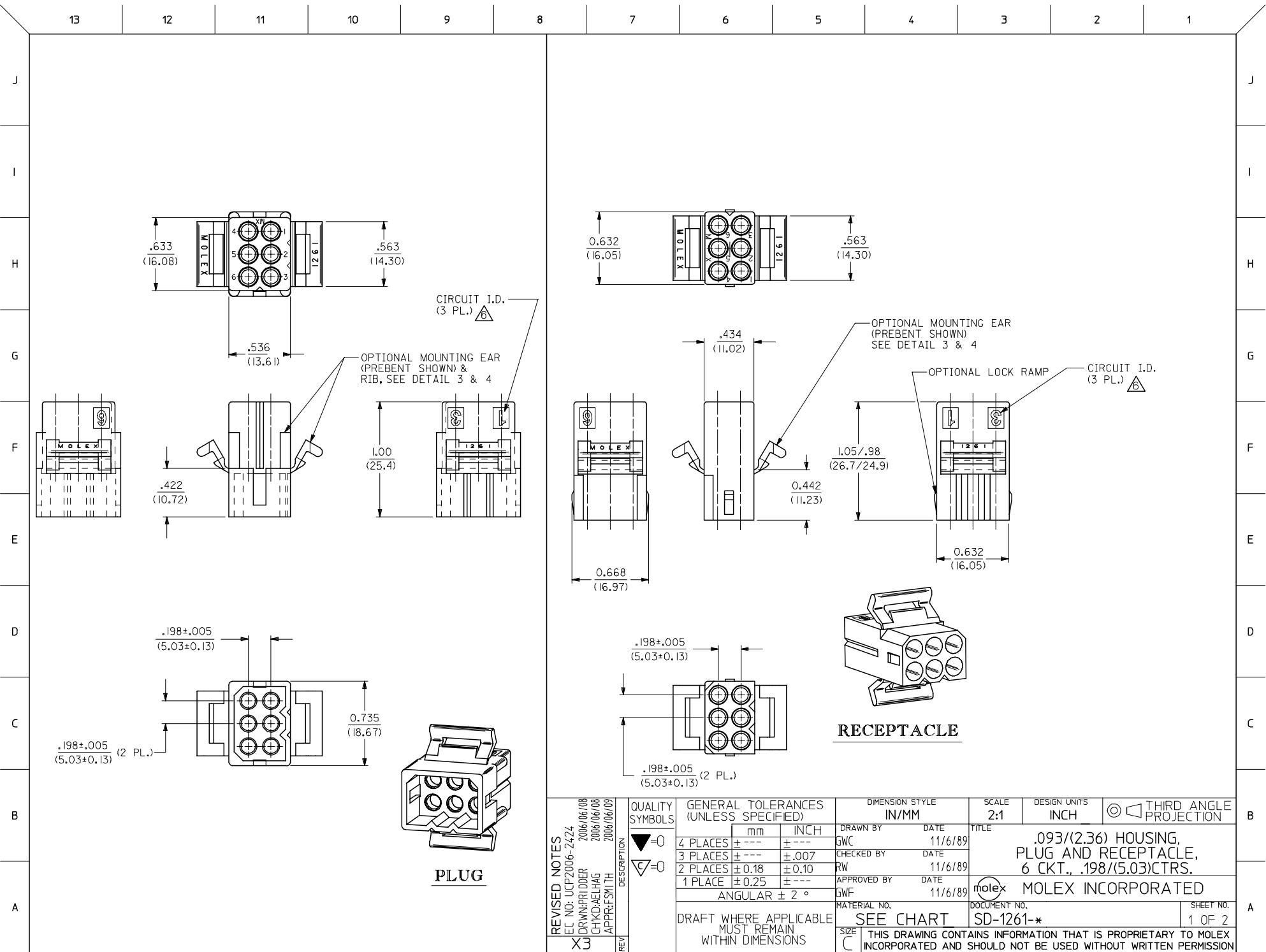

PLUG

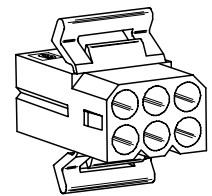

RECEPTACLE

REVISED NOTES EC NO: UCP2006-2424 DRAWN/PRI/DOR 2006/06/08 CHKD: AEL/HAG 2006/06/08 APPR: FSM/TH 2006/06/09	DESCRIPTION X3	QUALITY SYMBOLS ▽=0 ▽=0	GENERAL TOLERANCES (UNLESS SPECIFIED) <table border="1"> <thead> <tr> <th></th> <th>mm</th> <th>INCH</th> </tr> </thead> <tbody> <tr> <td>4 PLACES</td> <td>± .005</td> <td>± .0002</td> </tr> <tr> <td>3 PLACES</td> <td>± .007</td> <td>± .0003</td> </tr> <tr> <td>2 PLACES</td> <td>± 0.18</td> <td>± 0.10</td> </tr> <tr> <td>1 PLACE</td> <td>± 0.25</td> <td>± .010</td> </tr> </tbody> </table>		mm	INCH	4 PLACES	± .005	± .0002	3 PLACES	± .007	± .0003	2 PLACES	± 0.18	± 0.10	1 PLACE	± 0.25	± .010	DIMENSION STYLE IN/MM	SCALE 2:1	DESIGN UNITS INCH	THIRD ANGLE PROJECTION
			mm	INCH																		
		4 PLACES	± .005	± .0002																		
		3 PLACES	± .007	± .0003																		
2 PLACES	± 0.18	± 0.10																				
1 PLACE	± 0.25	± .010																				
DRAFT WHERE APPLICABLE MUST REMAIN WITHIN DIMENSIONS			SEE CHART	SD-1261-*	1 OF 2																	
THIS DRAWING CONTAINS INFORMATION THAT IS PROPRIETARY TO MOLEX INCORPORATED AND SHOULD NOT BE USED WITHOUT WRITTEN PERMISSION																						

PLUG

PART NO.	ENG. NO.
03-09-2061	I261-P
23-09-2061	I261-P-100
03-09-2062	I261-P1
23-09-2062	I261-P1-100
03-09-7061	I261-PBK
03-09-7062	I261-PIBK
27-09-2093	I261-PI-200
50-29-0099	I261-PI-300

RECEPTACLE

PART NO.	ENG. NO.
03-09-1061	I261-R
23-09-1061	I261-R-100
03-09-1062	I261-R1
23-09-1062	I261-R1-100
03-09-1063	I261-R2
23-09-1063	I261-R2-100
03-09-1064	I261-R3
27-09-1063	I261-R2-200
03-09-6064	I261-R3BK
03-09-6063	I261-R2BK
03-09-6062	I261-RIBK
03-09-6061	I261-RBK
50-29-1500	I261-R3-300

LEGEND: PLUG

I261-P***-***
 P = PLUG
 BLANK = PLUG WITH PREBENT MOUNTING EARS
 I = PLUG WITHOUT MOUNTING EARS
 COLOR: BLANK=NATURAL COLOR
 AM=AMBER BK=BLACK BU=BLUE
 BN=BROWN GY=GRAY GN=GREEN
 OR=ORANGE RD=RED YW=YELLOW
 MATERIAL: BLANK = NYLON 6/6, U.L. 94V-2
 100 = POLYPROPYLENE, U.L. 94V-0
 200 = NYLON 6/6, U.L. 94V-0, RED
 300 = NYLON 6/6, U.L. 94V-2, BLACK
 UV RESISTANT

LEGEND: RECEPTACLE

I261-R***-***
 R = RECEPTACLE
 BLANK = WITH STD. MOUNTING EARS, WITH LOCK RAMP
 1 = WITH STD. MOUNTING EARS, WITHOUT LOCK RAMP
 2 = WITHOUT MOUNTING EARS, WITHOUT LOCK RAMP
 3 = WITHOUT MOUNTING EARS, WITH LOCK RAMP
 4 = WITH PREBENT MOUNTING EARS, WITH LOCK RAMP
 5 = WITH PREBENT MOUNTING EARS, WITHOUT LOCK RAMP
 COLOR: BLANK=NATURAL COLOR
 AM=AMBER BK=BLACK BU=BLUE
 BN=BROWN GY=GRAY GN=GREEN
 OR=ORANGE RD=RED YW=YELLOW
 MATERIAL: BLANK = NYLON 6/6, U.L. 94V-2
 100 = POLYPROPYLENE, U.L. 94V-0
 200 = NYLON 6/6, U.L. 94V-0, RED
 300 = NYLON 6/6, U.L. 94V-2, BLACK
 UV RESISTANT

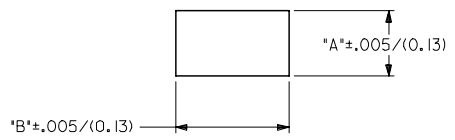
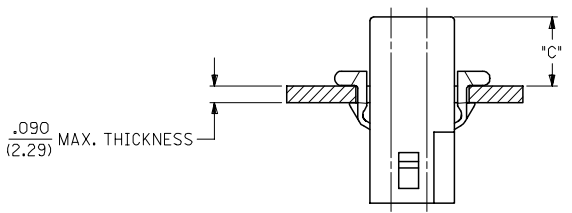

MOUNTING HOLE CUTOUT

HOUSING	DIM. 'A'	DIM. 'B'	DIM. 'C' (STD. EAR)	DIM. 'C' (PREBENT)
PLUG	.750/(19.05)	.695/(17.65)	.39/(9.9)	.40/(10.1)
RECEPTACLE	.718/(18.24)	.600/(15.24)	.40/(10.1)	.41/(10.3)

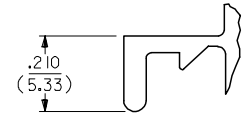

DETAIL 3

.093/(2.36) STANDARD MOUNTING EAR
 (SCALE 4:1)

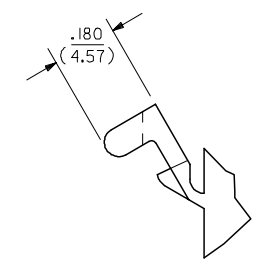
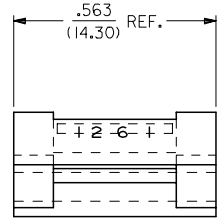

DETAIL 4

.093/(2.36) PREBENT MOUNTING EAR
 (SCALE 4:1)

NOTES:

- MATERIAL: SEE LEGEND
- FINISH: NONE.
- PRODUCT SPECIFICATION: PS-43660-9999
- PACKAGING INFORMATION: PK-1261-001
- HOUSINGS FOR USE WITH MOLEX .093/(2.36) PIN AND SOCKET TERMINALS.
- CIRCUIT I.D. NUMBERS ON SIDE OF HOUSING APPEAR ON PARTS FROM TOOLS BUILT AFTER 9/3/91.
- WHERE DENOTED IN CHART, TOOLS ARE BUILT WITH PREBENT MOUNTING EARS PER DETAIL 4 AND SUPERSEDE ALL TOOLS PREVIOUSLY BUILT WITH THE STANDARD MOUNTING EAR.
- TEXT AND CIRCUIT IDENTIFIERS ARE SHOWN IN APPROXIMATE LOCATION BUT MAY VARY TO ACCOMMODATE TOOLING.

UPDATED NOTES EC NO: UCP2006-2424 DRAWN: P. DDER 2006/06/08 CHKD: AELHAG 2006/06/08 APPR: FSM TH 2006/06/09 X3	QUALITY SYMBOLS ▽=0 ▽=0	GENERAL TOLERANCES (UNLESS SPECIFIED) mm INCH		DIMENSION STYLE IN/MM		SCALE 4:1	DESIGN UNITS INCH	THIRD ANGLE PROJECTION
		4 PLACES ± .007 ± .007	DRAWN BY GWF	DATE 11/10/89	.093/(2.36) HOUSING, PLUG AND RECEPTACLE, 6 CKT., .198/(5.03) CTRS.			
		3 PLACES ± .007 ± .010	CHECKED BY RW	DATE 11/10/89	MOLEX INCORPORATED			
		2 PLACES ± 0.18 ± .010	APPROVED BY GWF	DATE 11/10/89	MATERIAL NO. SD-1261-* DOCUMENT NO. SHEET NO. 2 OF 2			
DRAFT WHERE APPLICABLE MUST REMAIN WITHIN DIMENSIONS		SEE CHART		THIS DRAWING CONTAINS INFORMATION THAT IS PROPRIETARY TO MOLEX INCORPORATED AND SHOULD NOT BE USED WITHOUT WRITTEN PERMISSION				