

PLEASE CHECK WWW.MOLEX.COM FOR LATEST PART INFORMATION

Part Number: [0330015003](#)
Status: **Active**
Overview: [mx150 sealed connector system](#)
Description: MX150™ Female Terminal, Silver (Ag) Plating, 22 AWG, Left Reel Payoff, Small Polarization Rib, Contact Material Thickness 0.30mm (.012")

Documents:

[Drawing \(PDF\)](#) [RoHS Certificate of Compliance \(PDF\)](#)

General

Product Family	Crimp Terminals
Series	33001
Comments	Left Reel Payoff, Small Polarization Rib
Crimp Quality Equipment	Yes
Overview	mx150 sealed connector system
Product Name	MX150™

Physical

Gender	Female
Material - Metal	High Performance Alloy (HPA)
Material - Plating Mating	Silver
Material - Plating Termination	Tin
Packaging Type	Reel
Plating min: Mating (µin)	30.4
Plating min: Mating (µm)	0.76
Plating min: Termination (µin)	100
Plating min: Termination (µm)	2.5
Termination Interface: Style	Crimp or Compression
Wire Insulation Diameter	2.60mm (.102") max.
Wire Size AWG	22
Wire Size mm²	0.5

Electrical

Current - Maximum per Contact	22A
Voltage - Maximum	250V

Material Info

Reference - Drawing Numbers

Sales Drawing	SD-33012-002
---------------	--------------

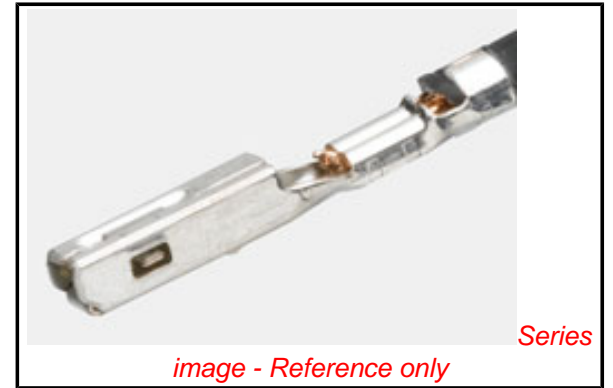

image - Reference only

EU RoHS

**ELV and RoHS
Compliant**
**REACH SVHC
Contains SVHC: No**
**Halogen-Free
Status**

China RoHS



Not Reviewed

Need more information on product environmental compliance?

Email productcompliance@molex.com
 For a multiple part number RoHS Certificate of Compliance, [click here](#)

Please visit the [Contact Us](#) section for any non-product compliance questions.

Search Parts in this Series

[33001Series](#)

Use With

[33472](#) Dual Row Housing. [33476](#) Hybrid Housing. [33471](#) Single Row Housing

Application Tooling | FAQ

Tooling specifications and manuals are found by selecting the products below. Crimp Height Specifications are then contained in the Application Tooling Specification document.

Global

Description	Product #
Manual Extraction Tool	0638131500
FineAdjust™ Applicator	0639001000
Hand Crimp Tool, 18-22AWG	0638116000
Hand Crimp Tool, Metric 0.05 and 0.75	0638116200

This document was generated on 05/27/2010

PLEASE CHECK WWW.MOLEX.COM FOR LATEST PART INFORMATION

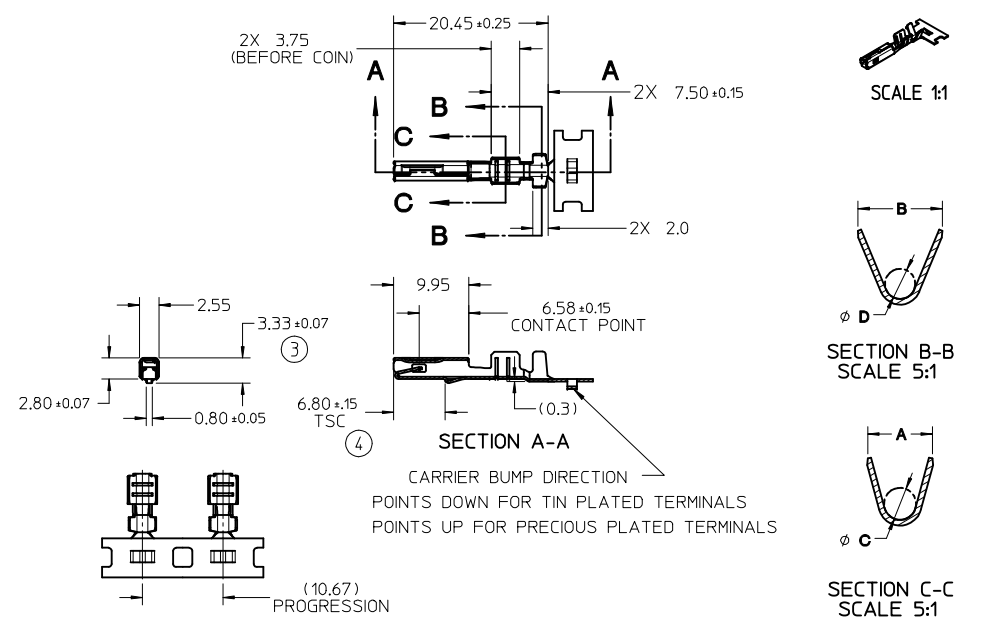
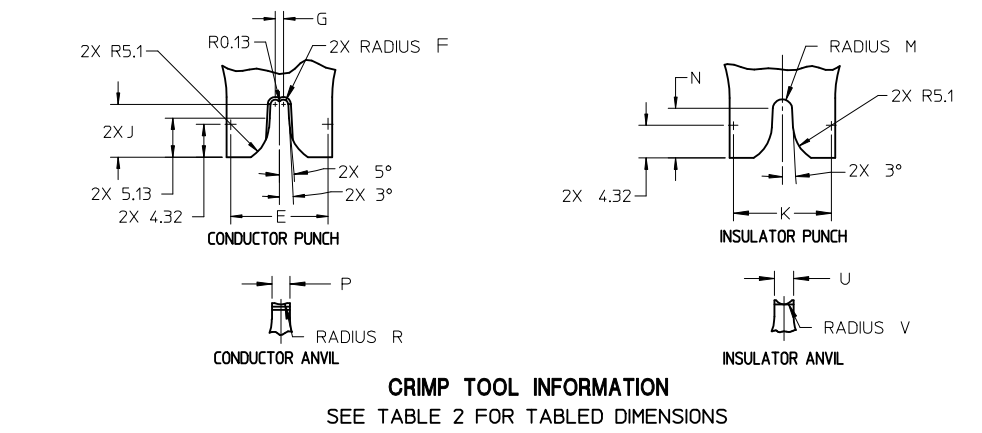
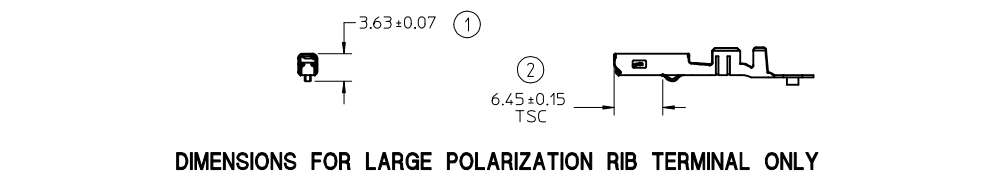
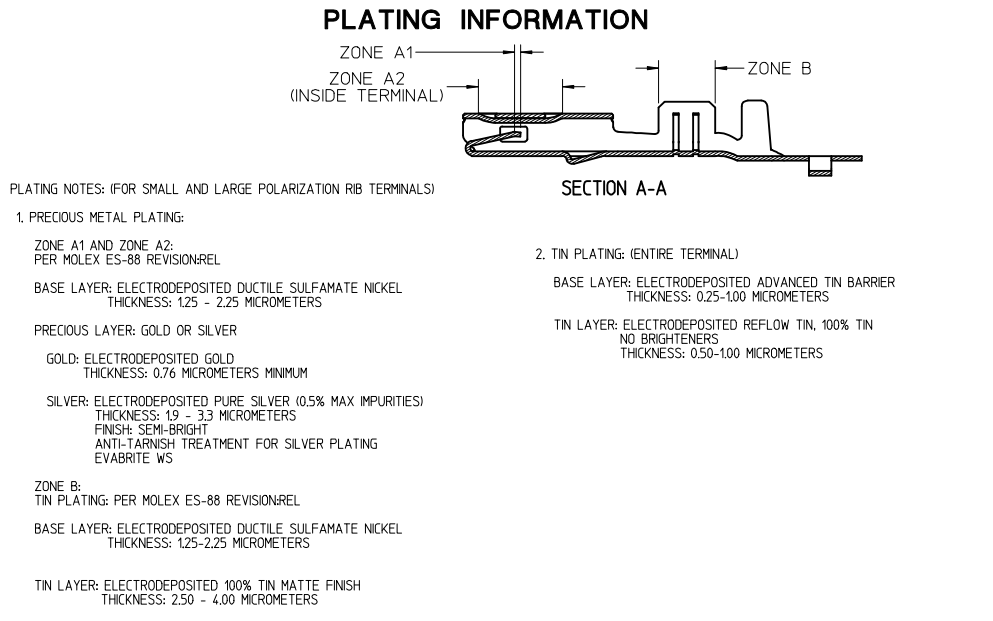
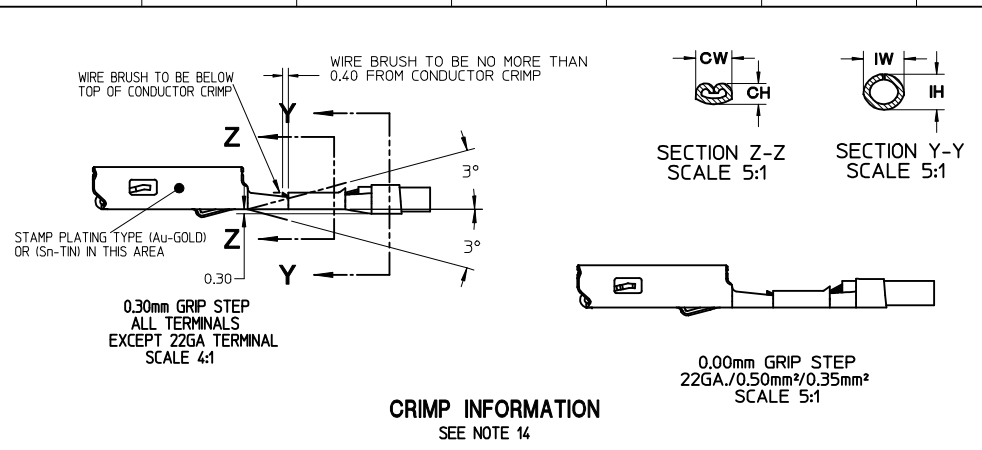

- NOTES: (UNLESS OTHERWISE SPECIFIED)
- MATING TERMINAL SHOWN ON SD-33000-001
 - MATERIAL: ASTM B422, UNS C19025, HR04
THICKNESS: 0.30 mm ±0.01
TEMPER: FULL HARD (REF)
TENSILE: 496 MIN MPA
PLATING: SEE PLATING NOTES ABOVE
 - MEETS PERFORMANCE SPECIFICATION FOR CABLE TO TERMINAL ELECTRICAL CRIMPS PER SAE/USCAR-21 (8/2001)
 - MEETS PERFORMANCE STANDARD FOR AUTOMOTIVE ELECTRICAL CONNECTOR SYSTEMS FOR SAE/USCAR-2, REV. 4 (TEMP CLASS 3) (4/2001)
 - MEETS ELECTRICAL CONNECTION SYSTEM DESIGN SPECIFICATION (SDS) REV.11 (5/2002)
 - MEETS FIELD CORRELATED LIFE TEST (FCLT) PER SAE/USCAR-20 (11/2001)
 - MEETS WIRING COMPONENT DESIGN GUIDELINES SAE/USCAR-12 REV 2 (12/2001)
 - TSC ON A DIMENSION TO BE INTERPRETED AS DISTANCE TO A THEORETICAL SHARP CORNER AS IF THE RADIUS WERE NOT PRESENT
 - DRAWING CONFORMS TO AVP-(I401/T406)-001 REVISION A DATED 2/16/99
 - REFERENCE 97B5-14474-AAB FOR LARGE POLARIZATION RIB CAVITY SPECIFICATION
 - INSERTION FORCE (TIN) AVG. FROM PV TESTING =
3.8N LARGE POLARIZATION RIB
3.5N SMALL POLARIZATION RIB (REFERENCE)
 - ALL DIMENSIONS EXCEPT ①, ②, ③ & ④ ARE COMMON TO BOTH SMALL AND LARGE POLARIZATION RIB TERMINALS
 - REFERENCE PK-31300-516 FOR REEL DIRECTION
 - REFERENCE CS-33012-002 FOR ADDITIONAL CRIMP INFORMATION

ENTER DESCRIPTION EC NO: JAU2010-0107 DRAWN BY: DRWINKFERGUSON CHKD: A. DHIR APPR: B. MOSER 2009/08/19 2009/08/20	QUALITY SYMBOLS ▽=0 ▽=0	GENERAL TOLERANCES (UNLESS SPECIFIED)		DIMENSION STYLE MM ONLY		SCALE 2:1	DESIGN UNITS METRIC	THIRD ANGLE PROJECTION	
		mm	INCH	DRAWN BY L. PULLIAM	DATE 2005/06/21	TITLE MX150 RECEPTACLE TERMINAL			
B1	REV	4 PLACES	± .005	± .005	CHECKED BY A. DHIR	DATE 2005/06/21	MOLEX MOLEX INCORPORATED		
		3 PLACES	± 0.10	± 0.10	APPROVED BY B. MOSER	DATE 2005/06/22			
		2 PLACES	± 0.3	± 0.3	MATERIAL NO. SEE TABLE		DOCUMENT NO. SD-33012-002	SHEET NO. 1 OF 5	
		1 PLACE	± 3°	± 3°	THIS DRAWING CONTAINS INFORMATION THAT IS PROPRIETARY TO MOLEX INCORPORATED AND SHOULD NOT BE USED WITHOUT WRITTEN PERMISSION				

TABLE 1 - TERMINAL CRIMP DIM. REFERENCE TABLE

J	SUPPLIER PART NO.		FORD PART NO.	PLATING	WIRE SIZE (awg)	WIRE SPECIFICATION	CONDUCTOR	CONDUCTOR	INSULATOR	INSULATOR	WIRE PULL FORCE (N)		
	CH (SEC Z-Z)	CW (SEC Z-Z)					IH (SEC Y-Y)	IW (SEC Y-Y)					
SMALL POLARIZATION RIB													
RIGHT PAYOFF	LEFT PAYOFF												
I	33012-2001	33012-3001	7C3T-14474-EA	TIN	14	MIL-123A	1.65	2.45	2.90	2.75	2.68		
						MIL-135A1	1.65	2.45	2.70	2.60	2.68		
					16	MIL-123A	1.35	2.45	2.40	2.60	2.22		
	33012-2002	33012-3002	7C3T-14474-DA	TIN	18	MIL-123A	1.25	2.15	2.00	2.30	157		
						SAE J1128 (IGXL)	1.25	2.15	2.40	2.60	158		
					20	MIL-123A	1.15	2.15	1.90	2.10	128		
	33012-2003	33012-3003	7C3T-14474-CA	TIN	22	MIL-123A	1.00	1.60	1.85	1.90	88		
						JASO D 611 (AVSSI)	1.60	2.45	2.90	2.75	231		
						150mm ²	MIL-126A1	1.40	2.45	2.60	2.60	257	
	33012-2001	33012-3001	7C3T-14474-EA	TIN		100mm ²	MIL-126A1	1.30	2.15	2.00	211		
						0.75mm ²	MIL-126A1	1.25	2.15	1.95	2.10	142	
						0.50mm ²	MIL-126A1	1.10	1.60	1.80	1.90	111	
33012-2003	33012-3003	7C3T-14474-CA	TIN		0.50mm ²	JASO D 611 (AVSSI)	1.10	1.60	1.85	1.90	125		
					0.35mm ²	WSK-1A348-A2	0.95	1.60	1.70	1.90	50		
					14	MIL-123A	1.65	2.45	2.90	2.75	268		
H	33001-2003	33001-3003	7C3T-14474-HA	GOLD	14	MIL-123A	1.65	2.45	2.90	2.75	268		
						MIL-135A1	1.65	2.45	2.70	2.60	268		
					16	MIL-123A	1.35	2.45	2.40	2.60	222		
	33001-2004	33001-3004	7C3T-14474-GA	GOLD	18	MIL-123A	1.25	2.15	2.00	2.30	157		
						SAE J1128 (IGXL)	1.25	2.15	2.40	2.60	158		
					20	MIL-123A	1.15	2.15	1.90	2.10	128		
	33001-2005	33001-3005	7C3T-14474-FA	GOLD		100mm ²	MIL-126A1	1.25	2.15	1.95	2.10	142	
						0.75mm ²	MIL-126A1	1.25	2.15	1.95	2.10	142	
						0.50mm ²	MIL-126A1	1.10	1.60	1.80	1.90	111	
	33001-2003	33001-3003	7C3T-14474-HA	GOLD		0.50mm ²	JASO D 611 (AVSSI)	1.10	1.60	1.85	1.90	125	
						0.35mm ²	WSK-1A348-A2	0.95	1.60	1.70	1.90	50	
						14	MIL-123A	1.65	2.45	2.90	2.75	268	
G	33001-2004	33001-3004	7C3T-14474-GA	GOLD	14	MIL-123A	1.65	2.45	2.90	2.75	268		
						MIL-135A1	1.65	2.45	2.70	2.60	268		
					16	MIL-123A	1.35	2.45	2.40	2.60	222		
	33001-2005	33001-3005	7C3T-14474-FA	GOLD	18	MIL-123A	1.25	2.15	2.00	2.30	157		
						SAE J1128 (IGXL)	1.25	2.15	2.40	2.60	158		
					20	MIL-123A	1.15	2.15	1.90	2.10	128		
	33001-2003	33001-3003	7C3T-14474-HA	GOLD		100mm ²	MIL-126A1	1.25	2.15	1.95	2.10	142	
						0.75mm ²	MIL-126A1	1.25	2.15	1.95	2.10	142	
						0.50mm ²	MIL-126A1	1.10	1.60	1.80	1.90	111	
	33001-2005	33001-3005	7C3T-14474-FA	GOLD		0.50mm ²	JASO D 611 (AVSSI)	1.10	1.60	1.85	1.90	125	
						0.35mm ²	WSK-1A348-A2	0.95	1.60	1.70	1.90	50	
						14	MIL-123A	1.65	2.45	2.90	2.75	268	
F	33001-4001	33001-5001	7U5T-14474-UA	SILVER**	14	MIL-123A	1.65	2.45	2.90	2.75	268		
						MIL-135A1	1.65	2.45	2.70	2.60	268		
					16	MIL-123A	1.35	2.45	2.40	2.60	222		
	33001-4002	33001-5002	7U5T-14474-TA	SILVER**	18	MIL-123A	1.25	2.15	2.00	2.30	157		
						SAE J1128 (IGXL)	1.25	2.15	2.40	2.60	158		
					20	MIL-123A	1.15	2.15	1.90	2.10	128		
	33001-4003	33001-5003	7U5T-14474-SA	SILVER**		100mm ²	MIL-126A1	1.25	2.15	1.95	2.10	142	
						150mm ²	MIL-126A1	1.40	2.45	2.60	2.60	257	
						100mm ²	MIL-126A1	1.30	2.15	2.00	2.30	211	
	33001-4002	33001-5002	7U5T-14474-TA	SILVER**		0.75mm ²	MIL-126A1	1.25	2.15	1.95	2.10	142	
						0.50mm ²	MIL-126A1	1.10	1.60	1.80	1.90	111	
						0.35mm ²	JASO D 611 (AVSSI)	1.10	1.60	1.85	1.90	125	
33001-4003	33001-5003	7U5T-14474-SA	SILVER**		0.35mm ²	WSK-1A348-A2	0.95	1.60	1.70	1.90	50		
					14	MIL-123A	1.65	2.45	2.90	2.75	268		
					MIL-135A1	1.65	2.45	2.70	2.60	268			
E	33012-2021	33012-3021	7C3T-14474-LA	TIN	14	MIL-123A	1.65	2.45	2.90	2.75	268		
						MIL-135A1	1.65	2.45	2.70	2.60	268		
					16	MIL-123A	1.35	2.45	2.40	2.60	222		
	33012-2022	33012-3022	7C3T-14474-KA	TIN	18	MIL-123A	1.25	2.15	2.00	2.30	157		
						SAE J1128 (IGXL)	1.25	2.15	2.40	2.60	158		
					20	MIL-123A	1.15	2.15	1.90	2.10	128		
	33012-2023	33012-3023	7C3T-14474-JA	TIN	22	MIL-123A	1.00	1.60	1.85	1.90	88		
						JASO D 611 (AVSSI)	1.60	2.45	2.90	2.75	231		
						150mm ²	MIL-126A1	1.40	2.45	2.60	2.60	257	
	33012-2021	33012-3021	7C3T-14474-LA	TIN		100mm ²	MIL-126A1	1.30	2.15	2.00	2.30	211	
						0.75mm ²	MIL-126A1	1.25	2.15	1.95	2.10	142	
						0.50mm ²	MIL-126A1	1.10	1.60	1.80	1.90	111	
33012-2023	33012-3023	7C3T-14474-JA	TIN		0.50mm ²	JASO D 611 (AVSSI)	1.10	1.60	1.85	1.90	125		
					0.35mm ²	WSK-1A348-A2	0.95	1.60	1.70	1.90	50		
					14	MIL-123A	1.65	2.45	2.90	2.75	268		
D	33001-2021	33001-3021	7C3T-14474-PA	GOLD	14	MIL-123A	1.65	2.45	2.90	2.75	268		
						MIL-135A1	1.65	2.45	2.70	2.60	268		
					16	MIL-123A	1.35	2.45	2.40	2.60	222		
	33001-2022	33001-3022	7C3T-14474-NA	GOLD	18	MIL-123A	1.25	2.15	2.00	2.30	157		
						SAE J1128 (IGXL)	1.25	2.15	2.40	2.60	158		
					20	MIL-123A	1.15	2.15	1.90	2.10	128		
	33001-2023	33001-3023	7C3T-14474-MA	GOLD		100mm ²	MIL-126A1	1.25	2.15	1.95	2.10	142	
						150mm ²	MIL-126A1	1.40	2.45	2.60	2.60	257	
						100mm ²	MIL-126A1	1.30	2.15	2.00	2.30	211	
	33001-2022	33001-3022	7C3T-14474-PA	GOLD		0.75mm ²	MIL-126A1	1.25	2.15	1.95	2.10	142	
						0.50mm ²	MIL-126A1	1.10	1.60	1.80	1.90	111	
						0.35mm ²	JASO D 611 (AVSSI)	1.10	1.60	1.85	1.90	125	
33001-2023	33001-3023	7C3T-14474-MA	GOLD		0.35mm ²	WSK-1A348-A2	0.95	1.60	1.70	1.90	50		
					14	MIL-123A	1.65	2.45	2.90	2.75	268		
					MIL-135A1	1.65	2.45	2.70	2.60	268			
C	33001-2021	33001-3021	7C3T-14474-PA	GOLD	14	MIL-123A	1.65	2.45	2.90	2.75	268		
						MIL-135A1	1.65	2.45	2.70	2.60	268		
					16	MIL-123A	1.35	2.45	2.40	2.60	222		
	33001-2022	33001-3022	7C3T-14474-NA	GOLD	18	MIL-123A	1.25	2.15	2.00	2.30	157		
						SAE J1128 (IGXL)	1.25	2.15	2.40	2.60	158		
					20	MIL-123A	1.15	2.15	1.90	2.10	128		
	33001-2023	33001-3023	7C3T-14474-MA	GOLD		100mm ²	MIL-126A1	1.25	2.15	1.95	2.10	142	
						150mm ²	MIL-126A1	1.40	2.45	2.60	2.60	257	
						100mm ²	MIL-126A1	1.30	2.15	2.00	2.30	211	
	33001-2022	33001-3022	7C3T-14474-PA	GOLD		0.75mm ²	MIL-126A1	1.25	2.15	1.95	2.10	142	
						0.50mm ²	MIL-126A1	1.10	1.60	1.80	1.90	111	
						0.35mm ²	JASO D 611 (AVSSI)	1.10	1.60	1.85	1.90	125	
33001-2023	33001-3023	7C3T-14474-MA	GOLD		0.35mm ²	WSK-1A348-A2	0.95	1.60	1.70	1.90	50		
					14	MIL-123A	1.65	2.45	2.90	2.75	268		
					MIL-135A1	1.65	2.45	2.70	2.60	268			
B	33001-4021	33001-5021	7U5T-14474-UA	SILVER**	14	MIL-123A	1.65	2.45	2.90	2.75	268		
						MIL-135A1	1.65	2.45	2.70	2.60	268		
					16	MIL-123A	1.35	2.45	2.40	2.60	222		
	33001-4022	33001-5022	7U5T-14474-PA	SILVER**	18	MIL-123A	1.25	2.15	2.00	2.30	157		
						SAE J1128 (IGXL)	1.25	2.15	2.40	2.60	158		
					20	MIL-123A	1.15	2.15	1.90	2.10	128		
	33001-4023	33001-5023	7U5T-14474-NA	SILVER**		100mm ²	MIL-126A1	1.25	2.15	1.95	2.10	142	
						150mm ²	MIL-126A1	1.40	2.45	2.60	2.60	257	
						100mm ²	MIL-126A1	1.30	2.15	2.00	2.30	211	
	33001-4022	33001-5022	7U5T-14										

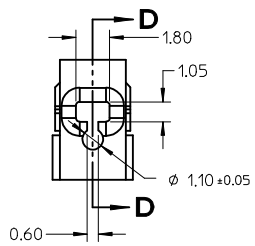
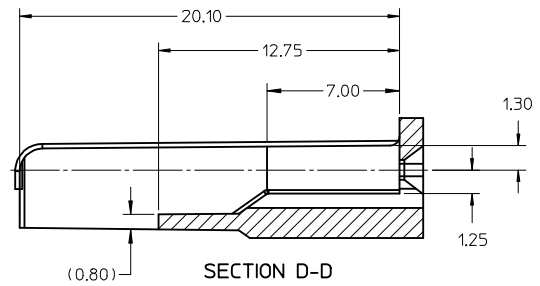
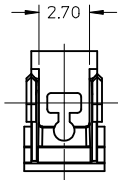

- NOTES: UNLESS OTHERWISE SPECIFIED
1. TOLERANCES: LINEAR ± 0.10
ANGULAR $\pm 3^\circ$
 2. ALL DRAFT WITHIN TOLERANCE.
 3. MAX RADII ON ALL CORNERS SHOWN SHARP: 0.10
 4. MAX FLASH PERMISSIBLE: 0.1
 5. EJECTOR PIN MARKS PERMISSIBLE IF FLUSH TO 0.25 BELOW SURFACE.
 6. MATERIAL: HOUSING/FINGER SPECIFICATION ENGINEERED FOR MATERIAL WITH THE FOLLOWING PROPERTIES:
A. FLEXURAL MODULUS = 4,500 TO 9,400 MPa
PER ASTM TEST D790
B. ELONGATION AT YIELD = 2.3% OR BETTER
PER ASTM TEST D638 TYPE V
 7. CAVITY SPEC FOR USE ONLY WITH MOLEX RECEPTACLE TERMINAL PART NUMBERS SPECIFIED ELSEWHERE ON THIS DRAWING

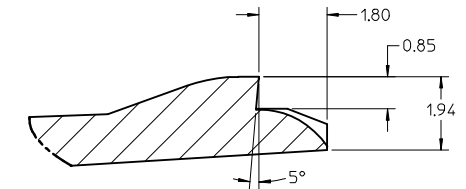
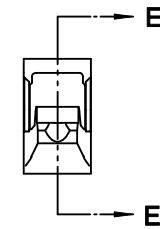
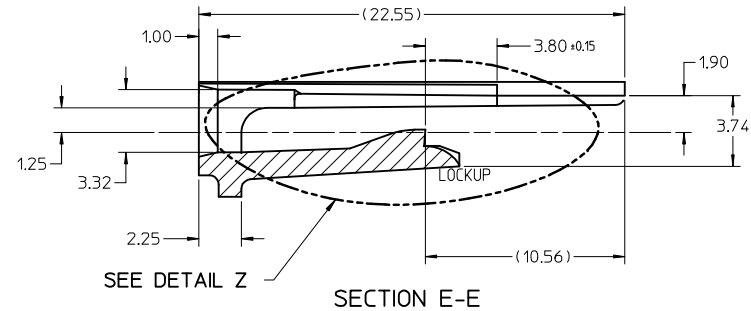
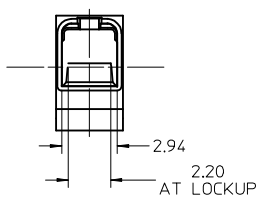

DETAIL Z
SCALE 20:1

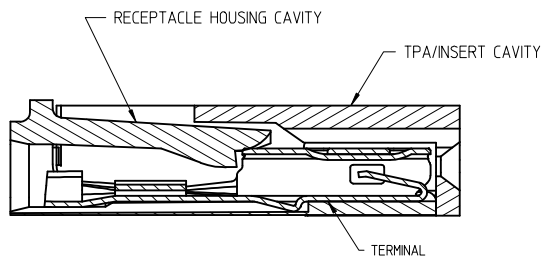

SECTION F-F

RECEPTACLE CAVITY ASSEMBLED VIEWS
FOR SMALL POLARIZATION RIB APPLICATIONS
FIG. 1

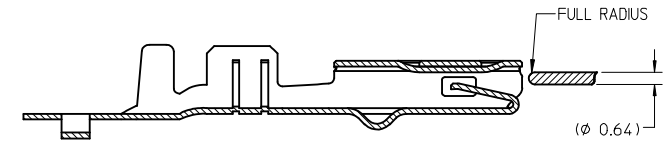
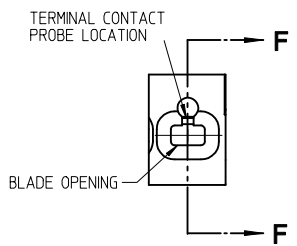

SECTION D-D
FOR LARGE POLARIZATION RIB APPLICATIONS
FIG. 2

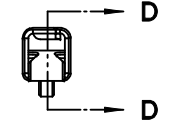

PROBING DOWN THE THROAT MUST USE THIS TERMINAL PROBE

PROBE PIN DETAILS:
MANUFACTURER: LONE STAR INDUSTRIAL
PART NUMBER: LS054R-403-N-4.6
PIN DIAMETER: 0.025 IN (0.64mm)
TIP SHAPE: SPHERICAL
TEL: 915-779-7255

PREFERRED PROBING LOCATION IS NOT ON SPRING MEMBER

IF ELECTRICAL CONTINUITY PROBE TOUCHES SPRING MEMBER USE PROBING AS SHOWN IN FIG. 2

REV	DESCRIPTION	DATE	BY	CHKD	APPD
B1	ENTER DESCRIPTION	2009/08/18	L. PULLIAM	A. DHIR	B. MOSER
	EC NO: JAU2010-0107	2009/08/19			
	DRWN: KFERGUSON	2009/08/19			
	CHKD: A. DHIR	2009/08/20			
	APPD: B. MOSER	2009/08/20			

QUALITY SYMBOLS

◀=0

▽=0

GENERAL TOLERANCES (UNLESS SPECIFIED)

	mm	INCH
4 PLACES	± 0.10	± 0.004
3 PLACES	± 0.005	± 0.0002
2 PLACES	± 0.10	± 0.004
1 PLACE	± 0.3	± 0.012

ANGULAR $\pm 3^\circ$

DIMENSION STYLE
MM ONLY

DRAWN BY	DATE
L. PULLIAM	2005/06/21
CHECKED BY	DATE
A. DHIR	2005/06/21
APPROVED BY	DATE
B. MOSER	2005/06/22

SCALE
5:1

DESIGN UNITS
METRIC

THIRD ANGLE PROJECTION

MX150
RECEPTACLE TERMINAL



MOLEX INCORPORATED

MATERIAL NO.
SEE TABLE

DOCUMENT NO.
SD-33012-002

SHEET NO.
4 OF 5

THIS DRAWING CONTAINS INFORMATION THAT IS PROPRIETARY TO MOLEX INCORPORATED AND SHOULD NOT BE USED WITHOUT WRITTEN PERMISSION

TABLE 2 - TERMINAL GRIP/CRIMP TOOL DIM. REFERENCE TABLE

J	SUPPLIER PART NO.		FORD PART NO.	PLATING (STAMPING)	WIRE APPLICATION		WIRE SPECIFICATION		A±0.30	B±0.30	C±0.30	D±0.30	E±0.005	F±0.005	G±0.005	J±0.005	K±0.005	M±0.005	N±0.005	P±0.005	R±0.005	U±0.005	V±0.005	
	SMALL POLARIZATION RIB	RIGHT PAYOFF			LEFT PAYOFF	SAE	METRIC																	
J	33012-2001	33012-3001	7C3T-1474-EA	TIN	14	2.0	MIL-123A JASO D 611 (AVSS)	3.9	4.4	1.7	1.6	12.82	0.6	1.19	7.05	13.12	1.35	6.91	2.44	6.11	2.72	1.40		
					14	-	MIL-135A1	3.9	4.4	1.7	1.6	12.82	0.6	1.19	7.05	12.96	1.28	6.51	2.44	6.11	2.52	1.30		
I	33012-2002	33012-3002	7C3T-1474-DA	TIN	16	1.5	MIL-123A/MIL-126A1	3.9	4.4	1.7	1.6	12.82	0.6	1.19	7.05	12.96	1.28	6.51	2.44	6.11	2.52	1.30		
					18	1.0	MIL-123A/MIL-126A1	3.3	3.1	1.3	1.4	12.46	0.57	0.99	6.52	12.65	1.13	6.46	2.14	1.93	2.23	1.15		
H	33012-2003	33012-3003	7C3T-1474-CA	TIN	18	-	SAE J1128 (IGXL)	3.3	3.1	1.3	1.4	12.46	0.57	0.99	6.52	12.96	1.28	6.51	2.14	1.93	2.52	1.30		
					20	0.75	MIL-123A/MIL-126A1	3.3	3.1	1.3	1.4	12.46	0.57	0.99	6.52	12.42	1.03	6.36	2.14	1.93	2.04	1.05		
G	33012-2003*	33012-3003*	7C3T-1474-CA*	TIN	22	-	SAE J1128 (IGXL)	3.3	3.1	1.3	1.4	12.46	0.57	0.99	6.52	12.65	1.13	6.46	2.14	1.93	2.23	1.15		
					20	0.5	MIL-123A/MIL-126A1 JASO D 611 (AVSS)	2.5	2.6	0.9	1.0	11.97	0.42	0.72	6.57	12.24	0.93	6.31	1.60	1.44	1.84	0.95		
F	33012-2003*	33012-3003*	7C3T-1474-CA*	TIN	-	0.35	WSK-14348-A2	2.5	2.6	0.9	1.0	11.97	0.42	0.72	6.57	12.24	0.93	6.31	1.60	1.44	1.84	0.95		
					14	2.0	MIL-123A JASO D 611 (AVSS)	3.9	4.4	1.7	1.6	12.82	0.6	1.19	7.05	13.12	1.35	6.91	2.44	6.11	2.72	1.40		
E	33001-2003	33001-3003	7C3T-1474-HA	GOLD	14	-	MIL-135A1	3.9	4.4	1.7	1.6	12.82	0.6	1.19	7.05	12.96	1.28	6.51	2.44	6.11	2.52	1.30		
					16	1.5	MIL-123A/MIL-126A1	3.9	4.4	1.7	1.6	12.82	0.6	1.19	7.05	12.96	1.28	6.51	2.44	6.11	2.52	1.30		
D	33001-2004	33001-3004	7C3T-1474-GA	GOLD	18	1.0	MIL-123A/MIL-126A1	3.3	3.1	1.3	1.4	12.46	0.57	0.99	6.52	12.65	1.13	6.46	2.14	1.93	2.23	1.15		
					18	-	SAE J1128 (IGXL)	3.3	3.1	1.3	1.4	12.46	0.57	0.99	6.52	12.96	1.28	6.51	2.14	1.93	2.52	1.30		
C	33001-2005*	33001-3005*	7C3T-1474-FA*	GOLD	20	0.75	MIL-123A/MIL-126A1	3.3	3.1	1.3	1.4	12.46	0.57	0.99	6.52	12.42	1.03	6.36	2.14	1.93	2.04	1.05		
					20	-	SAE J1128 (IGXL)	3.3	3.1	1.3	1.4	12.46	0.57	0.99	6.52	12.65	1.13	6.46	2.14	1.93	2.23	1.15		
B	33001-2005*	33001-3005*	7C3T-1474-FA*	GOLD	22	0.5	MIL-123A/MIL-126A1 JASO D 611 (AVSS)	2.5	2.6	0.9	1.0	11.97	0.42	0.72	6.57	12.24	0.93	6.31	1.60	1.44	1.84	0.95		
					-	0.35	WSK-14348-A2	2.5	2.6	0.9	1.0	11.97	0.42	0.72	6.57	12.24	0.93	6.31	1.60	1.44	1.84	0.95		
A	33001-4001	33001-5001	7U5T-1474-UA	SILVER	14	2.0	MIL-123A JASO D 611 (AVSS)	3.9	4.4	1.7	1.6	12.82	0.6	1.19	7.05	13.12	1.35	6.91	2.44	6.11	2.72	1.40		
					14	-	MIL-135A1	3.9	4.4	1.7	1.6	12.82	0.6	1.19	7.05	12.96	1.28	6.51	2.44	6.11	2.52	1.30		
Z	33001-4002	33001-5002	7U5T-1474-TA	SILVER	16	1.5	MIL-123A/MIL-126A1	3.9	4.4	1.7	1.6	12.82	0.6	1.19	7.05	12.96	1.28	6.51	2.44	6.11	2.52	1.30		
					18	1.0	MIL-123A/MIL-126A1	3.3	3.1	1.3	1.4	12.46	0.57	0.99	6.52	12.65	1.13	6.46	2.14	1.93	2.23	1.15		
Y	33001-4003	33001-5003	7U5T-1474-SA	SILVER	18	-	SAE J1128 (IGXL)	3.3	3.1	1.3	1.4	12.46	0.57	0.99	6.52	12.96	1.28	6.51	2.14	1.93	2.52	1.30		
					20	0.75	MIL-123A/MIL-126A1	3.3	3.1	1.3	1.4	12.46	0.57	0.99	6.52	12.42	1.03	6.36	2.14	1.93	2.04	1.05		
X	33001-4003*	33001-5003*	7U5T-1474-SA*	SILVER	20	-	SAE J1128 (IGXL)	3.3	3.1	1.3	1.4	12.46	0.57	0.99	6.52	12.65	1.13	6.46	2.14	1.93	2.23	1.15		
					22	0.5	MIL-123A/MIL-126A1 JASO D 611 (AVSS)	2.5	2.6	0.9	1.0	11.97	0.42	0.72	6.57	12.24	0.93	6.31	1.60	1.44	1.84	0.95		
W	33001-4003*	33001-5003*	7U5T-1474-SA*	SILVER	-	0.35	WSK-14348-A2	2.5	2.6	0.9	1.0	11.97	0.42	0.72	6.57	12.24	0.93	6.31	1.60	1.44	1.84	0.95		
					14	2.0	MIL-123A JASO D 611 (AVSS)	3.9	4.4	1.7	1.6	12.82	0.6	1.19	7.05	13.12	1.35	6.91	2.44	6.11	2.72	1.40		
V	33012-2021	33012-3021	7C3T-1474-LA	TIN	14	2.0	MIL-123A JASO D 611 (AVSS)	3.9	4.4	1.7	1.6	12.82	0.6	1.19	7.05	13.12	1.35	6.91	2.44	6.11	2.72	1.40		
					14	-	MIL-135A1	3.9	4.4	1.7	1.6	12.82	0.6	1.19	7.05	12.96	1.28	6.51	2.44	6.11	2.52	1.30		
U	33012-2022	33012-3022	7C3T-1474-KA	TIN	16	1.5	MIL-123A/MIL-126A1	3.9	4.4	1.7	1.6	12.82	0.6	1.19	7.05	12.96	1.28	6.51	2.44	6.11	2.52	1.30		
					18	1.0	MIL-123A/MIL-126A1	3.3	3.1	1.3	1.4	12.46	0.57	0.99	6.52	12.65	1.13	6.46	2.14	1.93	2.23	1.15		
T	33012-2023	33012-3023	7C3T-1474-JA	TIN	18	-	SAE J1128 (IGXL)	3.3	3.1	1.3	1.4	12.46	0.57	0.99	6.52	12.96	1.28	6.51	2.14	1.93	2.52	1.30		
					20	0.75	MIL-123A/MIL-126A1	3.3	3.1	1.3	1.4	12.46	0.57	0.99	6.52	12.42	1.03	6.36	2.14	1.93	2.04	1.05		
S	33012-2023*	33012-3023*	7C3T-1474-JA*	TIN	20	-	SAE J1128 (IGXL)	3.3	3.1	1.3	1.4	12.46	0.57	0.99	6.52	12.65	1.13	6.46	2.14	1.93	2.23	1.15		
					22	0.5	MIL-123A/MIL-126A1 JASO D 611 (AVSS)	2.5	2.6	0.9	1.0	11.97	0.42	0.72	6.57	12.24	0.93	6.31	1.60	1.44	1.84	0.95		
R	33001-2021	33001-3021	7C3T-1474-PA	GOLD	14	2.0	MIL-123A JASO D 611 (AVSS)	3.9	4.4	1.7	1.6	12.82	0.6	1.19	7.05	13.12	1.35	6.91	2.44	6.11	2.72	1.40		
					14	-	MIL-135A1	3.9	4.4	1.7	1.6	12.82	0.6	1.19	7.05	12.96	1.28	6.51	2.44	6.11	2.52	1.30		
Q	33001-2022	33001-3022	7C3T-1474-NA	GOLD	16	1.5	MIL-123A/MIL-126A1	3.9	4.4	1.7	1.6	12.82	0.6	1.19	7.05	12.96	1.28	6.51	2.44	6.11	2.52	1.30		
					18	1.0	MIL-123A/MIL-126A1	3.3	3.1	1.3	1.4	12.46	0.57	0.99	6.52	12.65	1.13	6.46	2.14	1.93	2.23	1.15		
P	33001-2023	33001-3023	7C3T-1474-MA	GOLD	18	-	SAE J1128 (IGXL)	3.3	3.1	1.3	1.4	12.46	0.57	0.99	6.52	12.96	1.28	6.51	2.14	1.93	2.52	1.30		
					20	0.75	MIL-123A/MIL-126A1	3.3	3.1	1.3	1.4	12.46	0.57	0.99	6.52	12.42	1.03	6.36	2.14	1.93	2.04	1.05		
O	33001-2023*	33001-3023*	7C3T-1474-MA*	GOLD	20	-	SAE J1128 (IGXL)	3.3	3.1	1.3	1.4	12.46	0.57	0.99	6.52	12.65	1.13	6.46	2.14	1.93	2.23	1.15		
					22	0.5	MIL-123A/MIL-126A1 JASO D 611 (AVSS)	2.5	2.6	0.9	1.0	11.97	0.42	0.72	6.57	12.24	0.93	6.31	1.60	1.44	1.84	0.95		
N	33001-4021	33001-5021	7U5T-1474-RA	SILVER	14	2.0	MIL-123A JASO D 611 (AVSS)	3.9	4.4	1.7	1.6	12.82	0.6	1.19	7.05	13.12	1.35	6.91	2.44	6.11	2.72	1.40		
					14	-	MIL-135A1	3.9	4.4	1.7	1.6	12.82	0.6	1.19	7.05	12.96	1.28	6.51	2.44	6.11	2.52	1.30		
M	33001-4022	33001-5022	7U5T-1474-PA	SILVER	16	1.5	MIL-123A/MIL-126A1	3.9	4.4	1.7	1.6	12.82	0.6	1.19	7.05	12.96	1.28	6.51	2.44	6.11	2.52	1.30		
					18	1.0	MIL-123A/MIL-126A1	3.3	3.1	1.3	1.4	12.46	0.57	0.99	6.52	12.65	1.13	6.46	2.14	1.93	2.23	1.15		
L	33001-4022	33001-5022	7U5T-1474-PA	SILVER	18	-	SAE J1128 (IGXL)	3.3	3.1															