



SRIX512

13.56MHz Short Range Contactless Memory Chip with 512 bit EEPROM, Anti-Collision and Anti-Clone Functions

FEATURES SUMMARY

- ISO 14443 - 2 Type B Air Interface Compliant
- ISO 14443 - 3 Type B Frame Format Compliant
- 13.56MHz Carrier Frequency
- 847kHz Sub-carrier Frequency
- 106 kbit/second Data Transfer
- France Telecom Proprietary Anti-Clone Function
- 8 bit Chip_ID based anticollision system
- 2 Count-Down Binary Counters with automated anti-tearing protection
- 64-bit Unique Identifier
- 512-bit EEPROM with Write Protect Feature
- READ BLOCK and WRITE BLOCK (32 Bits)
- Internal Tuning Capacitor
- 1million ERASE/WRITE Cycles
- 40-Year Data Retention
- Self-Timed Programming Cycle
- 5ms Typical Programming Time

Figure 1. Delivery Forms

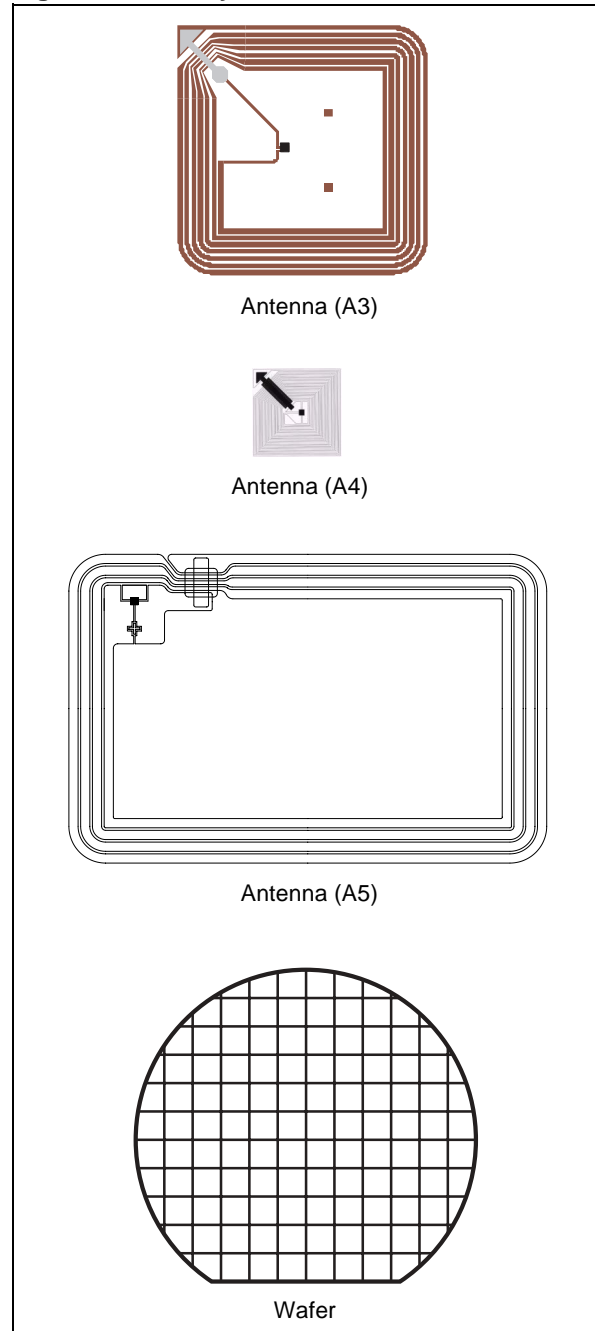

TABLE OF CONTENTS

FEATURES SUMMARY 1

 Figure 1. Delivery Forms. 1

SUMMARY DESCRIPTION. 6

 Figure 2. Logic Diagram 6

 Table 1. Signal Names 6

 Figure 3. Die Floor Plan 6

SIGNAL DESCRIPTION 6

 AC1, AC0. 6

DATA TRANSFER 7

Input Data Transfer from the Reader to the SRIX512 (Request Frame) 7

 Figure 4. 10% ASK Modulation of the Received Wave. 7

 Character Transmission Format for Request Frame 7

 Figure 5. SRIX512 Request Frame Character Format 7

 Table 2. Bit Description 7

 Request Start Of Frame 8

 Figure 6. Request Start Of Frame. 8

 Request End Of Frame 8

 Figure 7. Request End Of Frame 8

Output Data Transfer from the SRIX512 to the Reader (Answer Frame) 8

 Figure 8. Wave Transmitted using BPSK Sub-carrier Modulation 8

 Character Transmission Format for Answer Frame 9

 Answer Start Of Frame 9

 Figure 9. Answer Start Of Frame 9

 Answer End Of Frame. 9

 Figure 10. Answer End Of Frame. 9

Transmission Frame 9

 Figure 11. Example of a Complete Transmission Frame 9

CRC. 10

 Figure 12. CRC Transmission Rules 10

MEMORY MAPPING 11

 Figure 13. SRIX512 Memory Mapping 11

Resettable OTP Area 12

 Figure 14. Resettable OTP Area (addresses 0 to 4) 12

 Figure 15. WRITE_BLOCK Update in Standard Mode (Binary Format). 12

 Figure 16. WRITE_BLOCK Update in Reload Mode (Binary Format) 12

32-bit Binary Counters 13

 Figure 17. Binary Counter (addresses 5 to 6) 13

 Figure 18. Count Down Example (Binary Format) 13

EEPROM Area 14



Figure 19.EEPROM (Addresses 7 to 15)	14
System Area	15
Figure 20.System Area	15
OTP_Lock_Reg	15
Fixed Chip_ID (Option)	15
SRIX512 OPERATION	16
SRIX512 STATES	16
POWER-OFF State	16
READY State	16
INVENTORY State	16
SELECTED State	16
DESELECTED State	16
DEACTIVATED State	16
Figure 21.State Transition Diagram	17
ANTI-COLLISION	18
Figure 22.SRIX512 Chip_ID Description	18
Figure 23.Description of a Possible Anti-Collision Sequence	19
Description of an Anti-Collision Sequence	20
Table 3. Standard Anti-Collision Sequence	20
Figure 24.Example of an Anti-Collision Sequence	21
ANTI-CLONE FUNCTION	22
SRIX512 COMMANDS	22
Table 4. Command Code	22
INITIATE() Command	23
Figure 25.INITIATE Request Format	23
Figure 26.INITIATE Response Format	23
Figure 27.INITIATE Frame Exchange Between Reader and SRIX512	23
PCALL16() Command	24
Figure 28.PCALL16 Request Format	24
Figure 29.PCALL16 Response Format	24
Figure 30.PCALL16 Frame Exchange Between Reader and SRIX512	24
SLOT_MARKER(SN) Command	25
Figure 31.SLOT_MARKER Request Format	25
Figure 32.SLOT_MARKER Response Format	25
Figure 33.SLOT_MARKER Frame Exchange Between Reader and SRIX512	25
SELECT(Chip_ID) Command	26
Figure 34.SELECT Request Format	26
Figure 35.SELECT Response Format	26
Figure 36.SELECT Frame Exchange Between Reader and SRIX512	26
COMPLETION() Command	27
Figure 37.COMPLETION Request Format	27

Figure 38.COMPLETION Response Format	27
Figure 39.COMPLETION Frame Exchange Between Reader and SRIX512	27
RESET_TO_INVENTORY() Command	28
Figure 40.RESET_TO_INVENTORY Request Format	28
Figure 41.RESET_TO_INVENTORY Response Format	28
Figure 42.RESET_TO_INVENTORY Frame Exchange Between Reader and SRIX512	28
READ_BLOCK(Addr) Command	29
Figure 43.READ_BLOCK Request Format	29
Figure 44.READ_BLOCK Response Format	29
Figure 45.READ_BLOCK Frame Exchange Between Reader and SRIX512	29
WRITE_BLOCK (Addr, Data) Command	30
Figure 46.WRITE_BLOCK Request Format	30
Figure 47.WRITE_BLOCK Response Format	30
Figure 48.WRITE_BLOCK Frame Exchange Between Reader and SRIX512	30
GET_UID() Command	31
Figure 49.GET_UID Request Format	31
Figure 50.GET_UID Response Format	31
Figure 51.GET_UID Frame Exchange Between Reader and SRIX512	31
Power-On State	31
MAXIMUM RATING.	32
Table 5. Absolute Maximum Ratings	32
DC AND AC PARAMETERS.	33
Table 6. Operating Conditions	33
Table 7. DC Characteristics	33
Table 8. AC Characteristics	33
Figure 52.SRIX512 Synchronous Timing, Transmit and Receive	34
PACKAGE MECHANICAL	35
Figure 53.A3 Antenna Specification	35
Table 9. A3 Antenna Specification	35
Figure 54.A4 Antenna Specification	36
Table 10. A4 Antenna Specification	36
Figure 55.A5 Antenna Specification	37
Table 11. A5 Antenna Specification	37
PART NUMBERING	38
Table 12. Ordering Information Scheme	38
APPENDIX A.ISO14443 TYPE B CRC CALCULATION	39
APPENDIX B.SRIX512 COMMAND BRIEF	40
Figure 56.INITIATE Frame Exchange Between Reader and SRIX512	40
Figure 57.PCALL16 Frame Exchange Between Reader and SRIX512	40
Figure 58.SLOT_MARKER Frame Exchange Between Reader and SRIX512	40

Figure 59.SELECT Frame Exchange Between Reader and SRIX512 40
Figure 60.COMPLETION Frame Exchange Between Reader and SRIX512 40
Figure 61.RESET_TO_INVENTORY Frame Exchange Between Reader and SRIX512 41
Figure 62.READ_BLOCK Frame Exchange Between Reader and SRIX512 41
Figure 63.WRITE_BLOCK Frame Exchange Between Reader and SRIX512 41
Figure 64.GET_UID Frame Exchange Between Reader and SRIX512 41

REVISION HISTORY..... 42

Table 13. Document Revision History 42

SUMMARY DESCRIPTION

The SRIX512 is a contactless memory, powered by an externally transmitted radio wave. It contains a 512-bit user EEPROM fabricated with STMicroelectronics CMOS technology. The memory is organized as 16 blocks of 32 bits. The SRIX512 is accessed via the 13.56MHz carrier. Incoming data are demodulated and decoded from the received Amplitude Shift Keying (ASK) modulation signal and outgoing data are generated by load variation using Bit Phase Shift Keying (BPSK) coding of a 847kHz sub-carrier. The received ASK wave is 10% modulated. The Data transfer rate between the SRIX512 and the reader is 106kbit/s in both reception and emission modes.

The SRIX512 follows the ISO 14443 part 2 type B recommendation for the radio-frequency power and signal interface.

Figure 2. Logic Diagram

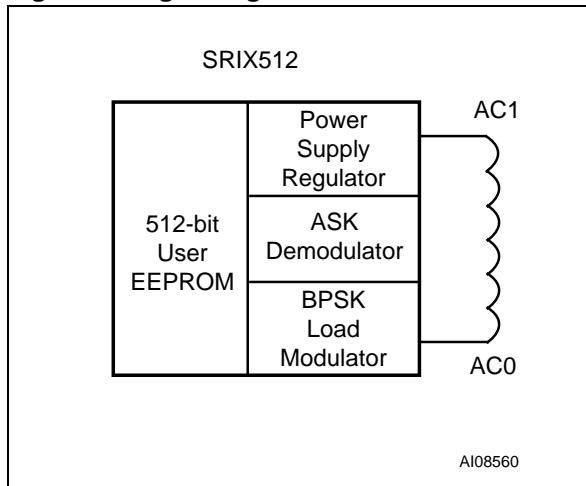

The SRIX512 is specifically designed for short range applications that need secure and re-usable products. The SRIX512 includes an anti-collision mechanism that allows it to detect and select tags present at the same time within range of the reader. The anti-collision is based on a probabilistic scanning method using slot markers. The SRIX512 provides an anti-clone function which allows its authentication. Using the STMicroelectronics single chip coupler, CRX14, it is easy to design a reader with the authentication capability and to build a system with a high level of security.

Table 1. Signal Names

AC1	Antenna Coil
AC0	Antenna Coil

The SRIX512 contactless EEPROM can be randomly read and written in block mode (each block containing 32 bits). The instruction set includes the following ten commands:

- READ_BLOCK
- WRITE_BLOCK
- INITIATE
- PCALL16
- SLOT_MARKER
- SELECT
- COMPLETION
- RESET_TO_INVENTORY
- AUTHENTICATE
- GET_UID

The SRIX512 memory is organized in three areas, as described in Figure 13.. The first area is a resettable OTP (one time programmable) area in which bits can only be switched from 1 to 0. Using a special command, it is possible to erase all bits of this area to 1. The second area provides two 32-bit binary counters which can only be decremented from FFFFFFFh to 00000000h, and gives a capacity of 4,294,967,296 units per counter. The last area is the EEPROM memory. It is accessible by block of 32 bits and includes an auto-erase cycle during each WRITE_BLOCK command.

Figure 3. Die Floor Plan

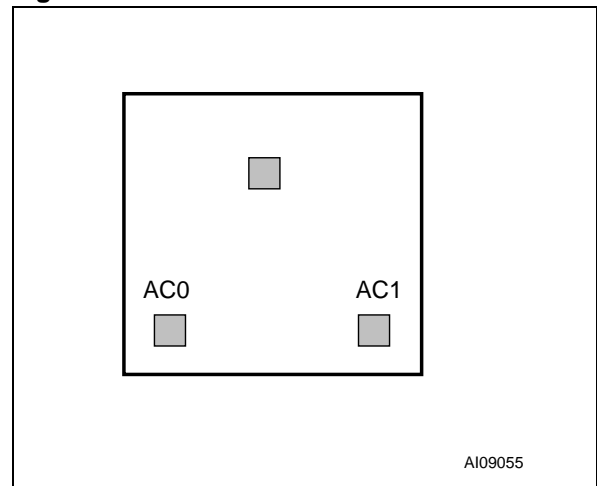

SIGNAL DESCRIPTION

AC1, AC0. The pads for the Antenna Coil. AC1 and AC0 must be directly bonded to the antenna.

DATA TRANSFER

Input Data Transfer from the Reader to the SRIX512 (Request Frame)

The reader must generate a 13.56MHz sinusoidal carrier frequency at its antenna, with enough energy to “remote-power” the memory. The energy received at the SRIX512’s antenna is transformed into a Supply Voltage by a regulator, and into data

bits by the ASK demodulator. For the SRIX512 to decode correctly the information it receives, the reader must 10% amplitude-modulate the 13.56MHz wave before sending it to the SRIX512. This is represented in Figure 4.. The data transfer rate is 106 kbits/s.

Figure 4. 10% ASK Modulation of the Received Wave

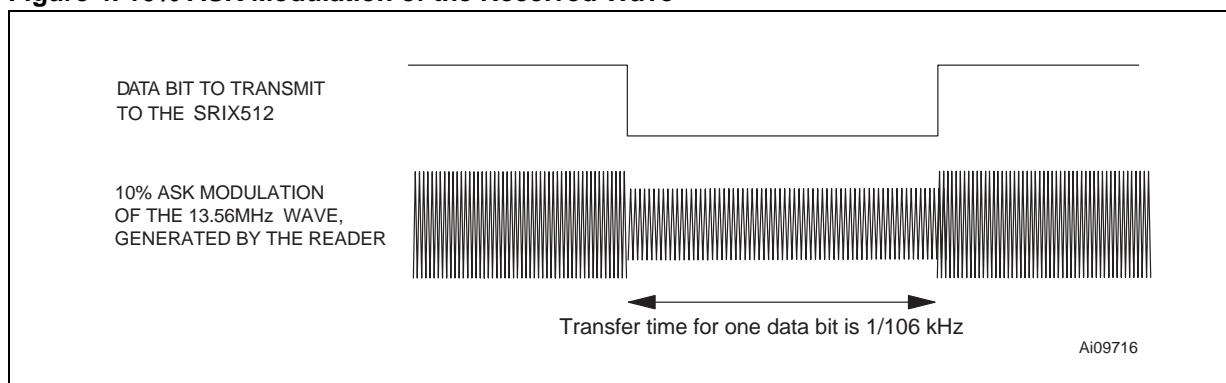

Character Transmission Format for Request Frame. The SRIX512 transmits and receives data bytes as 10-bit characters, with the least significant bit (b_0) transmitted first, as shown in Figure 5.. Each bit duration, an ETU (Elementary Time Unit), is equal to $9.44\mu\text{s}$ ($1/106\text{kHz}$).

These characters, framed by a Start Of Frame (SOF) and an End Of Frame (EOF), are put to-

gether to form a Command Frame as shown in Figure 11.. A frame includes an SOF, commands, addresses, data, a CRC and an EOF as defined in the ISO14443-3 type B Standard. If an error is detected during data transfer, the SRIX512 does not execute the command, but it does not generate an error frame.

Figure 5. SRIX512 Request Frame Character Format

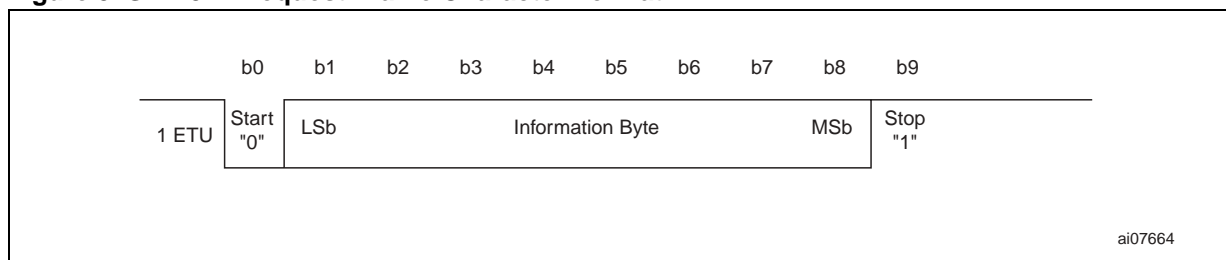

Table 2. Bit Description

Bit	Description	Value
b_0	Start bit used to synchronize the transmission	$b_0 = 0$
b_1 to b_8	Information Byte (command, address or data)	The information byte is sent with the least significant bit first
b_9	Stop bit used to indicate the end of a character	$b_9 = 1$

Request Start Of Frame. The SOF described in Figure 6. is composed of:

- one falling edge,
- followed by 10 ETUs at logic-0,
- followed by a single rising edge,
- followed by at least 2 ETUs (and at most 3) at logic-1.

Figure 6. Request Start Of Frame

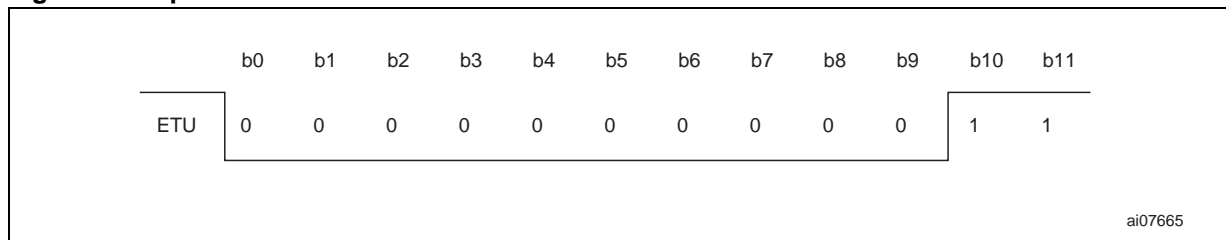

Request End Of Frame. The EOF shown in Figure 7. is composed of:

- one falling edge,
- followed by 10 ETUs at logic-0,
- followed by a single rising edge.

Figure 7. Request End Of Frame

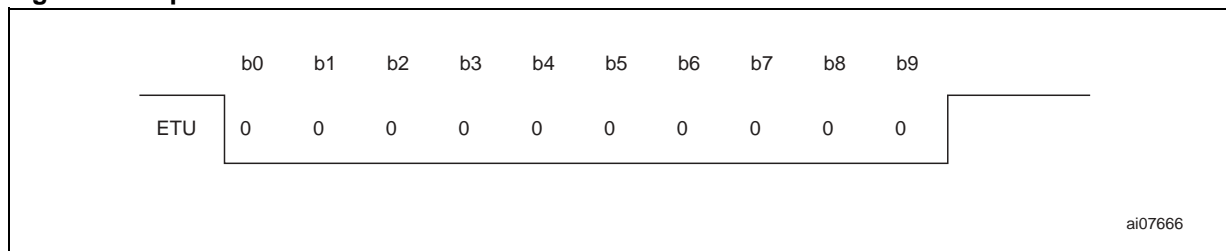

Output Data Transfer from the SRIX512 to the Reader (Answer Frame)

The data bits issued by the SRIX512 use retro-modulation. Retro-modulation is obtained by modifying the SRIX512 current consumption at the antenna (load modulation). The load modulation causes a variation at the reader antenna by induc-

tive coupling. With appropriate detector circuitry, the reader is able to pick up information from the SRIX512. To improve load-modulation detection, data is transmitted using a BPSK encoded, 847kHz sub-carrier frequency f_s as shown in Figure 8., and as specified in the ISO14443-2 type B Standard.

Figure 8. Wave Transmitted using BPSK Sub-carrier Modulation

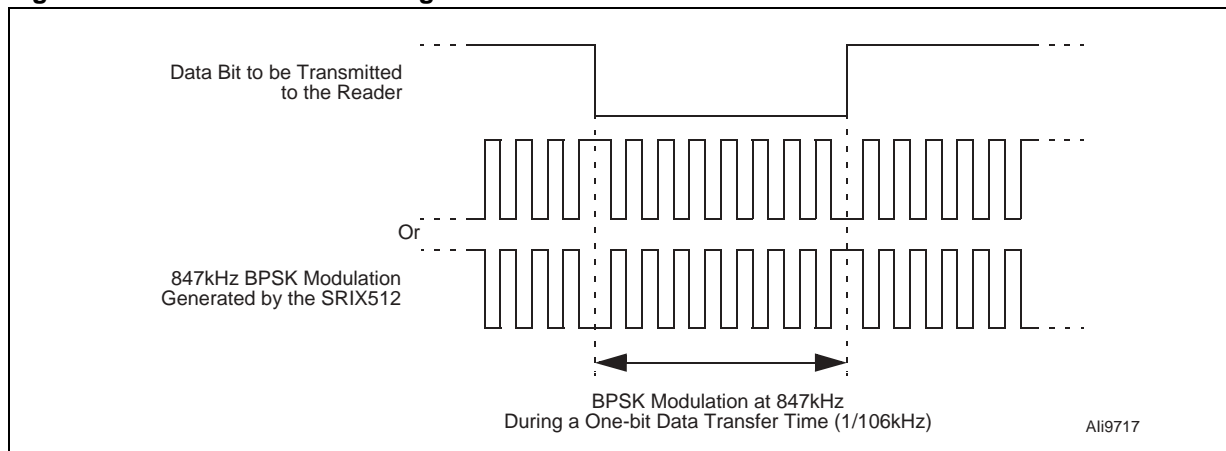

Character Transmission Format for Answer Frame. The character format is the same as for input data transfer (Figure 5.). The transmitted frames are made up of an SOF, data, a CRC and an EOF (Figure 11.). As with an input data transfer, if an error occurs, the reader does not issue an error code to the SRIX512, but it should be able to

detect it and manage the situation. The data transfer rate is 106 kbits/second.

Answer Start Of Frame. The SOF described in Figure 9. is composed of:

- followed by 10 ETUs at logic-0
- followed by 2 ETUs at logic-1

Figure 9. Answer Start Of Frame

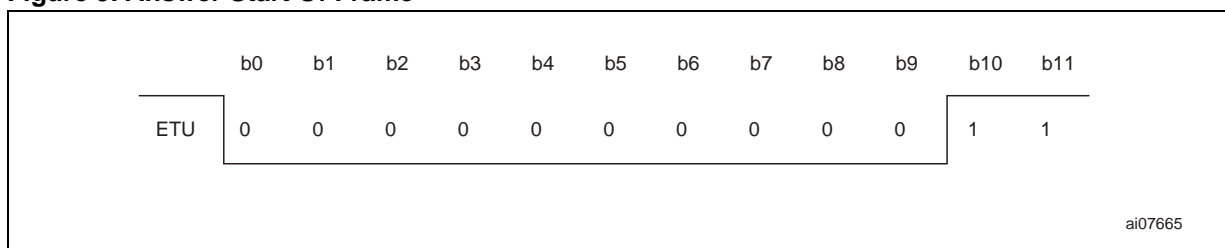

Answer End Of Frame. The EOF shown in Figure 10. is composed of:

- followed by 10 ETUs at logic-0,
- followed by 2 ETUs at logic-1.

Figure 10. Answer End Of Frame

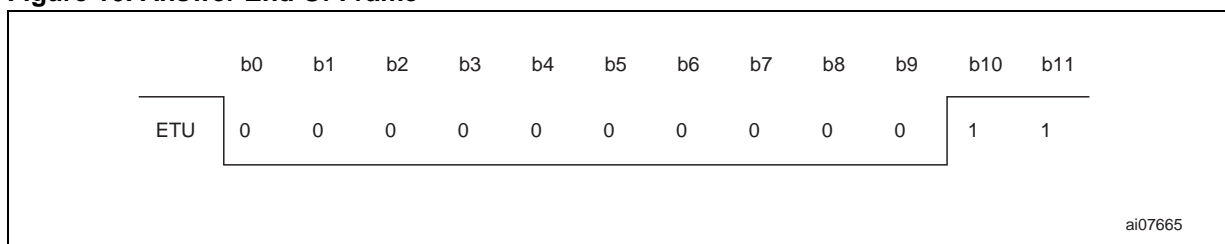

Transmission Frame

Between the Request data transfer and the Answer data transfer, all ASK and BPSK modulations are suspended for a minimum time of $t_0 = 128/f_s$. This delay allows the reader to switch from Transmission to Reception mode. It is repeated after each frame. After t_0 , the 13.56MHz carrier frequency is modulated by the SRIX512 at 847kHz

for a period of $t_1 = 128/f_s$ to allow the reader to synchronize. After t_1 , the first phase transition generated by the SRIX512 forms the start bit ('0') of the Answer SOF. After the falling edge of the Answer EOF, the reader waits a minimum time, t_2 , before sending a new Request Frame to the SRIX512.

Figure 11. Example of a Complete Transmission Frame

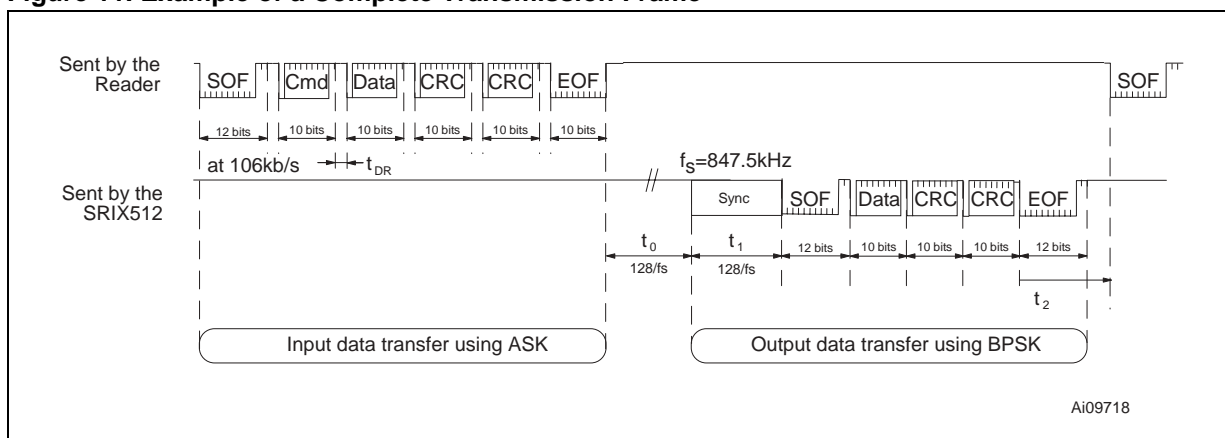

SRIX512

CRC

The 16-bit CRC used by the SRIX512 is generated in compliance with the ISO14443 type B recommendation. For further information, please see [APPENDIX A](#). The initial register contents are all 1s: FFFFh.

The two-byte CRC is present in every Request and in every Answer Frame, before the EOF. The CRC is calculated on all the bytes between SOF (not included) and the CRC field.

Upon reception of a Request from a reader, the SRIX512 verifies that the CRC value is valid. If it is invalid, the SRIX512 discards the frame and does not answer the reader.

Upon reception of an Answer from the SRIX512, the reader should verify the validity of the CRC. In case of error, the actions to be taken are the reader designer's responsibility.

The CRC is transmitted with the Least Significant Byte first and each byte is transmitted with the least significant bit first.

Figure 12. CRC Transmission Rules

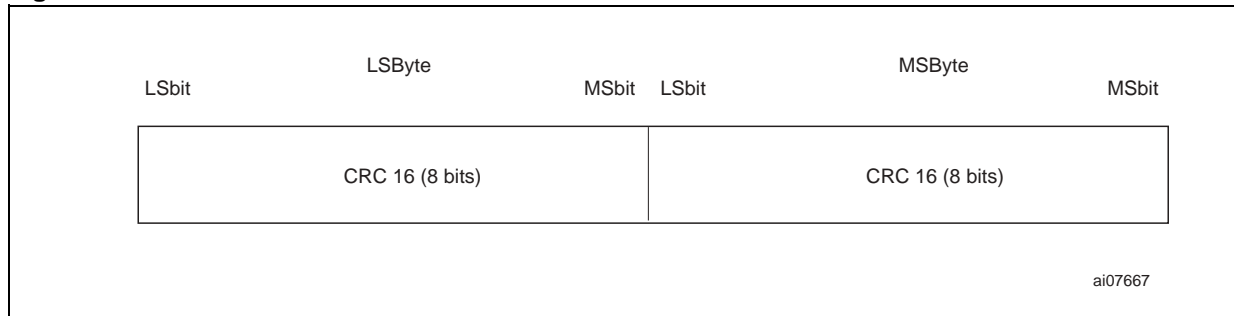

MEMORY MAPPING

The SRIX512 is organized as 16 blocks of 32 bits as shown in Figure 13.. All blocks are accessible by the READ_BLOCK command. Depending on

the write access, they can be updated by the WRITE_BLOCK command. A WRITE_BLOCK updates all the 32 bits of the block.

Figure 13. SRIX512 Memory Mapping

Block Addr	Msb b ₃₁	b ₂₄ b ₂₃	32 bits Block b ₁₆ b ₁₅	b ₈ b ₇	Lsb b ₀	Description
0			32 bits Boolean Area			Resettable OTP bits
1			32 bits Boolean Area			
2			32 bits Boolean Area			
3			32 bits Boolean Area			
4			32 bits Boolean Area			
5			32 bits binary counter			Count down Counter
6			32 bits binary counter			
7			User Area			Lockable EEPROM
8			User Area			
9			User Area			
10			User Area			
11			User Area			
12			User Area			
13			User Area			
14			User Area			
15			User Area			
255	OTP_Lock_Reg		ST Reserved		Fixed Chip_ID (Option)	System OTP bits
UID0	64 bits UID Area					ROM
UID1						

Resettable OTP Area

In this area contains five individual 32-bit Boolean Words (see Figure 14. for a map of the area). A WRITE_BLOCK command will not erase the previous contents of the block as the Write cycle is not preceded by an Auto Erase cycle. This feature can be used to reset selected bits from 1 to 0. All bits

previously at 0 remain unchanged. When the 32 bits of a block are all at 0, the block is empty, and cannot be updated any more. See Figure 15. and Figure 16. for examples of the result of the WRITE_BLOCK command in the resettable OTP area.

Figure 14. Resettable OTP Area (addresses 0 to 4)

Block Address	MSb b31	b24 b23	32-bit Block b16 b15	b8 b7	LSb b0	Description
0			32-bit Boolean Area			Resettable OTP Bit
1			32-bit Boolean Area			
2			32-bit Boolean Area			
3			32-bit Boolean Area			
4			32-bit Boolean Area			

ai07657

Figure 15. WRITE_BLOCK Update in Standard Mode (Binary Format)

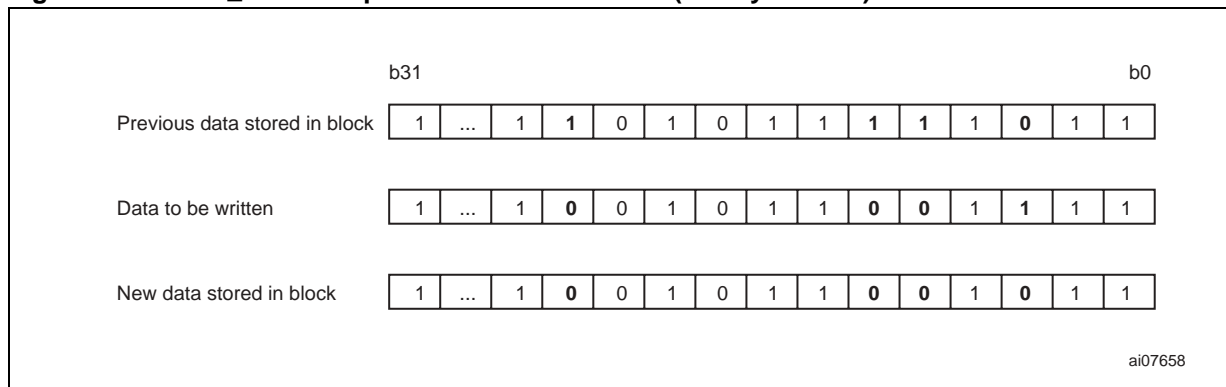

The five 32-bit blocks making up the Resettable OTP area can be erased in one go by adding an Auto Erase cycle to the WRITE_BLOCK command. An Auto Erase cycle is added each time the SRIX512 detects a Reload command. The Reload

command is implemented through a specific update of the 32-bit binary counter located at block address 6 (see “32-bit Binary Counters” for details).

Figure 16. WRITE_BLOCK Update in Reload Mode (Binary Format)

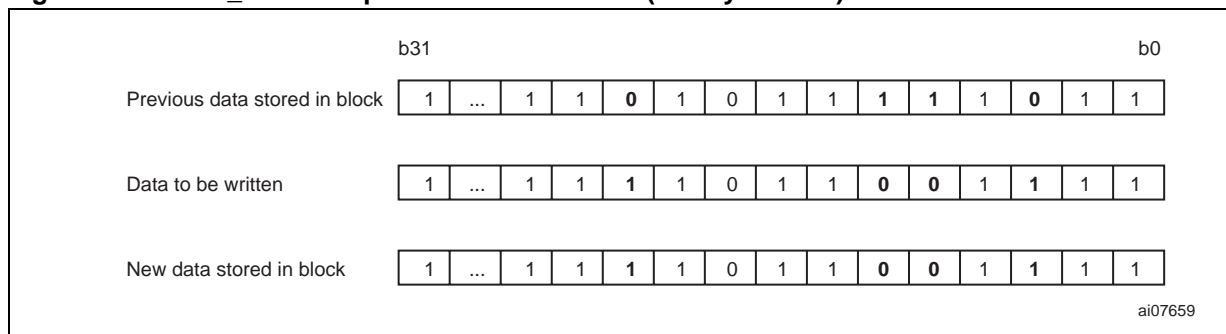

32-bit Binary Counters

The two 32-bit binary counters located at block addresses 5 and 6, respectively, are used to count down from 2^{32} (4096 million) to 0. The SRIX512 uses dedicated logic that only allows the update of a counter if the new value is lower than the previous one. This feature allows the application to count down by steps of 1 or more. The initial value in the counter is FFFFFFFFh. When the value displayed is 00000000h, the counter is empty and cannot be reloaded. The counter is updated by issuing the WRITE_BLOCK command to block ad-

dress 5 or 6, depending on which counter is to be updated. The WRITE_BLOCK command writes the new 32-bit value to the counter block address. Figure 18. shows examples of how the counters operate.

The counter programming cycles are protected by automated anti-tearing logic. This function allows the counter value to be protected in case of power down within the programming cycle. In case of power down, the counter value is not updated and the previous value continues to be stored.

Figure 17. Binary Counter (addresses 5 to 6)

Block Address	MSb b31	b24 b23	32-bit Block b16 b15	b8 b7	LSb b0	Description
5	32-bit Binary Counter					Count down Counter
6	32-bit Binary Counter					

ai07660

Figure 18. Count Down Example (Binary Format)

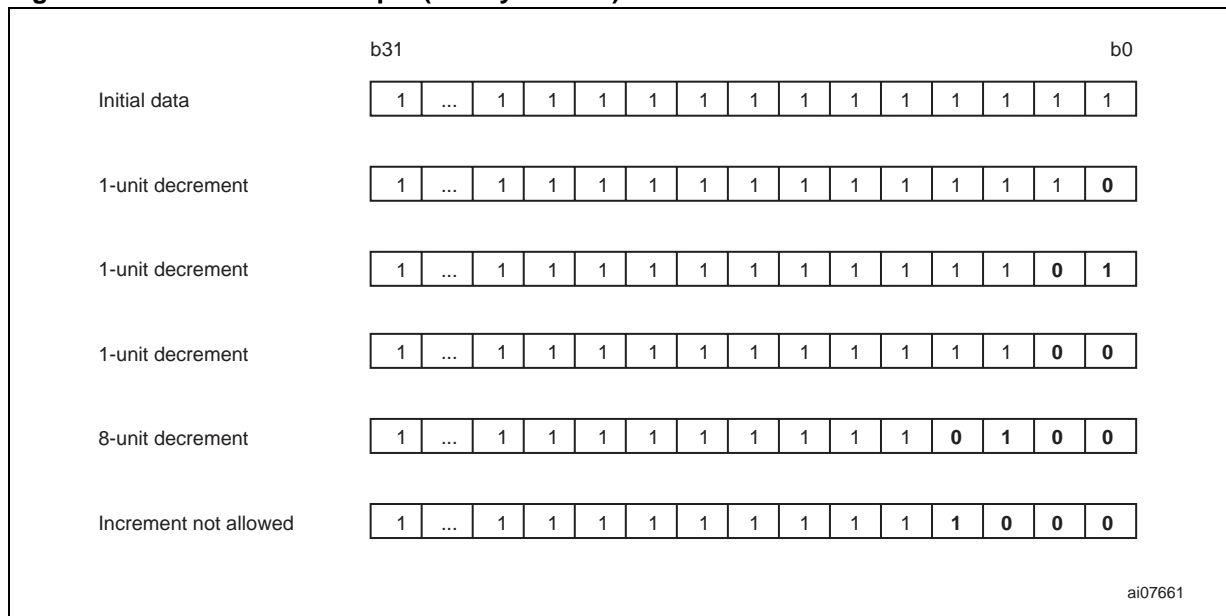

The counter with block address 6 controls the Reload command used to reset the resettable OTP area (addresses 0 to 4). Bits b₃₁ to b₂₁ act as an 11-bit Reload counter; whenever one of these 11 bits is updated, the SRIX512 detects the change and adds an Erase cycle to the WRITE_BLOCK

command for locations 0 to 4 (see the “Resettable OTP Area” paragraph). The Erase cycle remains active until a POWER-OFF or a SELECT command is issued. The SRIX512’s resettable OTP area can be reloaded up to 2,047 times ($2^{11}-1$).

SRIX512

EEPROM Area

The 9 blocks between addresses 7 and 15 are EEPROM blocks of 32 bits each (36 Bytes in total). (See [Figure 19](#). for a map of the area.) These blocks can be accessed using the READ_BLOCK and WRITE_BLOCK commands. The WRITE_BLOCK command for the EEPROM area

always includes an Auto-Erase cycle prior to the Write cycle.

Blocks 7 to 15 can be Write-protected. Write access is controlled by the 8 bits of the OTP_Lock_Reg located at block address 255 (see "[OTP_Lock_Reg](#)" for details). Once protected, these blocks (7 to 15) cannot be unprotected.

Figure 19. EEPROM (Addresses 7 to 15)

Block Address	MSb b31	b24 b23	32-bit Block b16 b15	b8 b7	LSb b0	Description
7			User Area			Lockable EEPROM
8			User Area			
9			User Area			
10			User Area			
11			User Area			
12			User Area			
13			User Area			
14			User Area			
15			User Area			

Ai09719

System Area

This area is used to modify the settings of the SRIX512. It contains 3 registers: OTP_Lock_Reg, Fixed Chip_ID and ST Reserved. See Figure 20. for a map of this area.

A WRITE_BLOCK command in this area will not erase the previous contents. Selected bits can thus be set from 1 to 0. All bits previously at 0 remain unchanged. Once all the 32 bits of a block are at 0, the block is empty and cannot be updated any more.

Figure 20. System Area

Block Address	32-bit Block				Description
	MSb b31	b24 b23	b16 b15	LSb b8 b7 b0	
255	OTP_Lock_Reg	ST Reserved		Fixed Chip_ID (Option)	OTP

ai07663

OTP_Lock_Reg. The 8 bits, b_{31} to b_{24} , of the System Area (block address 255) are used as OTP_Lock_Reg bits in the SRIX512. They control the Write access to the 9 EEPROM blocks with addresses 7 to 15 as follows:

- When b_{24} is at 0, blocks 7 and 8 are Write-protected
- When b_{25} is at 0, block 9 is Write-protected
- When b_{26} is at 0, block 10 is Write-protected
- When b_{27} is at 0, block 11 is Write-protected
- When b_{28} is at 0, block 12 is Write-protected
- When b_{29} is at 0, block 13 is Write-protected
- When b_{30} is at 0, block 14 is Write-protected
- When b_{31} is at 0, block 15 is Write-protected.

The OTP_Lock_Reg bits cannot be erased. Once Write-protected, EEPROM blocks behave like ROM blocks and cannot be unprotected.

Fixed Chip_ID (Option). The SRIX512 is provided with an anti-collision feature based on a random 8-bit Chip_ID. Prior to selecting an SRIX512, an anti-collision sequence has to be run to search for the Chip_ID of the SRIX512. This is a very flexible feature, however the searching loop requires time to run.

For some applications, much time could be saved by knowing the value of the SRIX512 Chip_ID beforehand, so that the SRIX512 can be identified and selected directly without having to run an anti-collision sequence. This is why the SRIX512 was designed with an optional mask setting used to program a fixed 8-bit Chip_ID to bits b_7 to b_0 of the system area. When the fixed Chip_ID option is used, the random Chip_ID function is disabled.

SRIX512 OPERATION

All commands, data and CRC are transmitted to the SRIX512 as 10-bit characters using ASK modulation. The start bit of the 10 bits, b_0 , is sent first. The command frame received by the SRIX512 at the antenna is demodulated by the 10% ASK demodulator, and decoded by the internal logic. Prior to any operation, the SRIX512 must have been selected by a SELECT command. Each frame transmitted to the SRIX512 must start with a Start Of Frame, followed by one or more data characters, two CRC Bytes and the final End Of Frame. When

an invalid frame is decoded by the SRIX512 (wrong command or CRC error), the memory does not return any error code.

When a valid frame is received, the SRIX512 may have to return data to the reader. In this case, data is returned using BPSK encoding, in the form of 10-bit characters framed by an SOF and an EOF. The transfer is ended by the SRIX512 sending the 2 CRC Bytes and the EOF.

SRIX512 STATES

The SRIX512 can be switched into different states. Depending on the current state of the SRIX512, its logic will only answer to specific commands. These states are mainly used during the anti-collision sequence, to identify and to access the SRIX512 in a very short time. The SRIX512 provides 6 different states, as described in the following paragraphs and in [Figure 21](#).

POWER-OFF State

The SRIX512 is in POWER-OFF state when the electromagnetic field around the tag is not strong enough. In this state, the SRIX512 does not respond to any command.

READY State

When the electromagnetic field is strong enough, the SRIX512 enters the READY state. After Power-up, the Chip_ID is initialized with a random value. The whole logic is reset and remains in this state until an INITIATE() command is issued. Any other command will be ignored by the SRIX512.

INVENTORY State

The SRIX512 switches from the READY to the INVENTORY state after an INITIATE() command has been issued. In INVENTORY state, the SRIX512 will respond to any anti-collision commands: INITIATE(), PCALL16() and

SLOT_MARKER(), and then remain in the INVENTORY state. It will switch to the SELECTED state after a SELECT(Chip_ID) command is issued, if the Chip_ID in the command matches its own. If not, it will remain in INVENTORY state.

SELECTED State

In SELECTED state, the SRIX512 is active and responds to all READ_BLOCK(), WRITE_BLOCK(), AUTHENTICATE() and GET_UID() commands. When an SRIX512 has entered the SELECTED state, it no longer responds to anti-collision commands. So that the reader can access another tag, the SRIX512 can be switched to the DESELECTED state by sending a SELECT(Chip_ID2) with a Chip_ID that does not match its own, or it can be placed in DEACTIVATED state by issuing a COMPLETION() command. Only one SRIX512 can be in SELECTED state at a time.

DESELECTED State

Once the SRIX512 is in DESELECTED state, only a SELECT(Chip_ID) command with a Chip_ID matching its own can switch it back to SELECTED state. All other commands are ignored.

DEACTIVATED State

When in this state, the SRIX512 can only be turned off. All commands are ignored.

Figure 21. State Transition Diagram

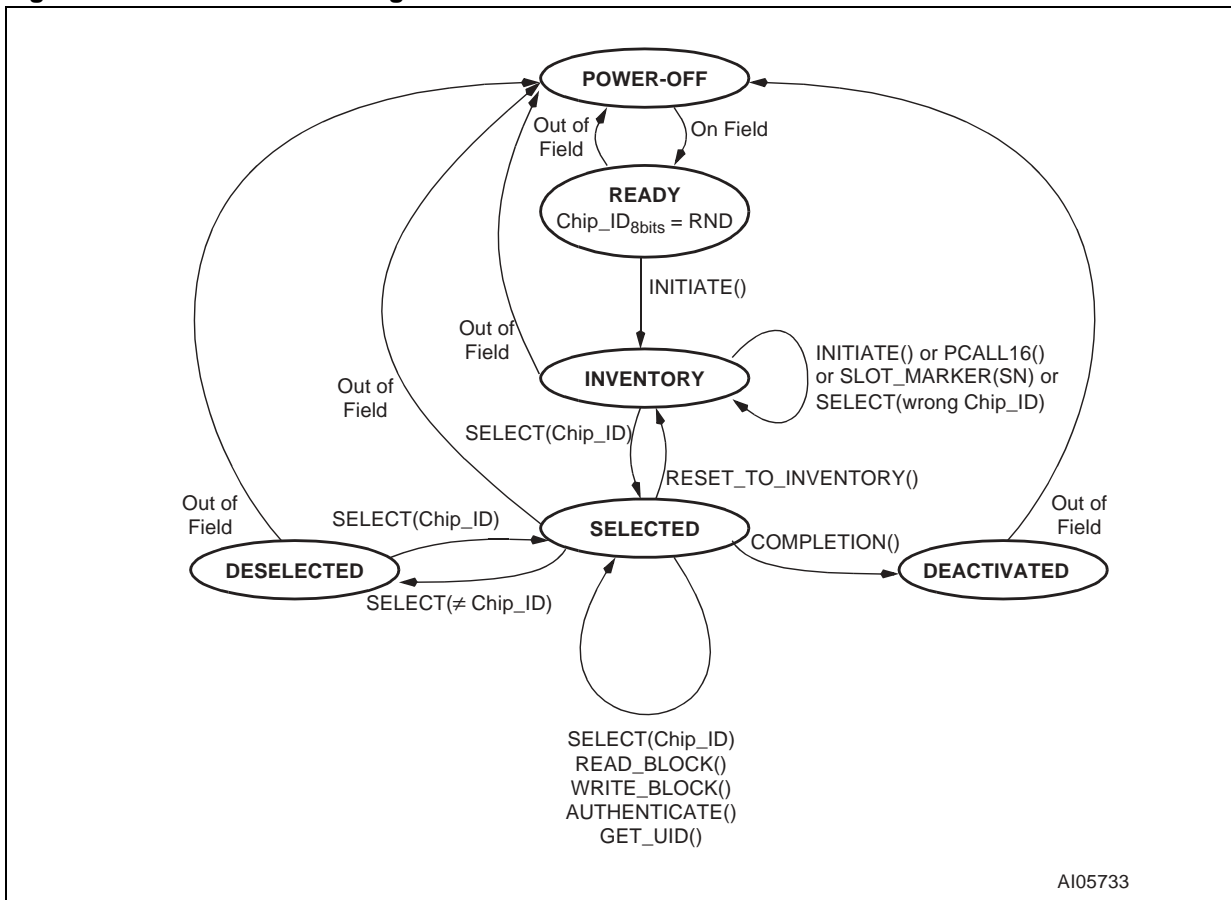

ANTI-COLLISION

The SRIX512 provides an anti-collision mechanism that searches for the Chip_ID of each device that is present in the reader field range. When known, the Chip_ID is used to select an SRIX512 individually, and access its memory. The anti-collision sequence is managed by the reader through a set of commands described in the “[SRIX512 OPERATION](#)” section:

- INITIATE()
- PCALL16()
- SLOT_MARKER().

The reader is the master of the communication with one or more SRIX512 device(s). It initiates the tag communication activity by issuing an INITIATE(), PCALL16() or SLOT_MARKER() command to prompt the SRIX512 to answer. During the anti-collision sequence, it might happen that two or more SRIX512 devices respond simultaneously, so causing a collision. The command set allows the reader to handle the sequence, to separate SRIX512 transmissions into different time slots. Once the anti-collision sequence has completed, SRIX512 communication is fully under the control of the reader, allowing only one SRIX512 to transmit at a time.

The Anti-collision scheme is based on the definition of time slots during which the SRIX512 devices

are invited to answer with minimum identification data: the Chip_ID. The number of slots is fixed at 16 for the PCALL16() command. For the INITIATE() command, there is no slot and the SRIX512 answers after the command is issued. SRIX512 devices are allowed to answer only once during the anticollision sequence. Consequently, even if there are several SRIX512 devices present in the reader field, there will probably be a slot in which only one SRIX512 answers, allowing the reader to capture its Chip_ID. Using the Chip_ID, the reader can then establish a communication channel with the identified SRIX512. The purpose of the anti-collision sequence is to allow the reader to select one SRIX512 at a time.

The SRIX512 is given an 8-bit Chip_ID value used by the reader to select only one among up to 256 tags present within its field range. The Chip_ID is initialized with a random value during the READY state, or after an INITIATE() command in the INVENTORY state.

The four least significant bits (b₀ to b₃) of the Chip_ID are also known as the CHIP_SLOT_NUMBER. This 4-bit value is used by the PCALL16() and SLOT_MARKER() commands during the anti-collision sequence in the INVENTORY state.

Figure 22. SRIX512 Chip_ID Description

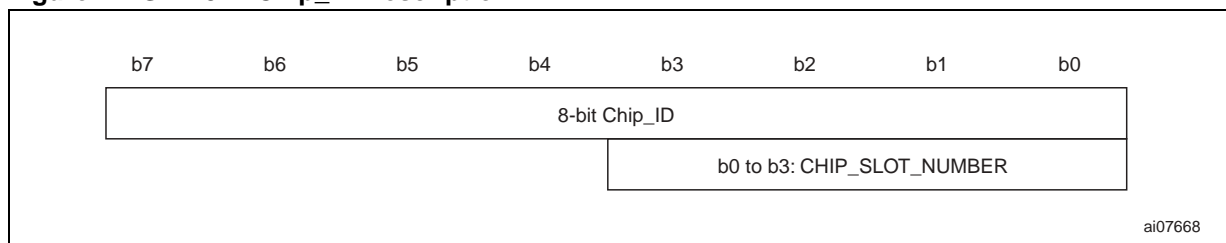

Each time the SRIX512 receives a PCALL16() command, the CHIP_SLOT_NUMBER is given a new 4-bit random value. If the new value is 0000_b, the SRIX512 returns its whole 8-bit Chip_ID in its answer to the PCALL16() command. The PCALL16() command is also used to define the slot number 0 of the anti-collision sequence. When the SRIX512 receives the SLOT_MARKER(SN)

command, it compares its CHIP_SLOT_NUMBER with the SLOT_NUMBER parameter (SN). If they match, the SRIX512 returns its Chip_ID as a response to the command. If they do not, the SRIX512 does not answer. The SLOT_MARKER(SN) command is used to define all the anti-collision slot numbers from 1 to 15.

Figure 23. Description of a Possible Anti-Collision Sequence

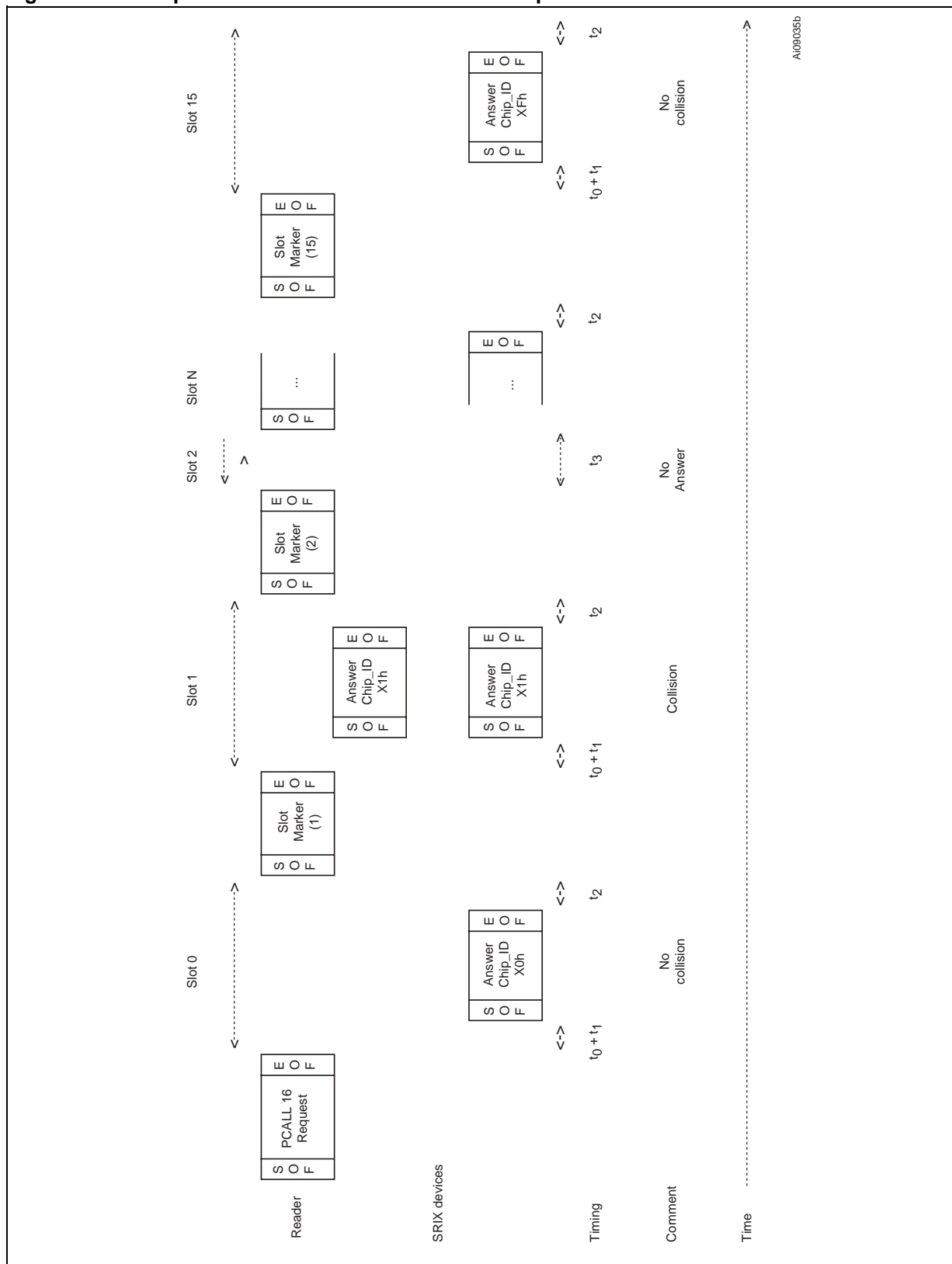

Note: The value X in the Answer Chip_ID means a random hexadecimal character from 0 to F.

Description of an Anti-Collision Sequence

The anti-collision sequence is initiated by the INITIATE() command which triggers all the SRIX512 devices that are present in the reader field range, and that are in INVENTORY state. Only SRIX512 devices in INVENTORY state will respond to the PCALL16() and SLOT_MARKER(SN) anti-collision commands.

A new SRIX512 introduced in the field range during the anti-collision sequence will not be taken

into account as it will not respond to the PCALL16() or SLOT_MARKER(SN) command (READY state). To be considered during the anti-collision sequence, it must have received the INITIATE() command and entered the INVENTORY state.

Table 3. shows the elements of a standard anti-collision sequence. (See Figure 24. for an example.)

Table 3. Standard Anti-Collision Sequence

Step 1	Init:	Send INITIATE(). – If no answer is detected, go to step1. – If only 1 answer is detected, select and access the SRIX512. After accessing the SRIX512, deselect the tag and go to step1. – If a collision (many answers) is detected, go to step2.
Step 2	Slot 0	Send PCALL16(). – If no answer or collision is detected, go to step3. – If 1 answer is detected, store the Chip_ID, Send SELECT() and go to step3.
Step 3	Slot 1	Send SLOT_MARKER(1). – If no answer or collision is detected, go to step4. – If 1 answer is detected, store the Chip_ID, Send SELECT() and go to step4.
Step 4	Slot 2	Send SLOT_MARKER(2). – If no answer or collision is detected, go to step5. – If 1 answer is detected, store the Chip_ID, Send SELECT() and go to step5.
Step N	Slop N	Send SLOT_MARKER(3 up to 14) ... – If no answer or collision is detected, go to stepN+1. – If 1 answer is detected, store the Chip_ID, Send SELECT() and go to stepN+1.
Step 17	Slot 15	Send SLOT_MARKER(15). – If no answer or collision is detected, go to step18. – If 1 answer is detected, store the Chip_ID, Send SELECT() and go to step18.
Step 18		All the slots have been generated and the Chip_ID values should be stored into the reader memory. Issue the SELECT(Chip_ID) command and access each identified SRIX512 one by one. After accessing each SRIX512, switch them into DESELECTED or DEACTIVATED state, depending on the application needs. – If collisions were detected between Step2 and Step17, go to Step2. – If no collision was detected between Step2 and Step17, go to Step1.

After each SLOT_MARKER() command, there may be several, one or no answers from the SRIX512 devices. The reader must handle all the cases and store all the Chip_IDs, correctly decoded. At the end of the anti-collision sequence, after SLOT_MARKER(15), the reader can start working with one SRIX512 by issuing a SELECT() com-

mand containing the desired Chip_ID. If a collision is detected during the anti-collision sequence, the reader has to generate a new sequence in order to identify all unidentified SRIX512 devices in the field. The anti-collision sequence can stop when all SRIX512 devices have been identified.

Figure 24. Example of an Anti-Collision Sequence

Command	Tag 1 Chip_ID	Tag 2 Chip_ID	Tag 3 Chip_ID	Tag 4 Chip_ID	Tag 5 Chip_ID	Tag 6 Chip_ID	Tag 7 Chip_ID	Tag 8 Chip_ID	Comments
READY State	28h	75h	40h	01h	02h	FEh	A9h	7Ch	Each tag gets a random Chip_ID
INITIATE ()	40h	13h	3Fh	4Ah	50h	48h	52h	7Ch	Each tag get a new random Chip_ID. All tags answer: collisions
PCALL16()	45h	12h	30h	43h	55h	43h	53h	73h	All CHIP_SLOT_NUMBERS get a new random value
SELECT(30h)			30h						Slot0: only one answer Tag3 is identified
SLOT_MARKER(1)									Slot1: no answer
SLOT_MARKER(2)		12h							Slot2: only one answer
SELECT(12h)		12h							Tag2 is identified
SLOT_MARKER(3)				43h		43h	53h	73h	Slot3: collisions
SLOT_MARKER(4)									Slot4: no answer
SLOT_MARKER(5)	45h				55h				Slot5: collisions
SLOT_MARKER(6)									Slot6: no answer
SLOT_MARKER(N)									SlotN: no answer
SLOT_MARKER(F)									SlotF: no answer
PCALL16()	40h			41h	53h	42h	50h	74h	All CHIP_SLOT_NUMBERS get a new random value
SLOT_MARKER(1)	40h			41h			50h		Slot0: collisions
SELECT(41h)				41h					Slot1: only one answer Tag4 is identified
SLOT_MARKER(2)						42h			Slot2: only one answer
SELECT(42h)						42h			Tag6 is identified
SLOT_MARKER(3)					53h				Slot3: only one answer
SELECT(53h)					53h				Tag5 is identified
SLOT_MARKER(4)								74h	Slot4: only one answer
SELECT(74h)								74h	Tag8 is identified
SLOT_MARKER(N)									SlotN: no answer
PCALL16()	41h						50h		All CHIP_SLOT_NUMBERS get a new random value
SELECT(50h)							50h		Slot0: only one answer Tag7 is identified
SLOT_MARKER(1)	41h								Slot1: only one answer but already found for tag4
SLOT_MARKER(N)									SlotN: no answer
PCALL16()	43h								All CHIP_SLOT_NUMBERS get a new random value
SLOT_MARKER(3)	43h								Slot0: only one answer Slot3: only one answer
SELECT(43h)	43h								Tag1 is identified
									All tags are identified

ai07669



ANTI-CLONE FUNCTION

The SRIX512 provides an anti-clone function that allows the application to authentication the device. This function uses reserved data that is stored in the SRIX512 memory at its time of manufacture.

The Authentication system is based on a proprietary challenge/response mechanism which allows the application software to authenticate any member of the secure memory tag SRXxxx family from STMicroelectronics (of which the SRIX512 is

the prime example). A reader system, based on the ST CRX14 chip coupler, can check each SRIX512 tag for authenticity, and protect the application system against silicon copies or emulators.

A complete description of the Authentication system is available under Non Disclosure Agreement (NDA) with STMicroelectronics. For more details about this SRIX512 function, please contact your nearest STMicroelectronics sales office.

SRIX512 COMMANDS

See the paragraphs below for a detailed description of the Commands available on the SRIX512. The commands and their hexadecimal codes are summarized in [Table 4](#).. A brief is given in [APPENDIX B](#)..

Table 4. Command Code

Hexadecimal Code	Command
06h-00h	INITIATE()
06h-04h	PCALL16()
x6h	SLOT_MARKER (SN)
08h	READ_BLOCK(Addr)
09h	WRITE_BLOCK(Addr, Data)
0Ah	AUTHENTICATE(RND)
0Bh	GET_UID()
0Ch	RESET_TO_INVENTORY
0Eh	SELECT(Chip_ID)
0Fh	COMPLETION()

INITIATE() Command

Command Code = 06h - 00h

INITIATE() is used to initiate the anti-collision sequence of the SRIX512. On receiving the INITIATE() command, all SRIX512 devices in READY state switch to INVENTORY state, set a

new 8-bit Chip_ID random value, and return their Chip_ID value. This command is useful when only one SRIX512 in READY state is present in the reader field range. It speeds up the Chip_ID search process. The CHIP_SLOT_NUMBER is not used during INITIATE() command access.

Figure 25. INITIATE Request Format

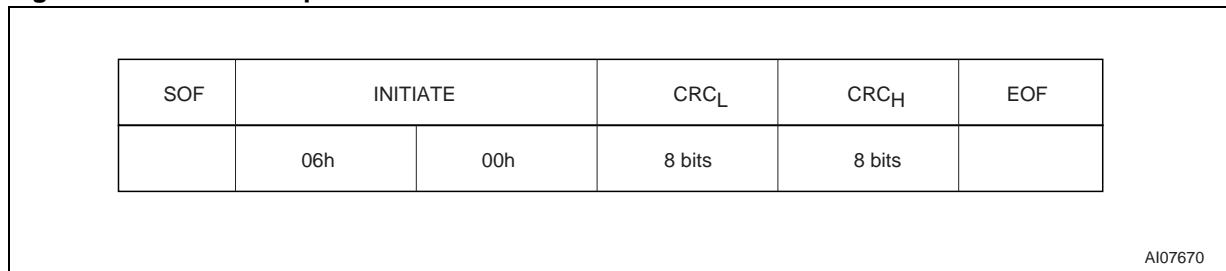

Request parameter:

- No parameter

Figure 26. INITIATE Response Format

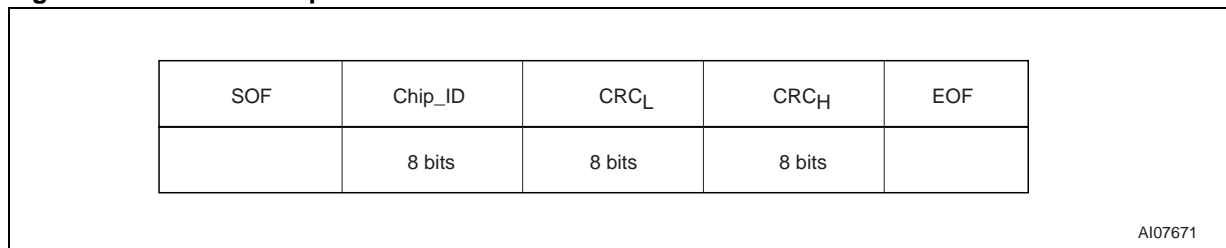

Response parameter:

- Chip_ID of the SRIX512

Figure 27. INITIATE Frame Exchange Between Reader and SRIX512

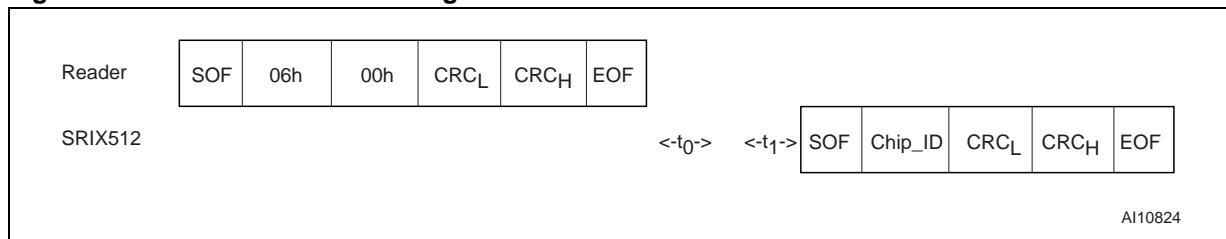

SRIX512

PCALL16() Command

Command Code = 06h - 04h

The SRIX512 must be in INVENTORY state to interpret the PCALL16() command.

On receiving the PCALL16() command, the SRIX512 first generates a new random CHIP_SLOT_NUMBER value (in the 4 least significant bits of the Chip_ID). CHIP_SLOT_NUMBER can take on a value between 0 and 15 (1111_b). The value is retained until a new PCALL16() or INITIATE() command is issued, or until the SRIX512

is powered off. The new CHIP_SLOT_NUMBER value is then compared with the value 0000_b. If they match, the SRIX512 returns its Chip_ID value. If not, the SRIX512 does not send any response.

The PCALL16() command, used together with the SLOT_MARKER() command, allows the reader to search for all the Chip_IDs when there are more than one SRIX512 device in INVENTORY state present in the reader field range.

Figure 28. PCALL16 Request Format

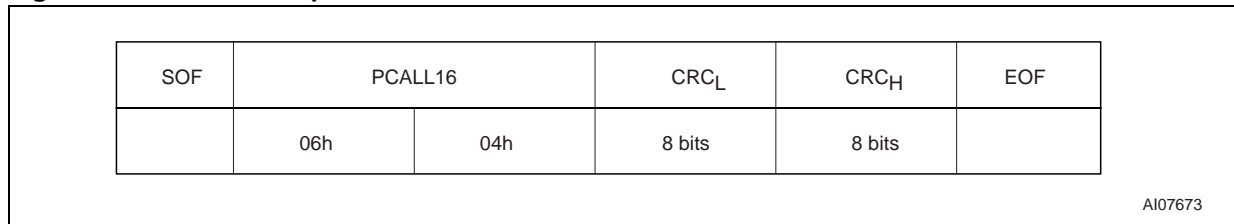

Request parameter:

- No parameter

Figure 29. PCALL16 Response Format

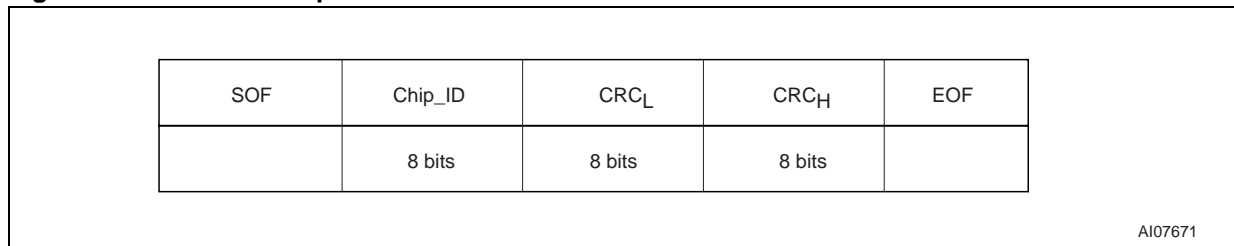

Response parameter:

- Chip_ID of the SRIX512

Figure 30. PCALL16 Frame Exchange Between Reader and SRIX512

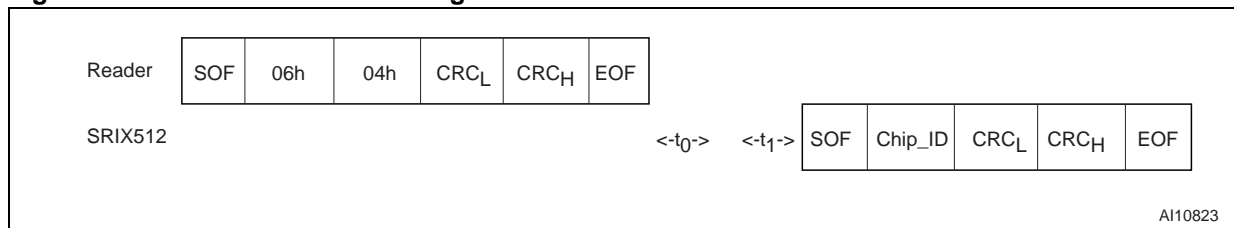

SLOT_MARKER(SN) Command

Command Code = x6h

The SRIX512 must be in INVENTORY state to interpret the SLOT_MARKER(SN) command.

The SLOT_MARKER Byte code is divided into two parts:

- b₃ to b₀: 4-bit command code with fixed value 6.
- b₇ to b₄: 4 bits known as the SLOT_NUMBER (SN). They assume a value between 1 and 15. The value 0 is reserved by the PCALL16() command.

On receiving the SLOT_MARKER() command, the SRIX512 compares its CHIP_SLOT_NUMBER value with the SLOT_NUMBER value given in the command code. If they match, the SRIX512 returns its Chip_ID value. If not, the SRIX512 does not send any response.

The SLOT_MARKER() command, used together with the PCALL16() command, allows the reader to search for all the Chip_IDs when there are more than one SRIX512 device in INVENTORY state present in the reader field range.

Figure 31. SLOT_MARKER Request Format

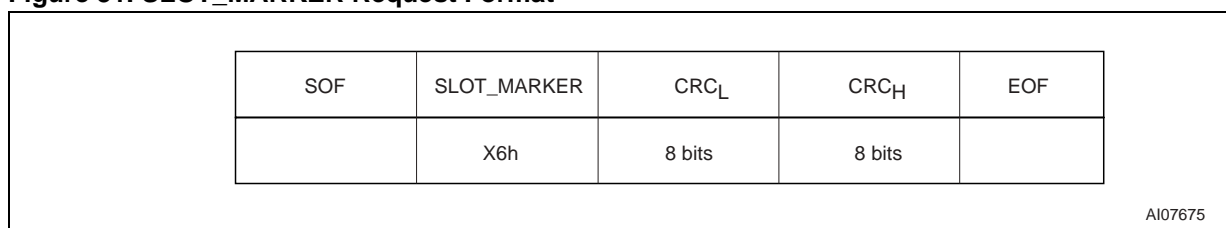

Request parameter:

- x: Slot number

Figure 32. SLOT_MARKER Response Format

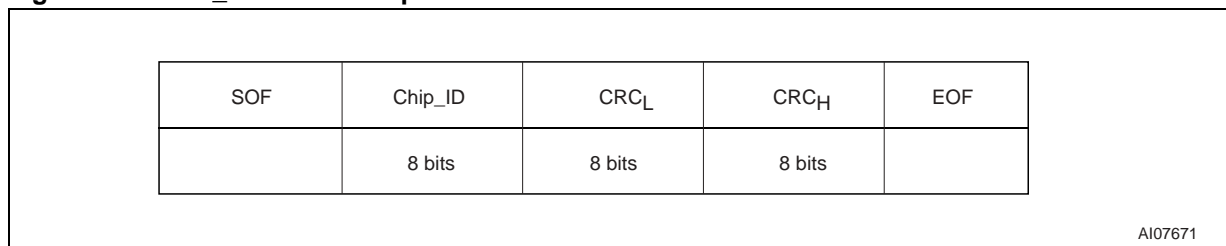

Response parameters:

- Chip_ID of the SRIX512

Figure 33. SLOT_MARKER Frame Exchange Between Reader and SRIX512

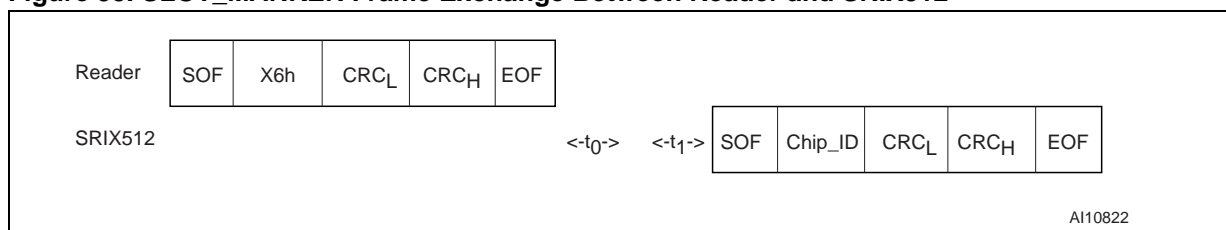

SRIX512

SELECT(Chip_ID) Command

Command Code = 0Eh

The SELECT() command allows the SRIX512 to enter the SELECTED state. Until this command is issued, the SRIX512 will not accept any other command, except for INITIATE(), PCALL16() and

SLOT_MARKER(). The SELECT() command returns the 8 bits of the Chip_ID value. An SRIX512 in SELECTED state, that receives a SELECT() command with a Chip_ID that does not match its own is automatically switched to DESELECTED state.

Figure 34. SELECT Request Format

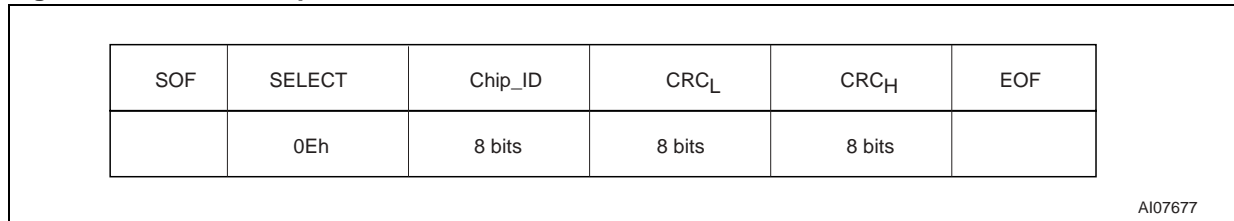

Request parameter:

- 8-bit Chip_ID stored during the anti-collision sequence

Figure 35. SELECT Response Format

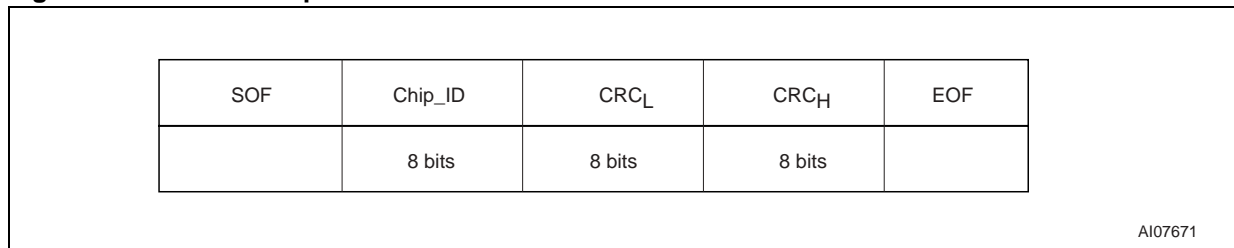

Response parameters:

- Chip_ID of the selected tag. Must be equal to the transmitted Chip_ID

Figure 36. SELECT Frame Exchange Between Reader and SRIX512

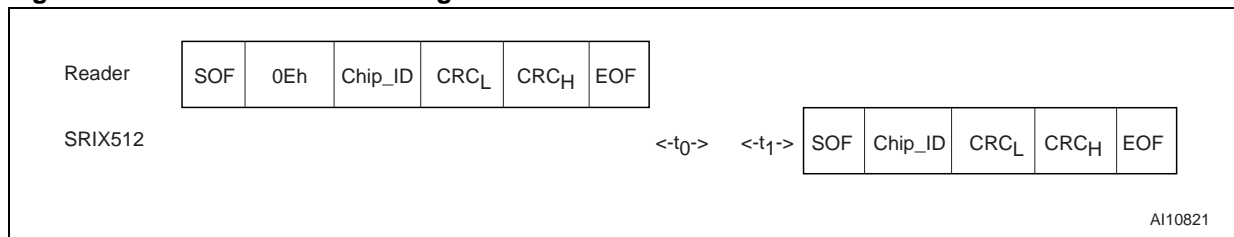

COMPLETION() Command

Command Code = 0Fh

On receiving the COMPLETION() command, a SRIX512 in SELECTED state switches to DEACTIVATED state and stops decoding any new commands. The SRIX512 is then locked in this state until a complete reset (tag out of the field range).

A new SRIX512 can thus be accessed through a SELECT() command without having to remove the previous one from the field. The COMPLETION() command does not generate a response.

All SRIX512 devices not in SELECTED state ignore the COMPLETION() command.

Figure 37. COMPLETION Request Format

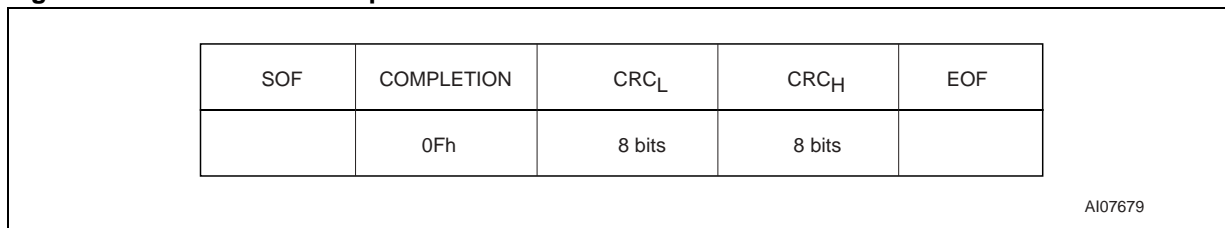

Request parameters:

- No parameter

Figure 38. COMPLETION Response Format

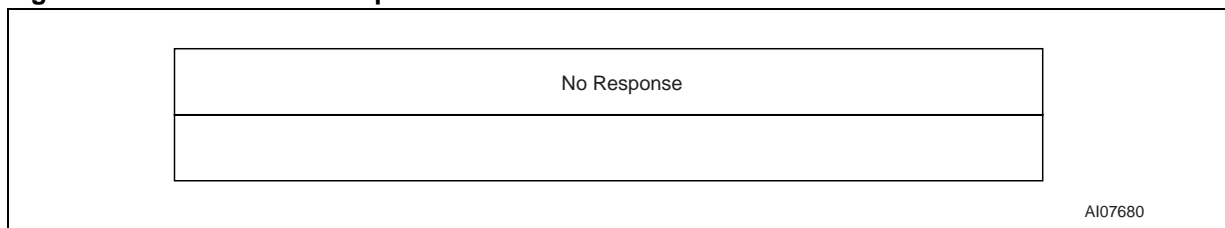
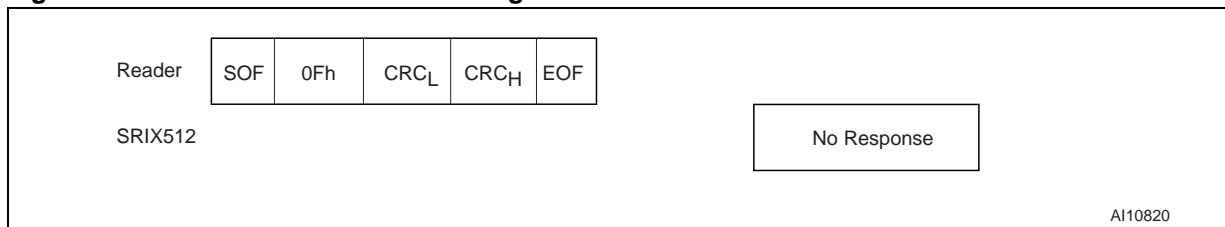

Figure 39. COMPLETION Frame Exchange Between Reader and SRIX512



SRIX512

RESET_TO_INVENTORY() Command

Command Code = 0Ch

On receiving the RESET_TO_INVENTORY() command, all SRIX512 devices in SELECTED state revert to INVENTORY state. The concerned SRIX512 devices are thus resubmitted to the anti-collision sequence. This command is useful when two SRIX512 devices with the same 8-bit Chip_ID happen to be in SELECTED state at the same

time. Forcing them to go through the anti-collision sequence again allows the reader to generate new PCALL16() commands and so, to set new random Chip_IDs.

The RESET_TO_INVENTORY() command does not generate a response.

All SRIX512 devices that are not in SELECTED state ignore the RESET_TO_INVENTORY() command.

Figure 40. RESET_TO_INVENTORY Request Format

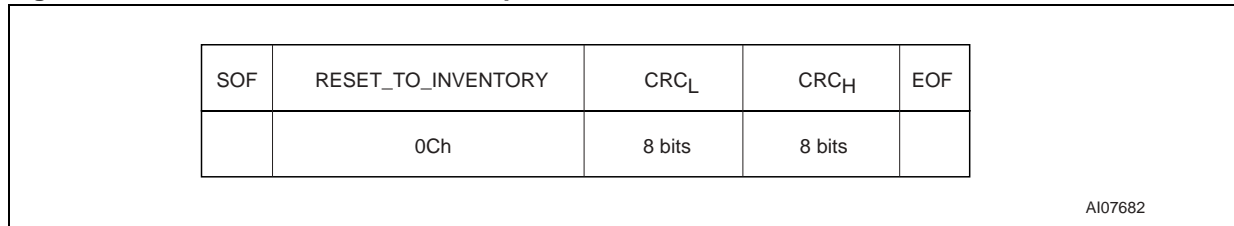

Request parameter:

- No parameter

Figure 41. RESET_TO_INVENTORY Response Format

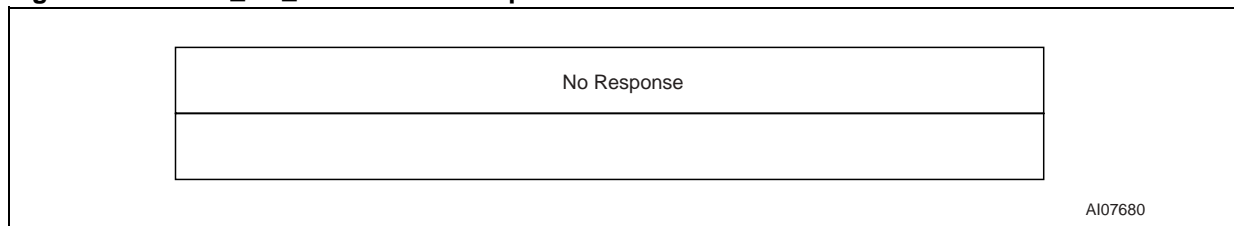
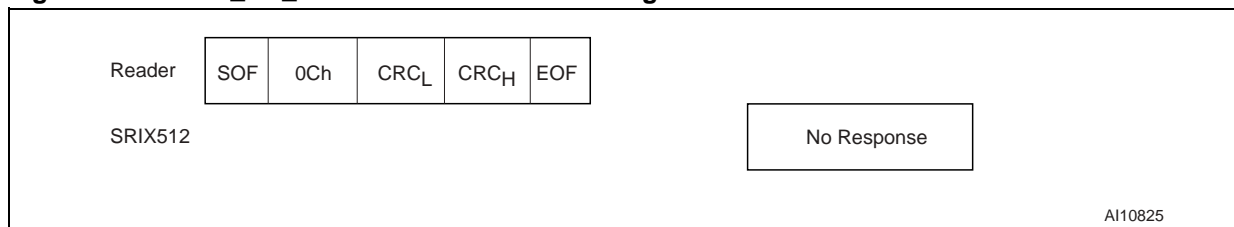

Figure 42. RESET_TO_INVENTORY Frame Exchange Between Reader and SRIX512



WRITE_BLOCK (Addr, Data) Command

Command Code = 09h

On receiving the WRITE_BLOCK command, the SRIX512 writes the 4 bytes contained in the command to the addressed block, provided that the block is available and not Write-protected. Data Bytes are transmitted with the Least Significant Byte first, and each byte is transmitted with the least significant bit first.

The address Byte gives access to the 16 blocks of the SRIX512 (addresses 0 to 15). WRITE_BLOCK commands issued with a block address above 15 will not be interpreted and the SRIX512 will not return any response, except for the System area located at address 255.

The result of the WRITE_BLOCK command is submitted to the addressed block. See the follow-

ing paragraphs for a complete description of the WRITE_BLOCK command:

- [Resettable OTP Area \(addresses 0 to 4\).](#)
- [Binary Counter \(addresses 5 to 6\).](#)
- [EEPROM \(Addresses 7 to 15\).](#)

The WRITE_BLOCK command does not give rise to a response from the SRIX512. The reader must check after the programming time, t_W , that the data was correctly programmed. The SRIX512 must have received a SELECT() command and be switched to SELECTED state before any WRITE_BLOCK command can be accepted. All WRITE_BLOCK commands sent to the SRIX512 before a SELECT() command is issued, are ignored.

Figure 46. WRITE_BLOCK Request Format

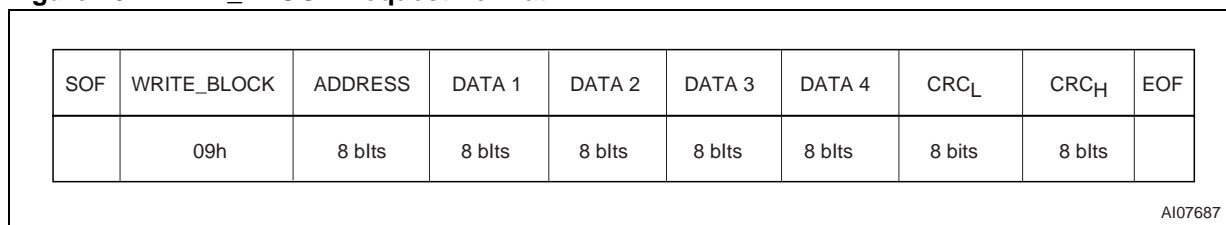

Request parameters:

- ADDRESS: block addresses from 0 to 15, or 255
- DATA 1: Less significant data Byte
- DATA 2: Data Byte
- DATA 3: Data Byte
- DATA 4: Most significant data Byte.

Figure 47. WRITE_BLOCK Response Format

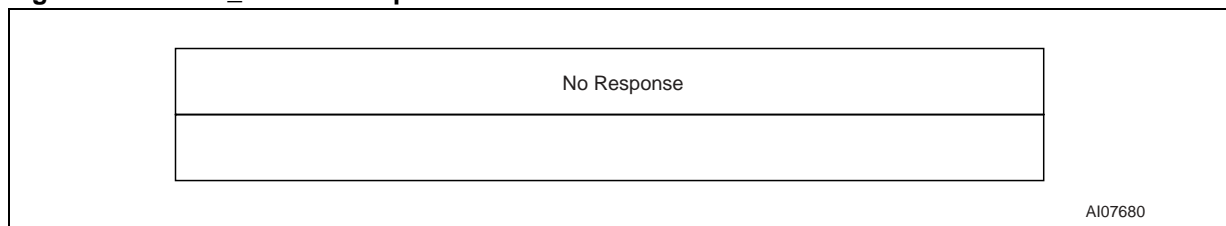
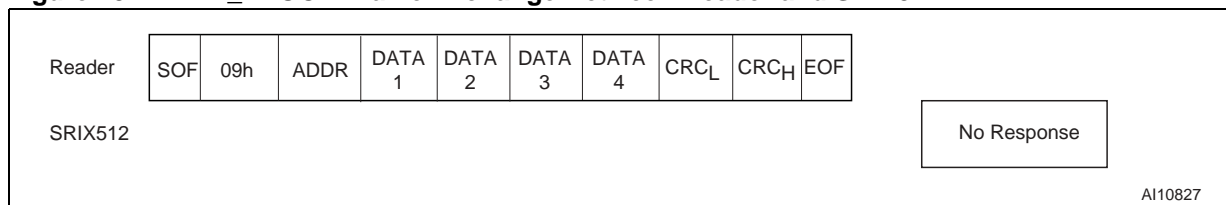

Figure 48. WRITE_BLOCK Frame Exchange Between Reader and SRIX512



GET_UID() Command

Command Code = 0Bh

On receiving the GET_UID command, the SRIX512 returns its 8 UID Bytes. UID Bytes are transmitted with the Least Significant Byte first, and each byte is transmitted with the least significant bit first.

The SRIX512 must have received a SELECT() command and be switched to SELECTED state before any GET_UID() command can be accepted. All GET_UID() commands sent to the SRIX512 before a SELECT() command is issued, are ignored.

Figure 49. GET_UID Request Format

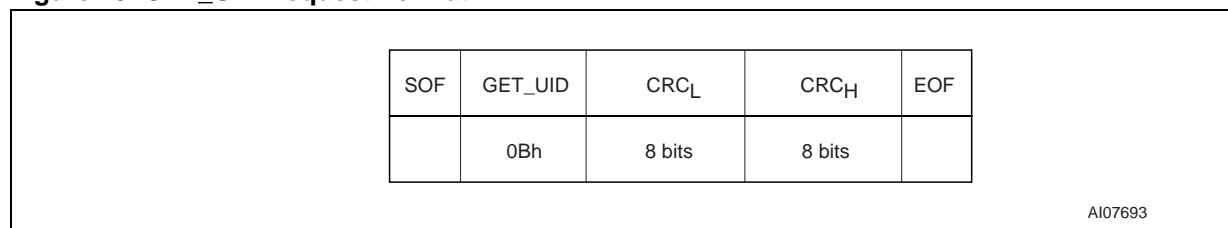

Request parameter:

- No parameter

Figure 50. GET_UID Response Format

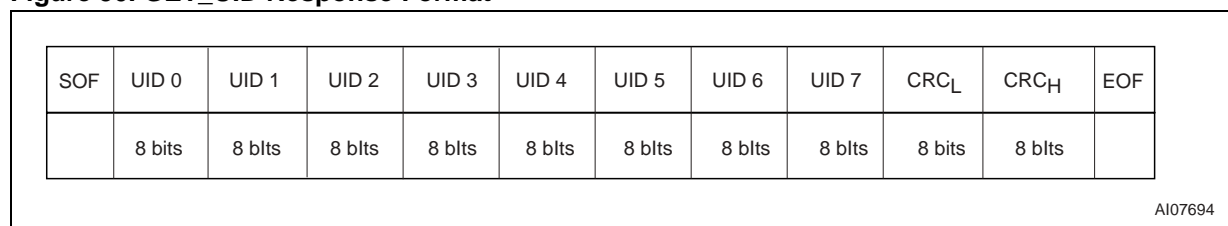

Response parameters:

- UID 0: Less significant UID Byte
- UID 1 to UID 6: UID Bytes
- UID 7: Most significant UID Byte.

Figure 51. GET_UID Frame Exchange Between Reader and SRIX512

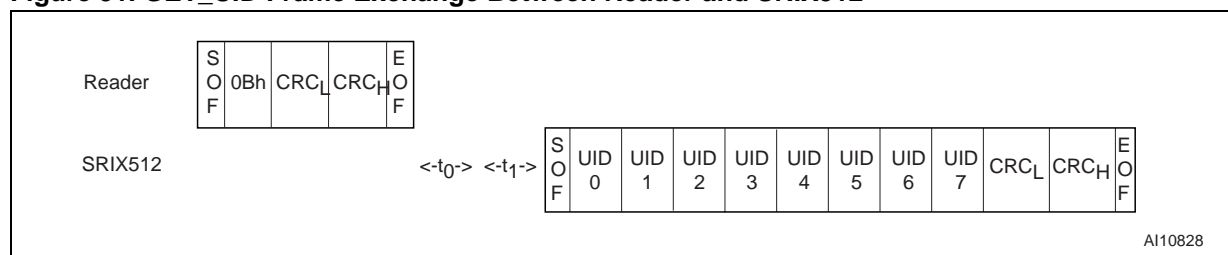

Power-On State

After Power-On, the SRIX512 is in the following state:

- It is in the low-power state.
- It is in READY state.
- It shows highest impedance with respect to the reader antenna field.
- It will not respond to any command except INITIATE().

MAXIMUM RATING

Stressing the device above the rating listed in the Absolute Maximum Ratings table may cause permanent damage to the device. These are stress ratings only and operation of the device at these or any other conditions above those indicated in the Operating sections of this specification is not im-

plied. Exposure to Absolute Maximum Rating conditions for extended periods may affect device reliability. Refer also to the STMicroelectronics SURE Program and other relevant quality documents.

Table 5. Absolute Maximum Ratings

Symbol	Parameter		Min.	Max.	Unit
T _{STG} , h _{STG} , t _{STG}	Storage Conditions	Wafer	15	25	°C
				23	months
			kept in its antistatic bag		
		A3, A4, A5	15	25	°C
			40%	60%	RH
				2	years
I _{CC}	Supply Current on AC0 / AC1		-20	20	mA
V _{MAX}	Input Voltage on AC0 / AC1		-7	7	V
V _{ESD}	Electrostatic Discharge Voltage	Machine model ¹	-100	100	V
		Human Body model ¹	-1000	1000	V
		Human Body model ²	-4000	4000	V

Note: 1. Mil. Std. 883 - Method 3015
 2. ESD test: ISO10373-6 for proximity cards

DC AND AC PARAMETERS

Table 6. Operating Conditions

Symbol	Parameter	Min.	Max.	Unit
T _A	Ambient Operating Temperature	-20	85	°C

Table 7. DC Characteristics

Symbol	Parameter	Condition	Min	Max	Unit
V _{CC}	Regulated Voltage		2.5	3.5	V
I _{CC}	Supply Current (Active in Read)	V _{CC} = 3.0V		100	μA
I _{CC}	Supply Current (Active in Write)	V _{CC} = 3.0V		250	μA
V _{RET}	Retromodulation Induced Voltage	ISO10373-6	20		mV
C _{TUN}	Internal Tuning Capacitor	70pF at 13.56MHz	64	78	pF

Table 8. AC Characteristics

Symbol	Parameter	Condition	Min	Max	Unit
f _{CC}	External RF Signal Frequency		13.553	13.567	MHz
MI _{CARRIER}	Carrier Modulation Index	MI=(A-B)/(A+B)	8	14	%
t _{RFR} , t _{RFF}	10% Rise and Fall times		0.8	2.5	μs
t _{RFSBL}	Minimum Pulse Width for Start bit	ETU = 128/f _{CC}	9.44		μs
t _{JIT}	ASK modulation Data Jitter	Coupler to SRIX512	-2	+2	μs
t _{MIN CD}	Minimum Time from Carrier Generation to First Data		5		ms
f _S	Subcarrier Frequency	f _{CC} /16	847.5		kHz
t ₀	Antenna Reversal Delay	128/f _S	151		μs
t ₁	Synchronization Delay	128/f _S	151		μs
t ₂	Answer to New Request Delay	14 ETU	132		μs
t _{DR}	Time Between Request Characters	Coupler to SRIX512	0	57	μs
t _{DA}	Time Between Answer Characters	SRIX512 to Coupler	0		μs
t _W	Programming Time for WRITE	With no Auto-Erase Cycle (OTP)		3	ms
		With Auto-Erase Cycle (EEPROM)		5	ms
		Binary Counter Decrement		7	ms

Note: 1. All timing measurements were performed on a reference antenna with the following characteristics:

External size: 75mm x 48mm
 Number of turns: 3
 Width of conductor: 1mm
 Space between 2 conductors: 0.4mm
 Value of the coil: 1.4μH
 Tuning Frequency: 14.4MHz.

Figure 52. SRIX512 Synchronous Timing, Transmit and Receive

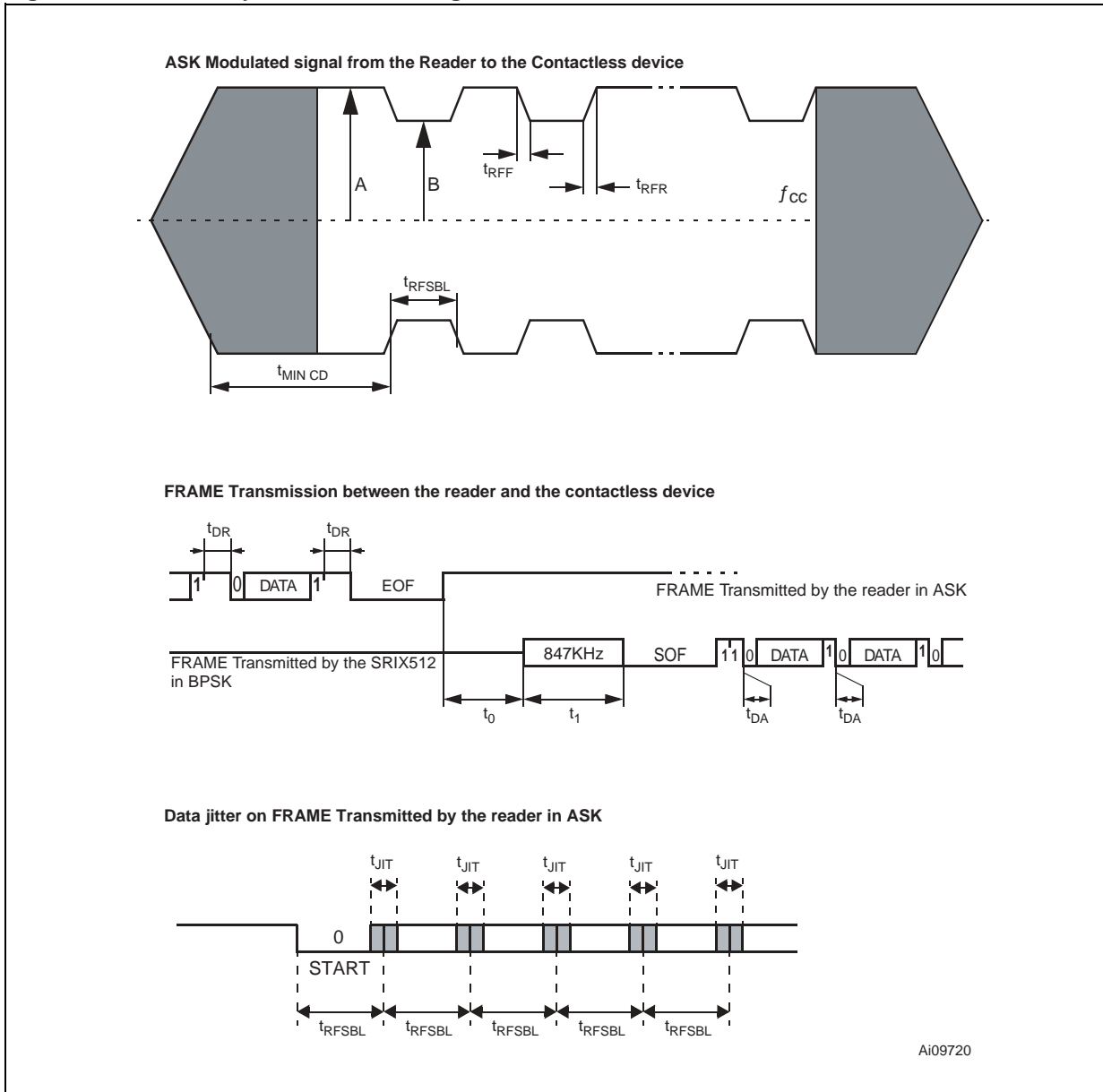

PACKAGE MECHANICAL

Figure 53. A3 Antenna Specification

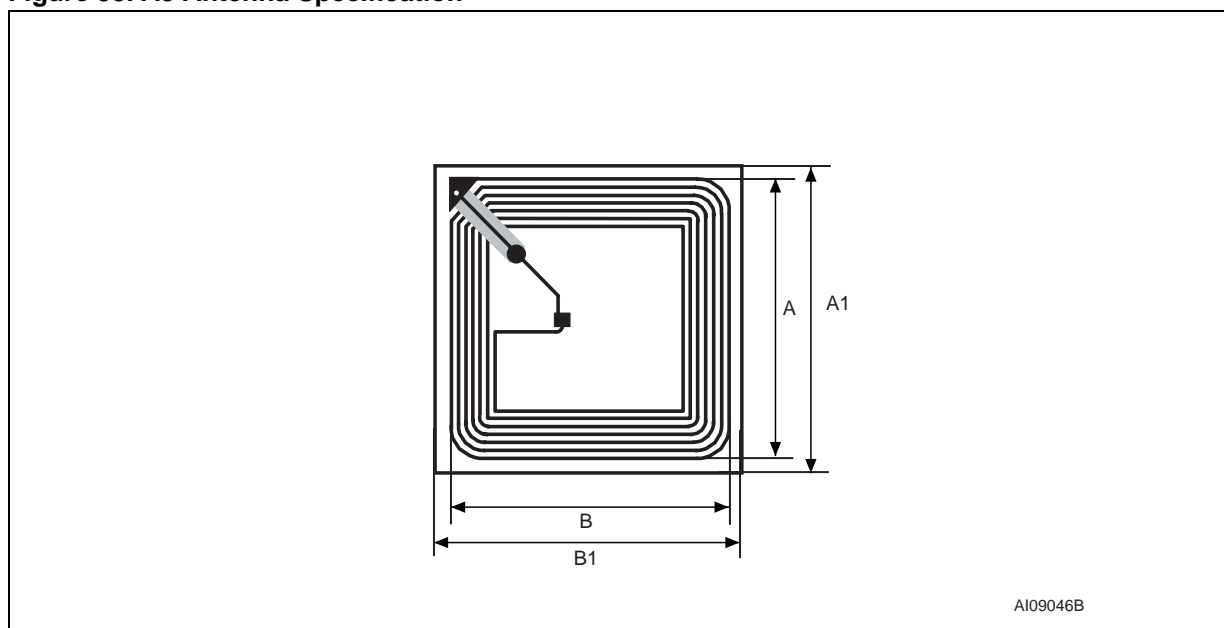

Table 9. A3 Antenna Specification

Symbol	Parameter	Type	Min	Max	Unit
A	Coil Width	38	37.5	38.5	mm
B	Coil Length	38	37.5	38.5	mm
A1	Inlay Width	43	42.5	43.5	mm
B1	Inlay Length	43	42.5	43.5	mm
	Overall Thickness of Copper Antenna Coil	110	90	130	μm
	Silicon Thickness	180	165	195	μm
Q	Unloaded Q Value	40			
F _{NOM}	Unloaded Free-air Resonance	15.1			MHz
P _A	H-field Energy for Device Operation		0.5 114		A/m db $\mu\text{A/m}$

Figure 54. A4 Antenna Specification

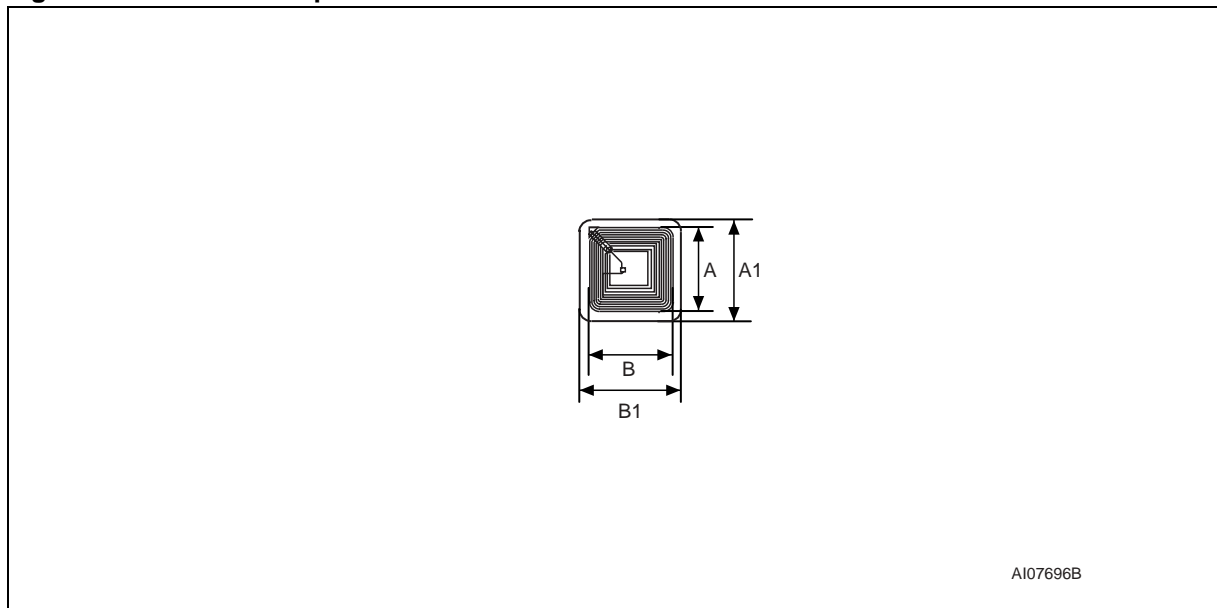

Table 10. A4 Antenna Specification

Symbol	Parameter	Type	Min	Max	Unit
A	Coil Width	15	14.5	15.5	mm
B	Coil Length	15	14.5	15.5	mm
A1	Inlay Width	19	18.5	19.5	mm
B1	Inlay Length	19	18.5	19.5	mm
	Overall Thickness of Copper Antenna Coil	110	90	130	μm
	Silicon Thickness	180	165	195	μm
Q	Unloaded Q Value	30			
F_{NOM}	Unloaded Free-air Resonance	14.5			MHz
P_A	H-field Energy for Device Operation		1.5 123.5		A/m $\text{db}\mu\text{A/m}$

Figure 55. A5 Antenna Specification

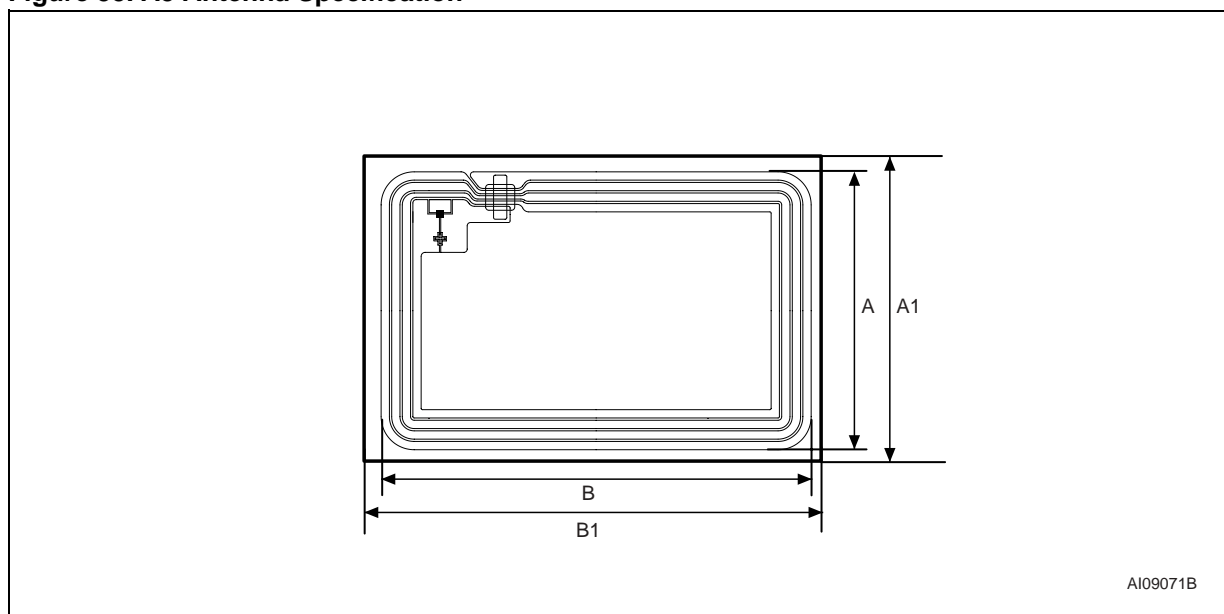

Table 11. A5 Antenna Specification

Symbol	Parameter	Type	Min	Max	Unit
A	Coil Width	42	41.5	42.5	mm
B	Coil Length	65	64.5	65.5	mm
A1	Inlay Width	46	45.5	46.5	mm
B1	Inlay Length	70	69.5	70.5	mm
	Overall Thickness of Copper Antenna Coil	140	130	150	μm
	Silicon Thickness	180	165	195	μm
Q	Unloaded Q Value	30			
F _{NOM}	Unloaded Free-air Resonance	14.8			MHz
P _A	H-field Energy for Device Operation		0.25 108		A/m dB μ A/m

APPENDIX A. ISO14443 TYPE B CRC CALCULATION

```

#include <stdio.h>
#include <stdlib.h>
#include <string.h>
#include <ctype.h>
#define BYTE unsigned char
#define USHORT unsigned short

unsigned short UpdateCrc(BYTE ch, USHORT
*lpwCrc)
{
    ch = (ch^(BYTE)((*lpwCrc) & 0x00FF));
    ch = (ch^(ch<<4));
    *lpwCrc = (*lpwCrc >> 8)^((USHORT)ch <<
8)^((USHORT)ch<<3)^((USHORT)ch>>4);
    return(*lpwCrc);
}

void ComputeCrc(char *Data, int Length,
BYTE *TransmitFirst, BYTE *TransmitSecond)
{
    BYTE chBlock; USHORTt wCrc;
    wCrc = 0xFFFF; // ISO 3309
    do
        {
            chBlock = *Data++;
            UpdateCrc(chBlock, &wCrc);
        } while (--Length);
    wCrc = ~wCrc; // ISO 3309
    *TransmitFirst = (BYTE) (wCrc & 0xFF);
    *TransmitSecond = (BYTE) ((wCrc >> 8) &
0xFF);
    return;
}

int main(void)
{
    BYTE BuffCRC_B[10] = {0x0A, 0x12, 0x34,
0x56}, First, Second, i;
    printf("Crc-16 G(x) = x^16 + x^12 + x^5
+ 1");
    printf("CRC_B of [ ");
    for(i=0; i<4; i++)
        printf("%02X ",BuffCRC_B[i]);
    ComputeCrc(BuffCRC_B, 4, &First,
&Second);
    printf("] Transmitted: %02X then
%02X.", First, Second);
    return(0);
}

```

APPENDIX B. SRIX512 COMMAND BRIEF

Figure 56. INITIATE Frame Exchange Between Reader and SRIX512

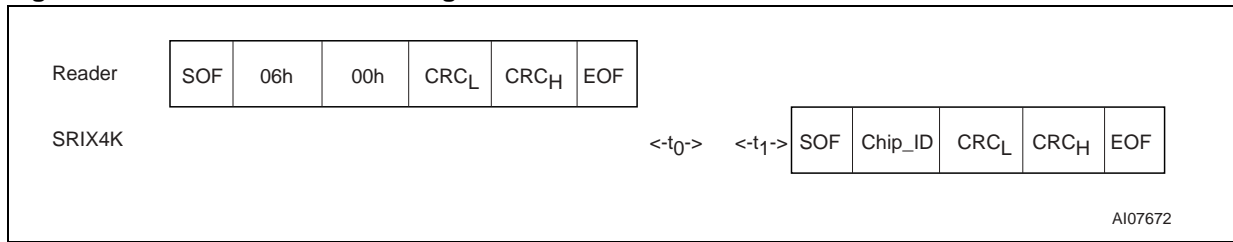

Figure 57. PCALL16 Frame Exchange Between Reader and SRIX512

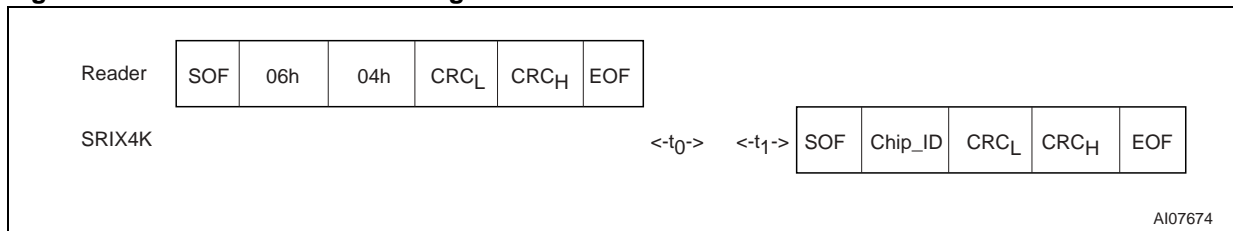

Figure 58. SLOT_MARKER Frame Exchange Between Reader and SRIX512

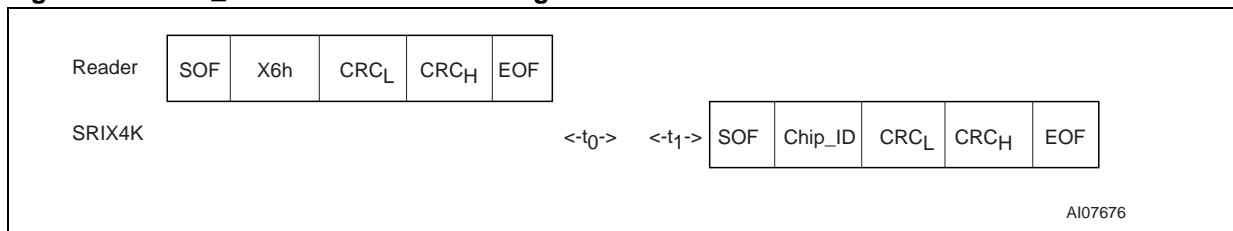

Figure 59. SELECT Frame Exchange Between Reader and SRIX512

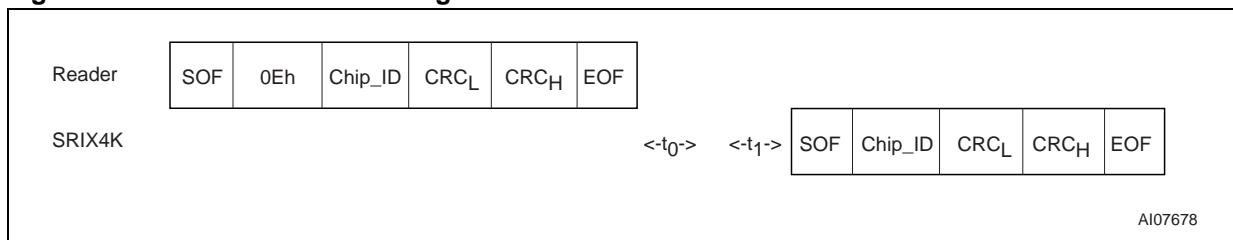

Figure 60. COMPLETION Frame Exchange Between Reader and SRIX512

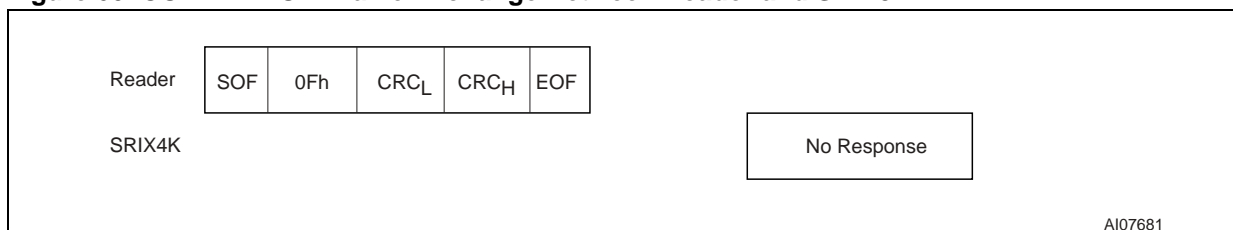

Figure 61. RESET_TO_INVENTORY Frame Exchange Between Reader and SRIX512

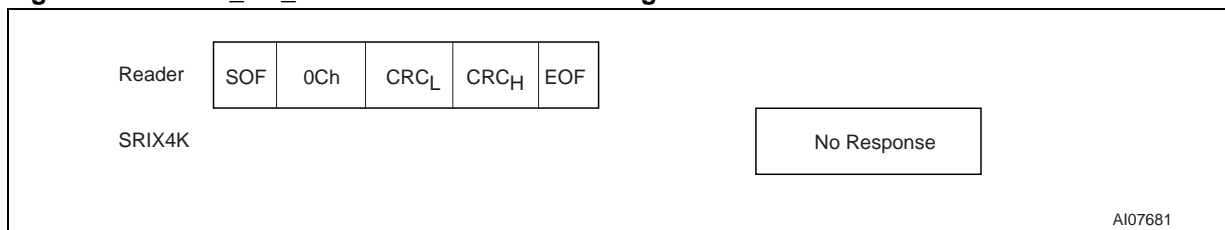

Figure 62. READ_BLOCK Frame Exchange Between Reader and SRIX512

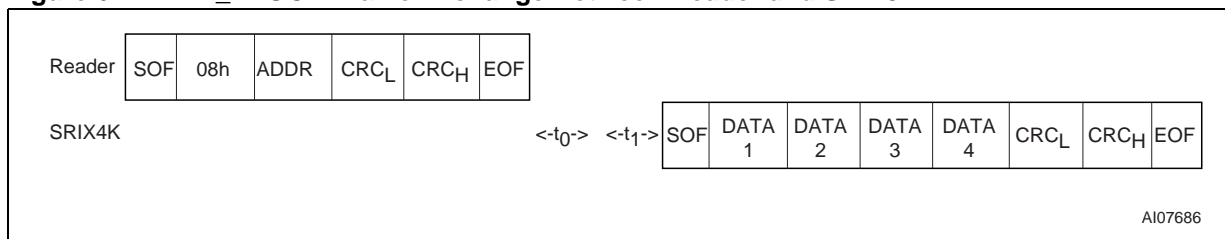

Figure 63. WRITE_BLOCK Frame Exchange Between Reader and SRIX512

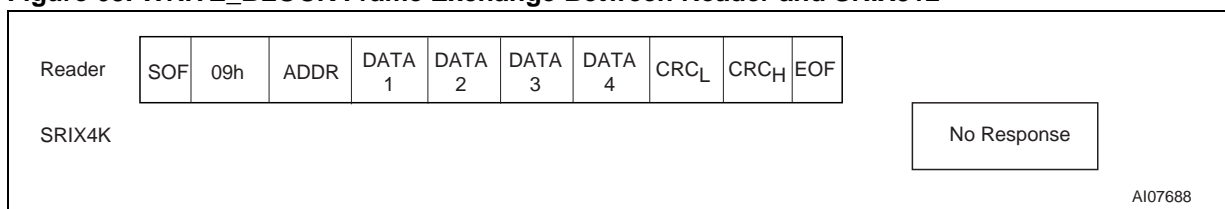
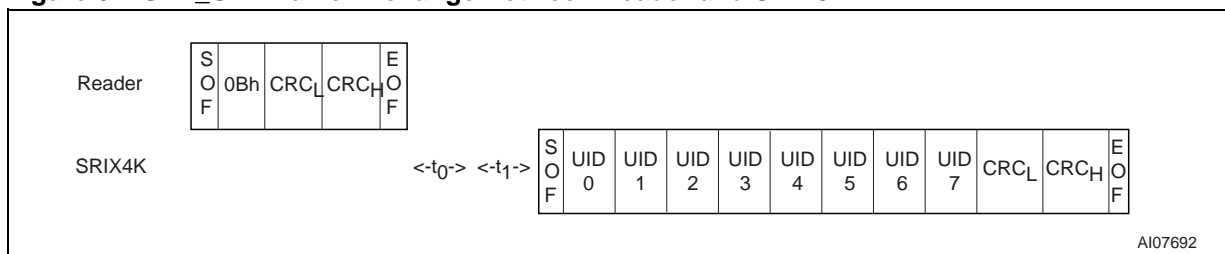

Figure 64. GET_UID Frame Exchange Between Reader and SRIX512



REVISION HISTORY**Table 13. Document Revision History**

Date	Version	Description of Revision
11-Jul-2003	1.0	First Issue
26-Apr-2004	2.0	First public release of full datasheet
29-Nov-2004	3.0	PACKAGE MECHANICAL section revised.
13-Dec-2004	5.0	V_{RET} and C_{TUN} parameters added to Table 7. , DC Characteristics .

Information furnished is believed to be accurate and reliable. However, STMicroelectronics assumes no responsibility for the consequences of use of such information nor for any infringement of patents or other rights of third parties which may result from its use. No license is granted by implication or otherwise under any patent or patent rights of STMicroelectronics. Specifications mentioned in this publication are subject to change without notice. This publication supersedes and replaces all information previously supplied. STMicroelectronics products are not authorized for use as critical components in life support devices or systems without express written approval of STMicroelectronics.

The ST logo is a registered trademark of STMicroelectronics.
All other names are the property of their respective owners

© 2004 STMicroelectronics - All rights reserved

STMicroelectronics group of companies
Australia - Belgium - Brazil - Canada - China - Czech Republic - Finland - France - Germany - Hong Kong - India - Israel - Italy - Japan -
Malaysia - Malta - Morocco - Singapore - Spain - Sweden - Switzerland - United Kingdom - United States of America
www.st.com