

Thick film rectangular

MCR25 (3225 size: 1 / 4W)

●Features

- 1) Made of same material as the general purpose chip resistors (MCR10 / 18).
- 2) Highly reliable chip resistor
Ruthenium oxide resistive material offers superior resistance to the elements.
- 3) Electrodes not corroded by soldering
Suitable for re-flow soldering.
- 4) ROHM resistors have approved ISO-9001 certification.
Design and specifications are subject to change without notice. Carefully check the specification sheet before using or ordering it.

●Ratings

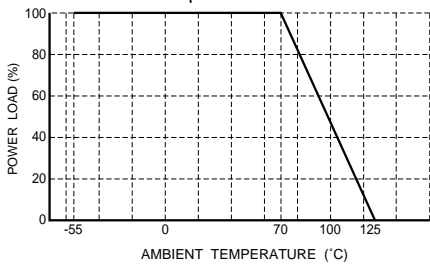
Item	Conditions	Specifications
Rated power	Power must be derated according to the power derating curve in Figure 1 when ambient temperature exceeds 70°C.  <p style="text-align: center;">Fig.1</p>	0.25W (1 / 4W) at 70°C
Rated voltage	The voltage rating is calculated by the following equation. If the value obtained exceeds the limiting element voltage, the voltage rating is equal to the maximum operating voltage. $E = \sqrt{P \times R}$ <div style="display: flex; justify-content: space-between; margin-top: 5px;"> <div>E: Rated voltage (V)</div> <div>P: Rated power (W)</div> <div>R: Nominal resistance (Ω)</div> </div>	Limiting element voltage
Nominal resistance	See Table 1.	200V
Operating temperature		-55°C to +125°C

Jumper type

Resistance	Max. 50mΩ
Rated current	2A
Operating temperature	-55°C to +125°C

Table 1

Resistance tolerance	Resistance range (Ω)	Resistance temperature coefficient (ppm/°C)
F (±1%)	0.1 ≤ R < 10 (E24)	±250
	10 ≤ R ≤ 1M (E24,96)	±200
J (±5%)	0.1 ≤ R < 1 (E24)	±250
	1.0 ≤ R < 2.2 (E24)	500±350
	2.2 ≤ R < 5.6 (E24)	±500
	5.6 ≤ R ≤ 3.3M (E24)	±200

●Before using components in circuits where they will be exposed to transients such as pulse loads (short-duration, high-level loads), be certain to evaluate the component in the mounted state. In addition, the reliability and performance of this component cannot be guaranteed if it is used with a steady state voltage that is greater than its rated voltage.

Resistors

●Characteristics

Item	Guaranteed value		Test conditions (JIS C 5201-1)
	Resistor type	Jumper type	
Resistance	J : $\pm 5\%$ F : $\pm 1\%$	Max. 50m Ω	JIS C 5201-1 4.5
Variation of resistance with temperature	See Table.1		JIS C 5201-1 4.8 Measurement : $-55 / +25 / +125^{\circ}\text{C}$
Overload	$\pm (2.0\%+0.1\Omega)$	Max. 50m Ω	JIS C 5201-1 4.13 Rated voltage (current) $\times 2.5$, 2s. Limiting Element Voltage $\times 2$: 400V
Solderability	A new uniform coating of minimum of 95% of the surface being immersed and no soldering damage.		JIS C 5201-1 4.17 Rosin-Ethanol (25%WT) Soldering condition : $235\pm 5^{\circ}\text{C}$ Duration of immersion : $2.0\pm 0.5\text{s}$.
Resistance to soldering heat	$\pm (1.0\%+0.05\Omega)$ No remarkable abnormality on the appearance.	Max. 50m Ω	JIS C 5201-1 4.18 Soldering condition : $260\pm 5^{\circ}\text{C}$ Duration of immersion : $10\pm 1\text{s}$.
Rapid change of temperature	$\pm (1.0\%+0.05\Omega)$	Max. 50m Ω	JIS C 5201-1 4.19 Test temp. : $-55^{\circ}\text{C}\sim +125^{\circ}\text{C}$ 5cyc
Damp heat, steady state	$\pm (3.0\%+0.1\Omega)$	Max. 100m Ω	JIS C 5201-1 4.24 40°C , 93%RH Test time : 1,000h~1,048h
Endurance at 70°C	$\pm (3.0\%+0.1\Omega)$	Max. 100m Ω	JIS C 5201-1 4.25.1 Rated voltage (current), 70°C 1.5h : ON – 0.5h : OFF Test time : 1,000h~1,048h
Endurance	$\pm (3.0\%+0.1\Omega)$	Max. 100m Ω	JIS C 5201-1 4.25.3 125°C Test time : 1,000h~1,048h
Resistance to solvent	$\pm (1.0\%+0.05\Omega)$	Max. 50m Ω	JIS C 5201-1 4.29 $23\pm 5^{\circ}\text{C}$, Immersion cleaning, $5\pm 0.5\text{min}$. Solvent : 2-propanol
Bend strength of the end face plating	$\pm (1.0\%+0.05\Omega)$ Without mechanical damage such as breaks.	Max. 50m Ω	JIS C 5201-1 4.33

●External dimensions (Units : mm)

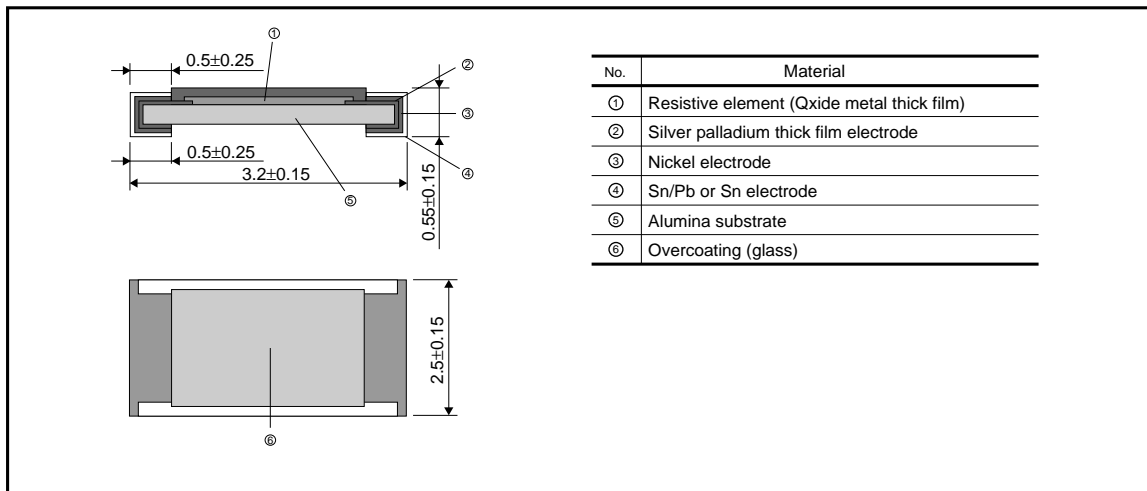

Resistors

●Packaging

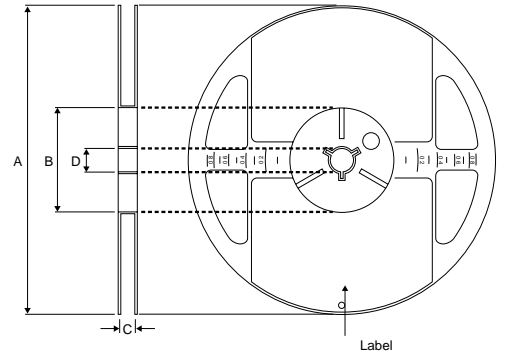
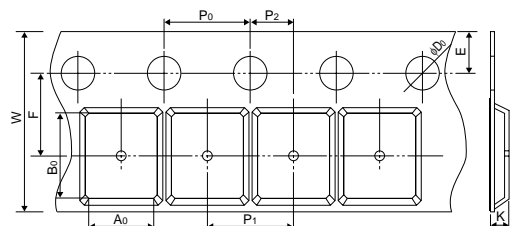
Reel	Taping																												
 <p style="text-align: center;">(Units: mm)</p> <table border="1" style="margin-left: auto; margin-right: auto;"> <tr> <td>A</td> <td>B</td> <td>C</td> <td>D</td> </tr> <tr> <td>$\phi 180 \begin{smallmatrix} 0 \\ -3 \end{smallmatrix}$</td> <td>$\phi 60 \begin{smallmatrix} +1 \\ 0 \end{smallmatrix}$</td> <td>13±0.3</td> <td>$\phi 13 \pm 0.2$</td> </tr> </table>	A	B	C	D	$\phi 180 \begin{smallmatrix} 0 \\ -3 \end{smallmatrix}$	$\phi 60 \begin{smallmatrix} +1 \\ 0 \end{smallmatrix}$	13±0.3	$\phi 13 \pm 0.2$	 <p style="text-align: center;">(Units: mm)</p> <table border="1" style="margin-left: auto; margin-right: auto;"> <tr> <td>W</td> <td>F</td> <td>E</td> <td>A₀</td> <td>B₀</td> </tr> <tr> <td>8.0±0.3</td> <td>3.5±0.05</td> <td>1.75±0.1</td> <td>3.0±0.1</td> <td>3.5±0.1</td> </tr> <tr> <td>D₀</td> <td>P₀</td> <td>P₁</td> <td>P₂</td> <td>K</td> </tr> <tr> <td>$\phi 1.5 \begin{smallmatrix} +0.1 \\ 0 \end{smallmatrix}$</td> <td>4.0±0.1</td> <td>4.0±0.1</td> <td>2.0±0.05</td> <td>Max. 1.1</td> </tr> </table>	W	F	E	A ₀	B ₀	8.0±0.3	3.5±0.05	1.75±0.1	3.0±0.1	3.5±0.1	D ₀	P ₀	P ₁	P ₂	K	$\phi 1.5 \begin{smallmatrix} +0.1 \\ 0 \end{smallmatrix}$	4.0±0.1	4.0±0.1	2.0±0.05	Max. 1.1
A	B	C	D																										
$\phi 180 \begin{smallmatrix} 0 \\ -3 \end{smallmatrix}$	$\phi 60 \begin{smallmatrix} +1 \\ 0 \end{smallmatrix}$	13±0.3	$\phi 13 \pm 0.2$																										
W	F	E	A ₀	B ₀																									
8.0±0.3	3.5±0.05	1.75±0.1	3.0±0.1	3.5±0.1																									
D ₀	P ₀	P ₁	P ₂	K																									
$\phi 1.5 \begin{smallmatrix} +0.1 \\ 0 \end{smallmatrix}$	4.0±0.1	4.0±0.1	2.0±0.05	Max. 1.1																									

●Makeup of the part number

Part No.

M	C	R	2	5		J	Z	H		J				
---	---	---	---	---	--	---	---	---	--	---	--	--	--	--

3-digit or 4-digit IEC coding system

Nominal resistance

Packaging / Processing specifications

Part No.	Code	Packaging	Standard ordering unit(pcs)
MCR25	JZH	Paper tape	4,000

Resistance tolerance

F	±1%	J	±5%
Specify "J" for jumper also.			

special part number

Blank	10Ω or more (F class) 1Ω or more (J class)
L	Up to 10Ω (F class) Up to 1Ω (J class)

●Dimensions

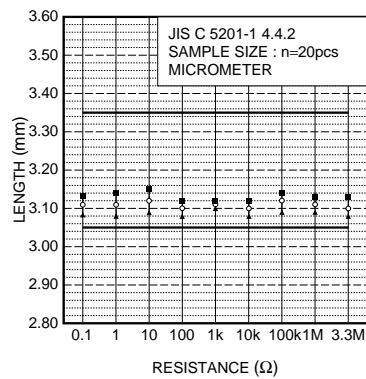

Fig.2 Dimensions (length)

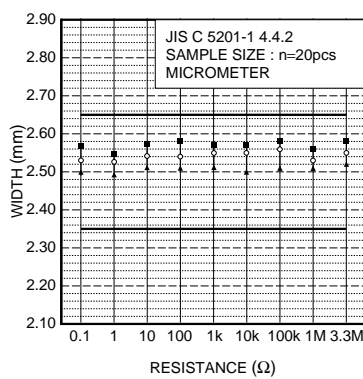

Fig.3 Dimensions (width)

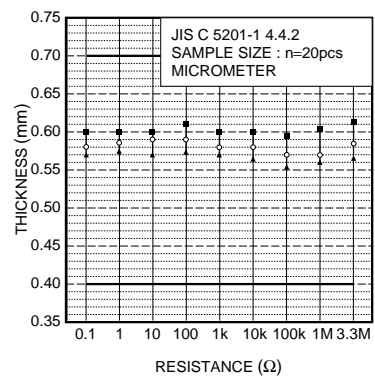

Fig.4 Dimensions (thickness)

Resistors

●Electrical characteristics

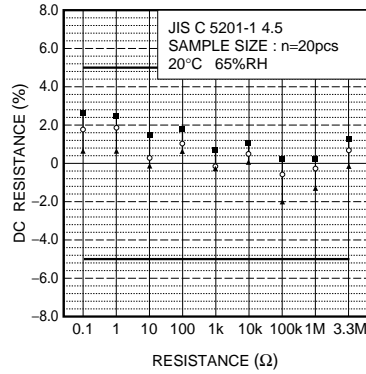

Fig.5 Resistance

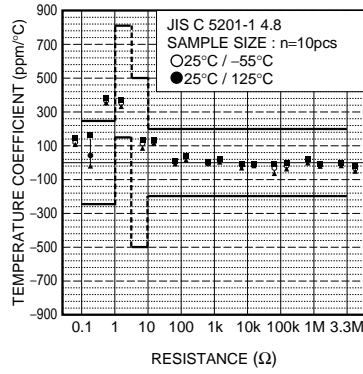

Fig.6 Variation resistance with temperature

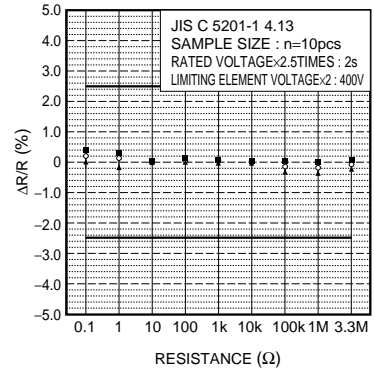

Fig.7 Overload

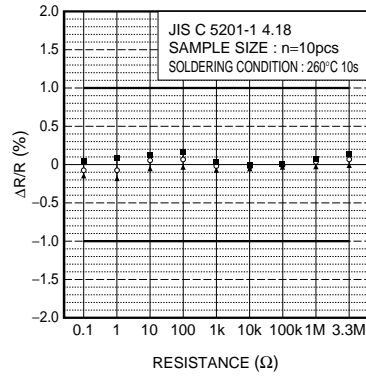

Fig.8 Resistance to soldering heat

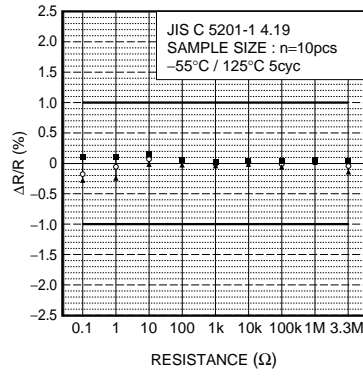

Fig.9 Rapid change of temperature

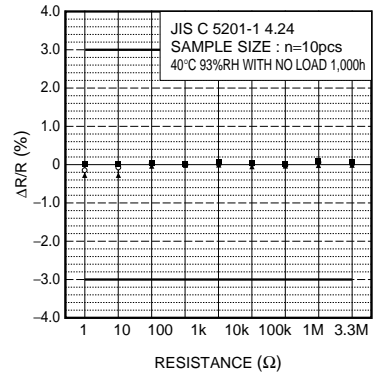

Fig.10 Damp heat, steady state

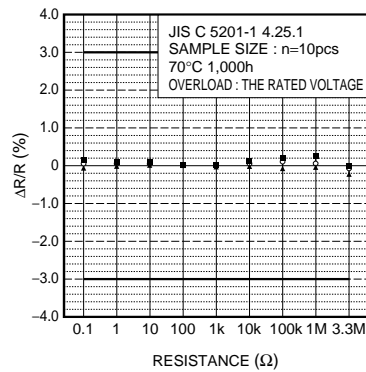

Fig.11 Endurance at 70°C

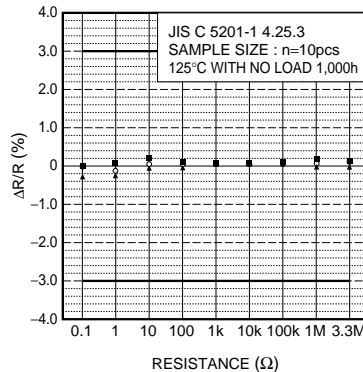

Fig.12 Endurance

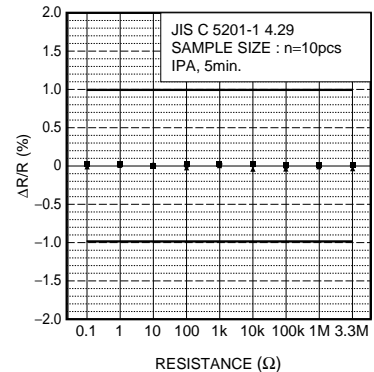

Fig.13 Resistance to solvents

Resistors

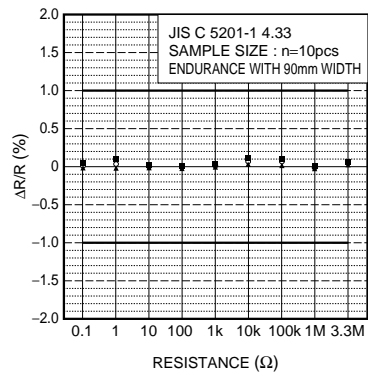

Fig.14 Bend strength of the end face plating