

## Transition Socket Specifications

### INTRODUCTION

This document describes the transition sockets used with MPLAB-ICE, Microchip's in-circuit emulator.

**FIGURE 1: MPLAB-ICE Emulator System**

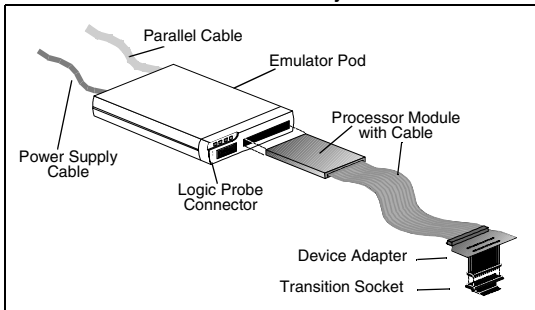

### WHAT ARE TRANSITION SOCKETS?

Transition sockets are devices that allow MPLAB-ICE device adaptors to interface to sockets on customer products that differ from the standard emulator adaptor connection.

Embedded microcontrollers/microprocessors come in many different types of IC packages, i.e., DIP, PLCC, SOIC, SSOP, MQFP, etc. Typically, development cycle components are EPROM based and, as a result, are provided in larger windowed package formats such as DIP or PLCC. Production components are primarily preprogrammed ROM, OTP or Flash-based and are often in very compact SOIC, SSOP, MQFP or PQFP package formats.

The MPLAB-ICE solution is transition sockets. A transition socket is specifically designed to provide compatibility between two differing types of IC package formats.

Transition sockets are typically composed of two parts: the DIP adapter socket and the SOIC/SSOP header. The DIP adapter socket is designed to plug into the emulator system's DIP device adapter on one side and the header on the other. The header is then soldered down to the target application.

The QFP Adapter is a single part soldered directly to the target application and fits into the QFP device adapter.

## WHY SHOULD I USE TRANSITION SOCKETS IN MY PRODUCT DESIGN?

There are two very significant advantages to using transition sockets:

1. A shorter product development cycle, and
2. Reduced expense in the design, layout, and prototype testing.

A typical product design cycle has two important phases: the prototype design phase and the production design phase. Traditionally, these phases were different simply because the prototype used a microcontroller with a different package type. However, with the availability of the transition sockets, the prototype design can be identical to the production design because a transition socket can be used to bridge the microcontroller package differences.

## WHAT ARE THE CURRENTLY AVAILABLE TRANSITION SOCKETS?

Microchip Technology currently offers the following transition sockets for use with our emulator systems:

- PDIP – 28-Lead, 0.300-inch Male to 0.600-inch Female
- SOIC – 8-, 14-, 18-, 20- and 28-Lead
- SSOP – 20- and 28-Lead
- QFP – 44-, 64- and 80-Lead

Please check the Microchip web site ([www.microchip.com](http://www.microchip.com)) for the most current version of this document.

## **HOW CAN I OBTAIN MAXIMUM BENEFIT FROM THE USE OF TRANSITION SOCKETS?**

Attention to component placement should be considered to provide adequate clearance for the transition socket interface to the PCB footprint. This is especially true for any tall components such as connector headers, radial components or voltage regulators. Refer to the transition socket mechanical drawings for dimensions.

## **COMMENTS AND SUGGESTIONS ON TRANSITION SOCKET APPLICATIONS**

Attention to component placement should be considered in mating the adapter sockets to the SOIC/SSOP headers. If visual alignment is difficult in your application, c-shaped end brackets have been included to aid in header-to-adapter socket alignment. Clip the brackets onto the SOIC/SSOP header.

The placement of via's around the Surface Mount Technology (SMT) layout area should be examined. Via's immediately adjacent to the end of a SMT pad may inadvertently come into contact with the header leads. Via's should be placed along the centerline of the SMT pad to lessen the chance of pin to pin shorts while soldering.

The SOIC Header is designed for SOIC body width of 0.300-inch, the adapter leads should be cut to fit the 0.150-inch and 0.208-inch SOIC body widths.

# MPLAB™-ICE

---

## **XLT28XP**

28-Lead DIP 0.300-inch Male to 0.600-inch Female  
Adapter Socket ..... 7

## **XLT08SO**

8-Lead DIP to 0.050-inch Adapter Socket ..... 9  
8-Lead SOIC Header ..... 10

## **XLT14SO**

14-Lead DIP to 0.050-inch Adapter Socket ..... 11  
14-Lead SOIC Header ..... 12

## **XLT18SO**

18-Lead DIP to 0.050-inch Adapter Socket ..... 13  
18-Lead SOIC Header ..... 14

## **XLT20SO1**

20-Lead DIP to 0.050-inch Adapter Socket ..... 15  
20-Lead SOIC Header ..... 16

## **XLT28SO**

28-Lead DIP to 0.050-inch Adapter Socket ..... 17  
28-Lead SOIC Header ..... 18

## **XLT20SS**

18-Lead DIP to 0.8 mm Adapter Socket ..... 20  
20-Lead SSOP Header ..... 21

## **XLT20SS1**

20-Lead DIP to 0.8 mm Adapter Socket ..... 22  
20-Lead SSOP Header ..... 23

## **XLT28SS, XLT28SS2**

28-Lead DIP to 0.8 mm Adapter Socket ..... 24  
28-Lead SSOP Header ..... 25

## **XLT44PT**

44-Lead Transition Socket – Top View ..... 29

44-Lead Transition Socket – Side View ..... 30

## **XLT64PT1, XLT64PT2, XLT80PT**

64/80-Lead Transition Socket – Top View ..... 31

64/80-Lead Transition Socket – Side View ..... 32

## PDIP TRANSITION SOCKET

A PDIP transition socket and associated hardware is shown in Figure 2.

**FIGURE 2: PDIP Transition Socket**

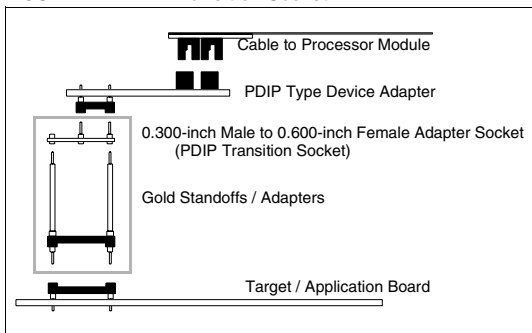

The PDIP transition socket is a 0.300-inch Male to 0.600-inch Female adapter socket.

Microchip offers the following PDIP transition socket:

- XLT28XP: One 28-Lead PDIP adapter socket and two 28-Lead gold stand-offs

See the drawings in this section for layout dimensions.

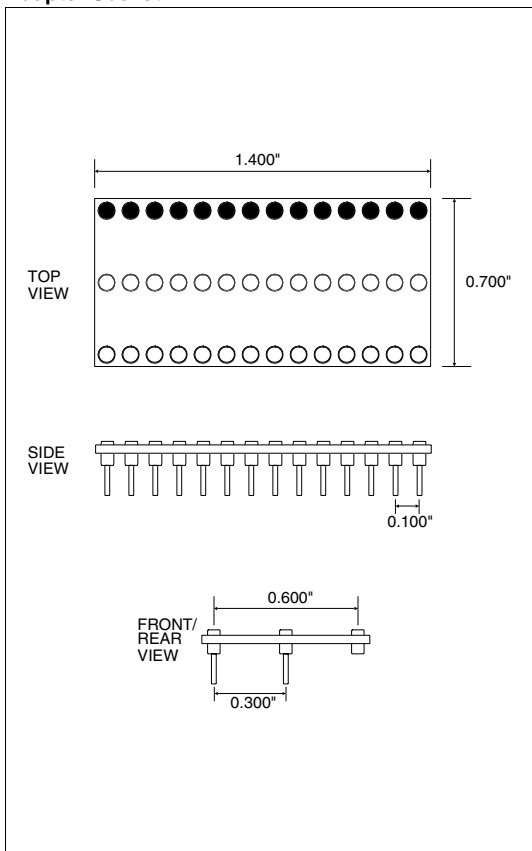
**XLT28XP****28-Lead DIP 0.300-inch Male to 0.600-inch Female Adapter Socket**

## SOIC TRANSITION SOCKET

An SOIC transition socket and associated hardware is shown in Figure 3.

**FIGURE 3: SOIC Transition Socket**

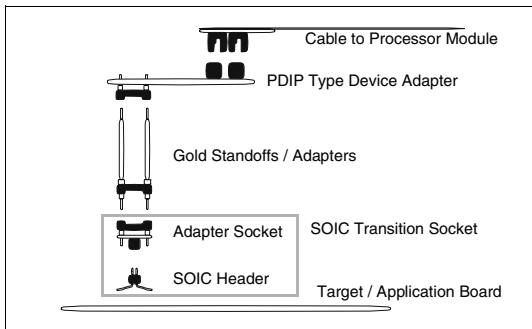

There are two components of the SOIC transition socket.

1. Adapter socket that connects to the PDIP device adapter.
2. SOIC header that is to be soldered down to the target application.

Microchip offers the following SOIC transition sockets:

- XLT08SO: One adapter socket and three 8-Lead SOIC headers
- XLT14SO: One adapter socket and three 14-Lead SOIC headers
- XLT18SO: One adapter socket and three 18-Lead SOIC headers
- XLT20SO1: One adapter socket and three 20-Lead SOIC headers
- XLT28SO: One adapter socket and three 28-Lead SOIC headers

See the drawings in this section for layout dimensions.

**Note:** The SOIC header is designed for SOIC body width of 0.300 inch. The adapter leads should be cut to fit the 0.150-inch and 0.208-inch SOIC body widths.



## XLT08SO

### 8-Lead DIP to 0.050-inch Adapter Socket

TOP  
VIEW

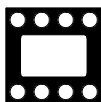

BOTTOM  
VIEW

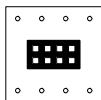

SIDE  
VIEW



FRONT/  
REAR  
VIEW



## 8-Lead SOIC Header

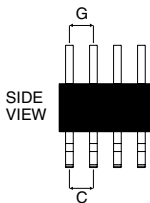
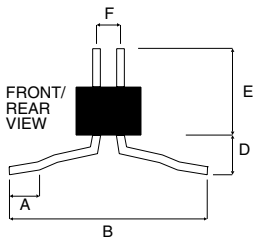
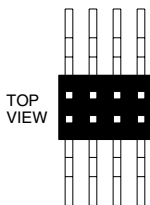

A	B	C	D	E	F	G
0.060	0.410	0.050	0.075	0.178	0.050	0.050

UNLESS OTHERWISE SPECIFIED, DIMENSIONS ARE IN INCHES.

The SOIC header is designed for an SOIC body width of 0.300 inch.

The adapter leads should be cut to fit the 0.150-inch and 0.208-inch SOIC body widths.

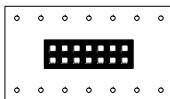
**XLT14SO****14-Lead DIP to 0.050-inch Adapter Socket**TOP  
VIEWBOTTOM  
VIEWSIDE  
VIEWFRONT/  
REAR  
VIEW

## 14-Lead SOIC Header

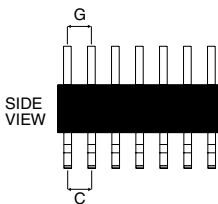
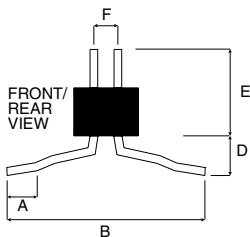
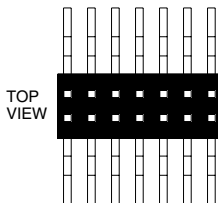

A	B	C	D	E	F	G
0.060	0.410	0.050	0.075	0.178	0.050	0.050

UNLESS OTHERWISE SPECIFIED, DIMENSIONS ARE IN INCHES.

The SOIC header is designed for an SOIC body width of 0.300 inch.

The adapter leads should be cut to fit the 0.150-inch and 0.208-inch SOIC body widths.

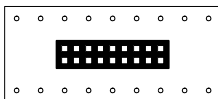
**XLT18SO****18-Lead DIP to 0.050-inch Adapter Socket**TOP  
VIEWBOTTOM  
VIEWSIDE  
VIEWFRONT/  
REAR  
VIEW

## 18-Lead SOIC Header

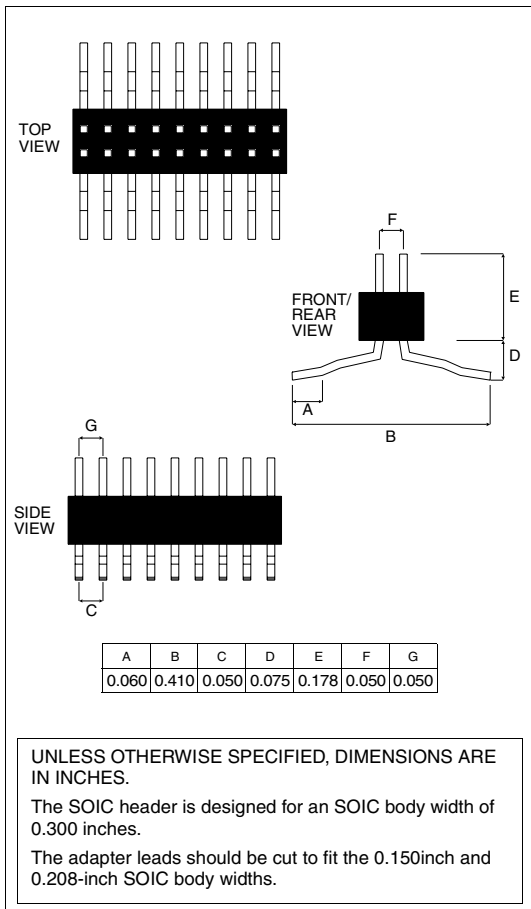

## XLT20SO1

### 20-Lead DIP to 0.050-inch Adapter Socket

TOP  
VIEW



BOTTOM  
VIEW

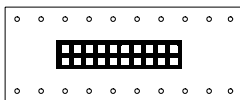

SIDE  
VIEW



FRONT/  
REAR  
VIEW



## 20-Lead SOIC Header

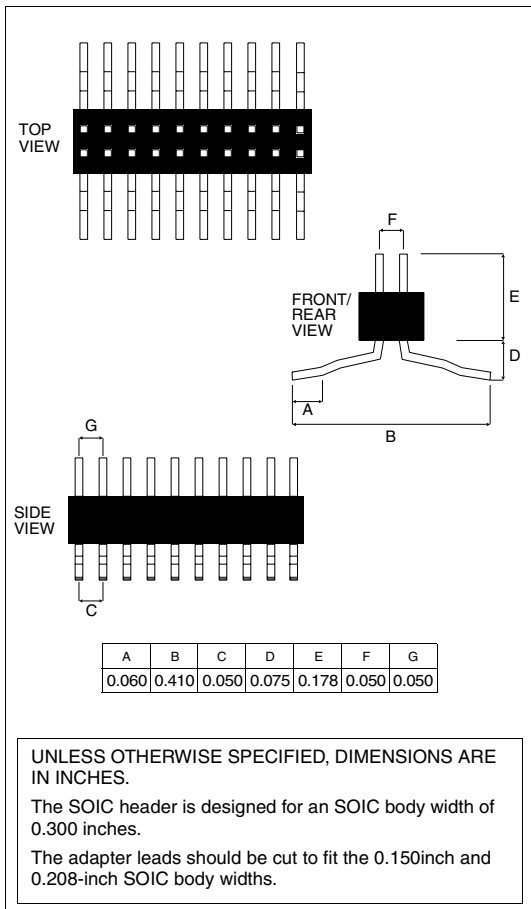

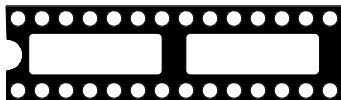
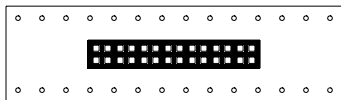

**XLT28SO****28-Lead DIP to 0.050-inch Adapter Socket**TOP  
VIEWBOTTOM  
VIEWSIDE  
VIEWFRONT/  
REAR  
VIEW

## 28-Lead SOIC Header

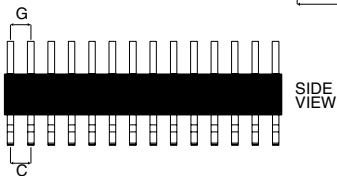
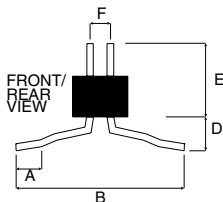
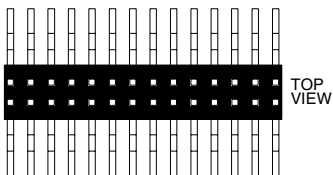

A	B	C	D	E	F	G
0.060	0.410	0.050	0.075	0.178	0.050	0.050

UNLESS OTHERWISE SPECIFIED, DIMENSIONS ARE IN INCHES.

The SOIC header is designed for an SOIC body width of 0.300 inches.

The adapter leads should be cut to fit the 0.150-inch and 0.208-inch SOIC body widths.

## SSOP TRANSITION SOCKET

An SSOP transition socket and associated hardware is shown in Figure 4.

**FIGURE 4: SSOP Transition Socket**

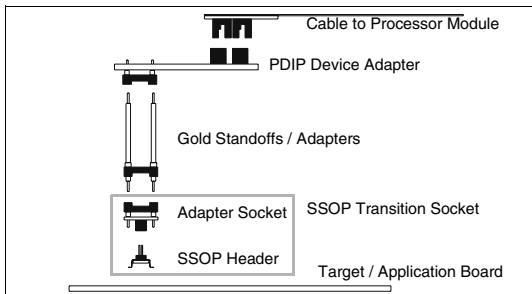

The SSOP transition sockets are similar to the SOIC transition sockets. There are two parts to the SSOP transition socket:

1. Adapter socket that connects to the PDIP device adapter.
2. SSOP header that gets soldered down to the target application.

**Note:** To keep the leads straight during assembly and shipping, the SSOP headers are shipped with break-away tabs attached to the leads. Please remove the break-away tabs before applying power to the target system. Be careful not to bend the leads prior to soldering to the target application.

Microchip offers the following SSOP transition sockets:

- XLT20SS: One adapter socket and three 20-Lead SSOP headers
- XLT20SS1: One adapter socket and three 20-Lead SSOP headers
- XLT28SS: One adapter socket and three 28-Lead SSOP headers
- XLT28SS2: One adapter socket and three 28-Lead SSOP headers for PIC16C55/57.

See the drawings in this section for layout dimensions and clearances for tall components.

## XLT20SS

### 18-Lead DIP to 0.8 mm Adapter Socket

TOP  
VIEW

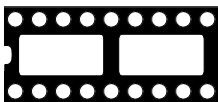

BOTTOM  
VIEW

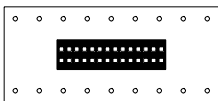

SIDE  
VIEW

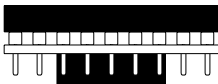

FRONT/  
REAR  
VIEW

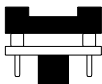

## 20-Lead SSOP Header

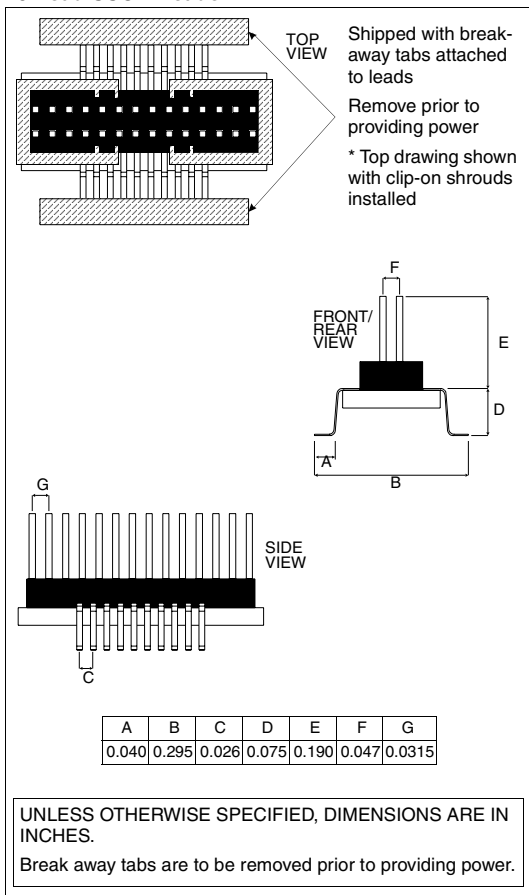

## XLT20SS1

### 20-Lead DIP to 0.8 mm Adapter Socket

TOP  
VIEW



BOTTOM  
VIEW

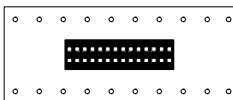

SIDE  
VIEW

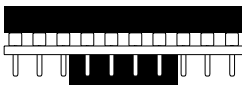

FRONT/  
REAR  
VIEW

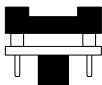

## 20-Lead SSOP Header

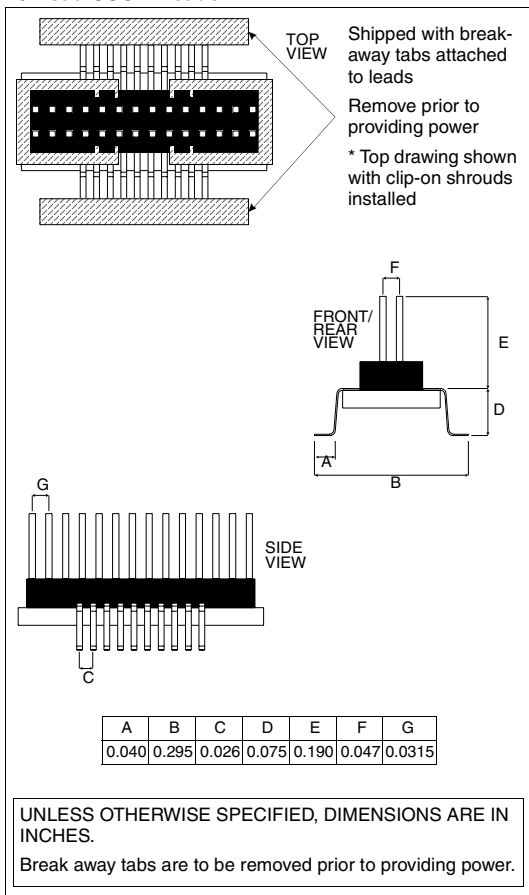

## XLT28SS, XLT28SS2

### 28-Lead DIP to 0.8 mm Adapter Socket

TOP  
VIEW

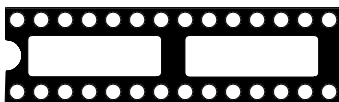

BOTTOM  
VIEW

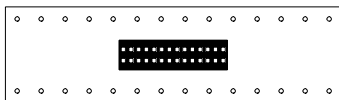

SIDE  
VIEW

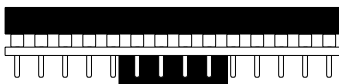

FRONT/  
REAR  
VIEW

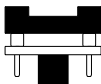



## 28-Lead SSOP Header

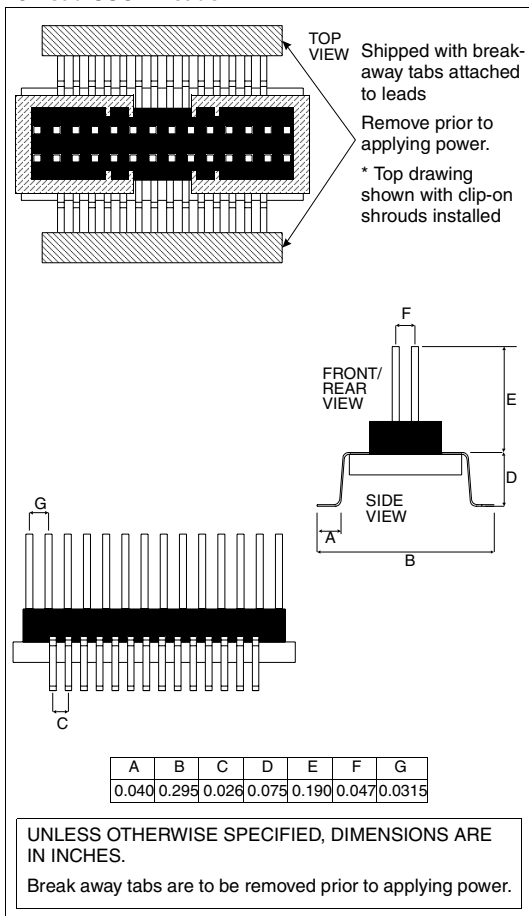

## MQFP/TQFP TRANSITION SOCKET

An MQFP/TQFP transition socket and associated hardware is shown in Figure 5.

**FIGURE 5: MQFP/TQFP Transition Socket**

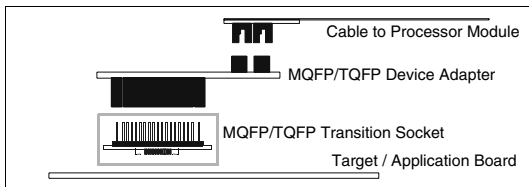

The MQFP/TQFP transition socket is required for use along with the MQFP/TQFP device adapters. The device adapter is equipped with four socket strips that interface with the transition socket.

**Note:** To avoid solder bridging, do not place via's within 0.025-inch of the MQFP/TQFP footprint. Also, any via's near the MQFP/TQFP should be directly on the centerline of the pad.

Microchip offers the following MQFP/TQFP transition sockets:

- XLT44PT: One 44-Lead MQFP/TQFP transition socket
- XLT64PT1 One 64-Lead MQFP/TQFP transition socket, PIC16C92X
- XLT64PT2: One 64-Lead MQFP/TQFP transition socket, PIC17CXXX
- XLT80PT: One 80-Lead MQFP/TQFP transition socket

**Note:** The XLT64PT1 for the PIC16C92X is not symmetrical. Please note Pin 1 orientation prior to soldering to the target system.

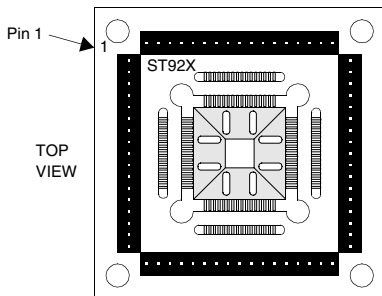

See the drawings in this section for layout dimensions and clearances for tall components.

## TQFP TRANSITION SOCKET SOLDERING TIPS

- Before soldering, consider keeping the break away tabs in place during soldering.
- Use controlled soldering iron tip temperatures between 300 and 325 °C (570 to 615 °F)
- If it is possible, use a PACE mini wave soldering iron tip or an equivalent tip design.
- Plan to solder one (1 of 4) side first, then the opposite side, then remaining two sides.
- Soldering iron tip movement should be in direction of the leads (backward and forward), not across the leads; dragging the tip across the leads may cause lead damage.
- Use generous amounts of soldering flux to aid in the solder flow action.
- If the breakaway tabs are removed after soldering (using a dental pick or equivalent), any solder bridging between leads can be repaired by simply gently touching the soldering tip to the lead tip.

Remember the 64- and 80-pin TQFP headers are very delicate and can be damaged!

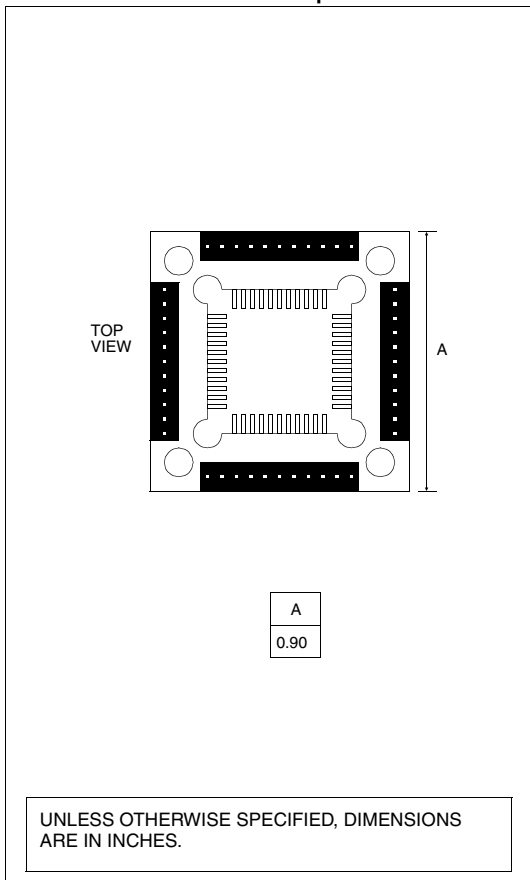
**XLT44PT****44-Lead Transition Socket – Top View**

## 44-Lead Transition Socket – Side View

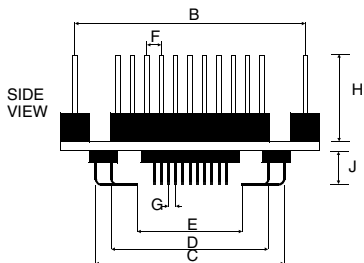

B	C	D	E	F	G	H	J
0.80	0.65	0.55	0.365	0.05	0.80 mm	0.275	0.130

UNLESS OTHERWISE SPECIFIED, DIMENSIONS  
ARE IN INCHES.

## XLT64PT1, XLT64PT2, XLT80PT

## 64/80-Lead Transition Socket – Top View

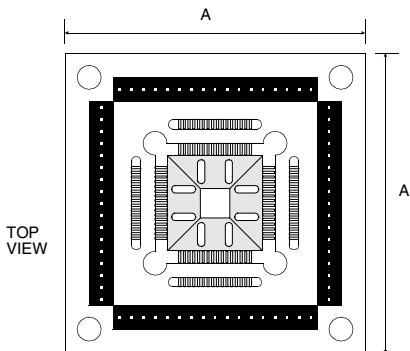

	A
64 Lead	1.25
80 Lead	1.45

UNLESS OTHERWISE SPECIFIED, DIMENSIONS ARE IN INCHES.

Drawing shown is for 64-Lead.

This drawing shown with break away tabs attached to the leads.

Break away tabs are to be removed prior to applying power.

## 64/80-Lead Transition Socket – Side View

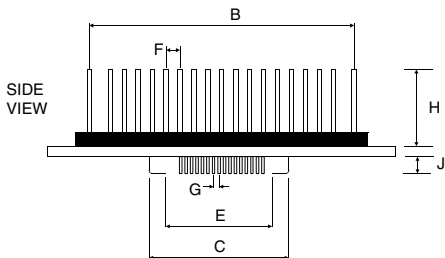

	B	C	E	F	G	H	J
64 Lead	0.95	0.500	0.400	0.05	0.5 mm	0.275	0.095
80 Lead	1.15	0.575	0.475	0.05	0.5 mm	0.275	0.095

UNLESS OTHERWISE SPECIFIED, DIMENSIONS ARE IN INCHES.

Drawing shown is for 64-Lead.

Break away tabs are to be removed prior to applying power.



**NOTES:**

NOTES:

**NOTES:**



---

---

## Worldwide Sales and Service

---

---

### AMERICAS

#### Corporate Office

Tel: 480-786-7200  
Technical Support:  
480-786-7627

#### Atlanta

Tel: 770-640-0034

#### Boston

Tel: 508-480-9990

#### Chicago

Tel: 630-285-0071

#### Dallas

Tel: 972-818-7423

#### Dayton

Tel: 937-291-1654

#### Detroit

Tel: 248-538-2250

#### Los Angeles

Tel: 949-263-1888

#### New York

Tel: 631-273-5305

#### San Jose

Tel: 408-436-7950

#### Toronto

Tel: 905-405-6279

### ASIA/

### PACIFIC

#### China-Beijing

Tel: 86-10-85282100

#### China-Shanghai

Tel: 86-21-6275-5700

#### Hong Kong

Tel: 852-2-401-1200

#### India

Tel: 91-80-229-0061

#### Japan

Tel: 81-45-471- 6166

#### Korea

Tel: 82-2-554-7200

#### Singapore

Tel: 65-334-8870

#### Taiwan

Tel: 886-2-2717-7175

### EUROPE

#### Denmark

Tel: 45-4420-9895

#### France

Tel: 33-1-69-53-63-20

#### Germany

Tel: 49-89-627-144 0

#### Italy

Tel: 39-039-65791-1

#### United Kingdom

Tel: 44 118 921 5858

05/16/00

*Microchip received QS-9000 quality system certification for its worldwide headquarters, design and wafer fabrication facilities in Chandler and Tempe, Arizona in July 1999. The Company's quality system processes and procedures are QS-9000 compliant for its PICmicro<sup>®</sup> 8-bit MCUs, KeELOc<sup>®</sup> code hopping devices, Serial EEPROMs and microperipheral products. In addition, Microchip's quality system for the design and manufacture of development systems is ISO 9001 certified.*

All rights reserved. © 6/00 Microchip Technology Incorporated. Printed in the USA. 6/00 Printed on recycled paper.

Information contained in this publication regarding device applications and the like is intended for suggestion only and may be superseded by updates. No representation or warranty is given and no liability is assumed by Microchip Technology Incorporated with respect to the accuracy or use of such information, or infringement of patents or other intellectual property rights arising from such use or otherwise. Use of Microchip's products as critical components in life support systems is not authorized except with express written approval by Microchip. No licenses are conveyed, implicitly or otherwise, under any intellectual property rights. The Microchip logo and name are registered trademarks of Microchip Technology Inc. in the U.S.A. and other countries. All rights reserved. All other trademarks mentioned herein are the property of their respective companies.