

Surface Mount, Low Current Silicon Bipolar Transistor

Technical Data

AT-60111
AT-60211

Features

- **Low Current Operation**
AT-60111: 0.4 mA at 3 V
AT-60211: 0.8 mA at 3 V
- **Low Noise Figure**
AT-60111: 1.4 dB at 1 GHz
AT-60211: 1.5 dB at 1 GHz
- **High Associated Gain**
AT-60111: 10.5 dB at 1 GHz
AT-60211: 12.5 dB at 1 GHz
- **Low Cost Surface Mount Plastic Package**
- **Tape and Reel Option Available**

Description

The AT-60111 and AT-60211 are low current, low cost NPN silicon bipolar transistors mounted in the surface mount plastic SOT-143 package. These devices are designed for use in gain stages, low noise amplifiers, or oscillators operating in the VHF, UHF, and microwave frequencies, and are ideally suited for battery powered applications.

Excellent device uniformity, performance and reliability are produced by the use of ion-implantation, self-alignment techniques, and gold metallization in the fabrication of these devices.

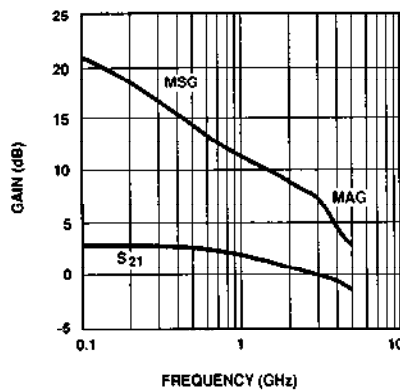

Figure 1. AT-60111 Insertion Power Gain, Maximum Available Gain, and Maximum Stable Gain vs. Frequency, $V_{CE} = 3\text{ V}$, $I_C = 0.4\text{ mA}$.

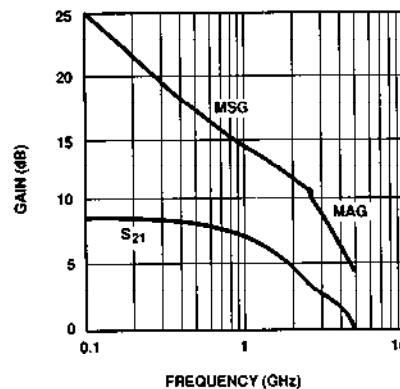
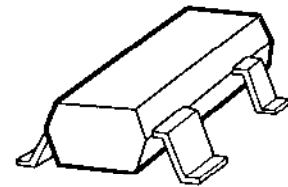
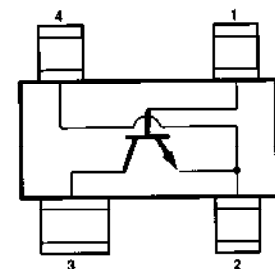

Figure 2. AT-60211 Insertion Power Gain, Maximum Available Gain, and Maximum Stable Gain vs. Frequency, $V_{CE} = 3\text{ V}$, $I_C = 0.8\text{ mA}$.

Plastic SOT-143 Package



Pin Configuration



Pin Description	
1	Base
2	Emitter
3	Collector
4	Emitter

Absolute Maximum Ratings^[1] ($T_A = 25^\circ\text{C}$)

Symbol	Parameter	Units	AT-60111	AT-60211
V_{EBO}	Emitter-Base Voltage	V	1.5	1.5
V_{CBO}	Collector-Base Voltage	V	20	20
V_{CEO}	Collector-Emitter Voltage	V	12	12
I_C	Collector Current	mA	8	16
P_T	Power Dissipation	mW	80 ^[3]	160 ^[4]
T_j	Junction Temperature	$^\circ\text{C}$	150	150
T_{stg}	Storage Temperature	$^\circ\text{C}$	-65 to +150	-65 to +150
θ_{jc}	Thermal Resistance Junction to Case ^[2]	$^\circ\text{C}/\text{W}$	645	610

Notes:

1. Operation in excess of any one of these conditions may result in permanent damage to this device.
2. $T_j = 150^\circ\text{C}$.

3. Derate at 1.55 mW/ $^\circ\text{C}$ for $T_{CASE} > 98^\circ\text{C}$.
4. Derate at 1.64 mW/ $^\circ\text{C}$ for $T_{CASE} > 102^\circ\text{C}$.

Electrical Specifications, $T_A = 25^\circ\text{C}$

Symbol	Parameter	Units	AT-60111			AT-60211		
			Min.	Typ.	Max.	Min.	Typ.	Max.
NF_O	Optimum Noise Figure AT-60111: $V_{CE} = 3\text{ V}$, $I_C = 0.4\text{ mA}$ $f = 1\text{ GHz}$ AT-60211: $V_{CE} = 3\text{ V}$, $I_C = 0.8\text{ mA}$ $f = 1\text{ GHz}$	dB		1.4			1.5	
G_A	Gain at NF_O AT-60111: $V_{CE} = 3\text{ V}$, $I_C = 0.4\text{ mA}$ $f = 1\text{ GHz}$ AT-60211: $V_{CE} = 3\text{ V}$, $I_C = 0.8\text{ mA}$ $f = 1\text{ GHz}$	dB		10.5			12.5	
MSG	Maximum Stable Gain AT-60111: $V_{CE} = 3\text{ V}$, $I_C = 0.4\text{ mA}$ $f = 1\text{ GHz}$ $f = 2\text{ GHz}$ AT-60211: $V_{CE} = 3\text{ V}$, $I_C = 0.8\text{ mA}$ $f = 1\text{ GHz}$ $f = 2\text{ GHz}$	dB		11.5 9.0			14.5 11.5	
S_{21}	Insertion Power Gain AT-60111: $V_{CE} = 6\text{ V}$, $I_C = 2.5\text{ mA}$ $f = 1\text{ GHz}$ $f = 2\text{ GHz}$ AT-60211: $V_{CE} = 6\text{ V}$, $I_C = 5.0\text{ mA}$ $f = 1\text{ GHz}$ $f = 2\text{ GHz}$	dB	9.5	11.5 7.0		12.5	14.0 9.0	
$P_{1\text{ dB}}$	Output Power at 1 dB Gain Compression AT-60111: $V_{CE} = 6\text{ V}$, $I_C = 2.5\text{ mA}$ $f = 1\text{ GHz}$ AT-60211: $V_{CE} = 6\text{ V}$, $I_C = 5.0\text{ mA}$ $f = 1\text{ GHz}$	dBm		4.0			7.5	
$G_{1\text{ dB}}$	1 dB Compressed Gain AT-60111: $V_{CE} = 6\text{ V}$, $I_C = 2.5\text{ mA}$ $f = 1\text{ GHz}$ AT-60211: $V_{CE} = 6\text{ V}$, $I_C = 5.0\text{ mA}$ $f = 1\text{ GHz}$	dB		14.0			18	
f_T	Gain Bandwidth Product AT-60111: $V_{CE} = 6\text{ V}$, $I_C = 2.5\text{ mA}$ AT-60211: $V_{CE} = 6\text{ V}$, $I_C = 5.0\text{ mA}$	GHz		5			6	
h_{fe}	Forward Current Transfer Ratio AT-60111: $V_{CE} = 6\text{ V}$, $I_C = 2.5\text{ mA}$ AT-60211: $V_{CE} = 6\text{ V}$, $I_C = 5.0\text{ mA}$		30	150	300	30	150	300
I_{CBO}	Collector Cutoff Current: $V_{CB} = 6\text{ V}$	μA			0.2			0.2
I_{EBO}	Emitter Cutoff Current: $V_{EB} = 1\text{ V}$	μA			1.0			1.0

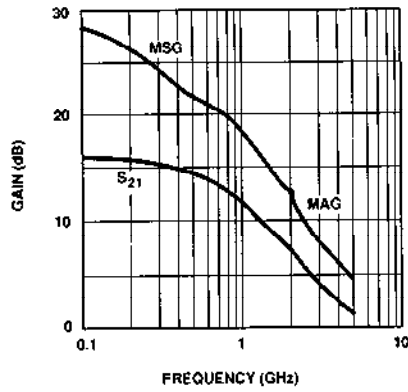

Figure 3. AT-60111 Insertion Power Gain, Maximum Available Gain, and Maximum Stable Gain vs. Frequency, $V_{CE} = 6\text{ V}$, $I_C = 2.5\text{ mA}$.

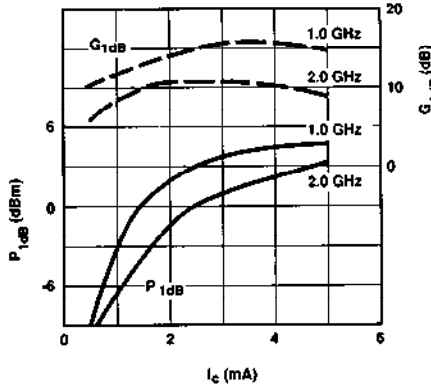

Figure 4. AT-60111 Typical Output Power and 1 dB Compressed Gain vs. Collector Current, $V_{CE} = 6\text{ V}$, $f = 1\text{ GHz}$.

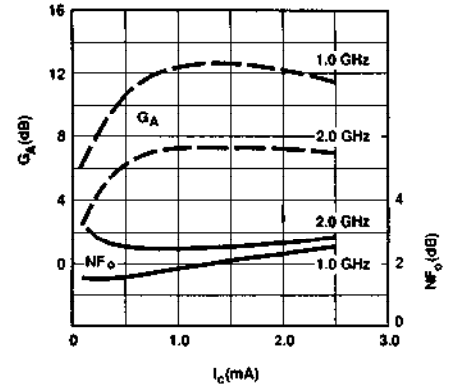

Figure 5. AT-60111 Typical Optimum Noise Figure and Associated Gain vs. Collector Current and Frequency, $V_{CE} = 3\text{ V}$.

AT-60111 Typical S-Parameters ($V_{CE} = 3\text{ V}$, $I_C = 0.4\text{ mA}$)

Freq. (MHz)	S_{11}		S_{21}			S_{12}			S_{22}	
	Mag.	Ang.	(dB)	Mag.	Ang.	(dB)	Mag.	Ang.	Mag.	Ang.
100	.99	-3	2.78	1.38	176	-39.4	.011	85	.99	-3
200	.98	-6	2.81	1.38	171	-34.1	.020	90	.99	-5
500	.97	-15	2.64	1.35	159	-26.8	.046	75	.99	-12
1000	.91	-28	1.92	1.25	140	-21.2	.087	64	.96	-22
1500	.85	-38	1.26	1.16	124	-19.1	.111	58	.93	-29
2000	.78	-45	0.92	1.11	111	-17.3	.137	52	.90	-35
2500	.71	-51	0.40	1.05	101	-15.9	.160	48	.88	-38
3000	.62	-59	0.13	1.01	88	-14.7	.183	41	.85	-44
3500	.53	-68	-0.00	1.00	76	-14.3	.192	37	.81	-51
4000	.45	-79	-0.33	0.96	64	-13.6	.209	30	.79	-57
4500	.37	-90	-0.73	0.92	52	-13.3	.217	25	.77	-64
5000	.32	-102	-1.25	0.87	42	-13.1	.221	20	.77	-70

AT-60111 Typical S-Parameters ($V_{CE} = 6\text{ V}$, $I_C = 2.5\text{ mA}$)

Freq. (MHz)	S_{11}		S_{21}			S_{12}			S_{22}	
	Mag.	Ang.	(dB)	Mag.	Ang.	(dB)	Mag.	Ang.	Mag.	Ang.
100	.93	-8	16.10	6.39	171	-40.1	.010	80	.99	-4
200	.90	-15	15.83	6.19	162	-36.2	.015	72	.98	-8
500	.79	-33	14.59	5.36	138	-29.2	.035	67	.92	-17
1000	.58	-50	11.71	3.85	111	-25.1	.055	56	.84	-26
1500	.44	-58	9.26	2.90	94	-22.7	.074	57	.80	-32
2000	.34	-60	7.23	2.30	81	-20.9	.090	55	.78	-35
2500	.27	-58	5.71	1.93	73	-20.1	.099	55	.76	-37
3000	.21	-55	4.50	1.68	64	-18.9	.114	54	.75	-40
3500	.15	-52	3.60	1.52	53	-17.7	.131	51	.74	-46
4000	.10	-49	2.64	1.35	45	-16.6	.148	47	.73	-52
4500	.07	-33	1.86	1.24	37	-15.7	.164	45	.72	-59
5000	.06	-11	1.03	1.13	28	-15.0	.178	42	.71	-66

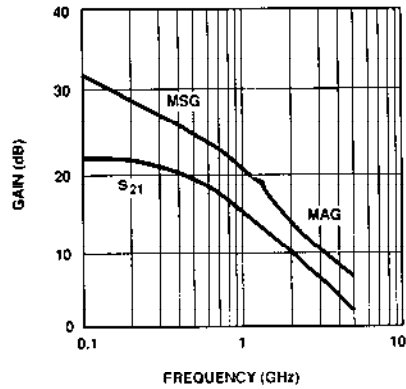

Figure 6. AT-60211 Insertion Power Gain, Maximum Available Gain, and Maximum Stable Gain vs. Frequency, $V_{CE} = 6\text{ V}$, $I_C = 5.0\text{ mA}$.

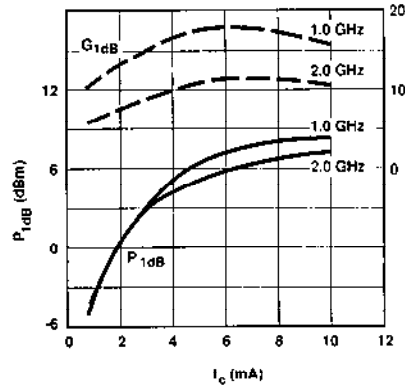

Figure 7. AT-60211 Typical Output Power and 1 dB Compressed Gain vs. Collector Current, $V_{CE} = 6\text{ V}$, $f = 1\text{ GHz}$.

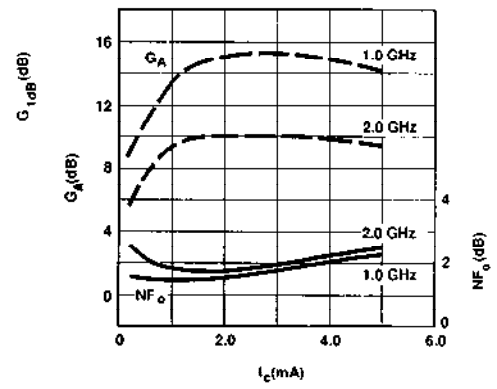

Figure 8. AT-60211 Typical Optimum Noise Figure and Associated Gain vs. Collector Current and Frequency, $V_{CE} = 3\text{ V}$.

AT-60211 Typical S-Parameters ($V_{CE} = 3\text{ V}$, $I_C = 0.8\text{ mA}$)

Freq. (MHz)	S_{11}		S_{21}			S_{12}			S_{22}	
	Mag.	Ang.	(dB)	Mag.	Ang.	(dB)	Mag.	Ang.	Mag.	Ang.
100	.98	-5	8.63	2.70	175	-40.9	.009	93	.99	-4
200	.97	-9	8.52	2.67	170	-34.4	.019	87	.99	-7
500	.93	-22	8.21	2.57	154	-26.2	.049	70	.97	-17
1000	.82	-42	7.08	2.26	131	-21.7	.082	57	.91	-30
1500	.73	-59	5.79	1.95	112	-19.4	.107	46	.86	-40
2000	.64	-72	4.67	1.71	98	-19.1	.111	38	.81	-46
2500	.57	-80	3.58	1.51	87	-18.2	.123	37	.79	-50
3000	.50	-88	2.80	1.38	76	-17.8	.129	34	.77	-57
3500	.41	-95	2.29	1.30	65	-17.7	.131	34	.75	-65
4000	.32	-107	1.68	1.21	53	-17.2	.138	31	.74	-75
4500	.24	-128	0.97	1.12	42	-17.0	.141	30	.73	-83
5000	.21	-160	0.18	1.02	32	-16.8	.144	31	.73	-90

AT-60211 Typical S-Parameters ($V_{CE} = 6\text{ V}$, $I_C = 5.0\text{ mA}$)

Freq. (MHz)	S_{11}		S_{21}			S_{12}			S_{22}	
	Mag.	Ang.	(dB)	Mag.	Ang.	(dB)	Mag.	Ang.	Mag.	Ang.
100	.87	-14	21.65	12.09	168	-41.9	.008	80	.98	-5
200	.82	-26	21.15	11.41	156	-35.8	.016	80	.95	-10
500	.64	-56	18.96	8.87	128	-29.7	.033	59	.85	-19
1000	.41	-87	15.01	5.63	102	-26.6	.047	54	.76	-25
1500	.28	-105	12.13	4.04	86	-25.1	.056	54	.73	-29
2000	.19	-123	9.91	3.13	75	-23.0	.070	56	.71	-32
2500	.14	-147	8.24	2.58	68	-21.9	.080	60	.71	-33
3000	.12	174	6.84	2.20	59	-20.7	.093	58	.69	-36
3500	.15	145	5.66	1.92	50	-19.7	.104	58	.69	-42
4000	.19	129	4.61	1.70	41	-18.8	.115	56	.68	-49
4500	.23	118	3.58	1.51	33	-17.6	.132	53	.68	-55
5000	.26	109	2.71	1.37	25	-16.9	.142	53	.68	-62

Part Number Ordering Information

Part Number	Devices Per Reel	Reel Size
AT-60111-TR1	3000	7"
AT-60111-TR2	10000	13"
AT-60211-TR1	3000	7"
AT-60211-TR2	10000	13"

Package Dimensions SOT-143 Plastic Package

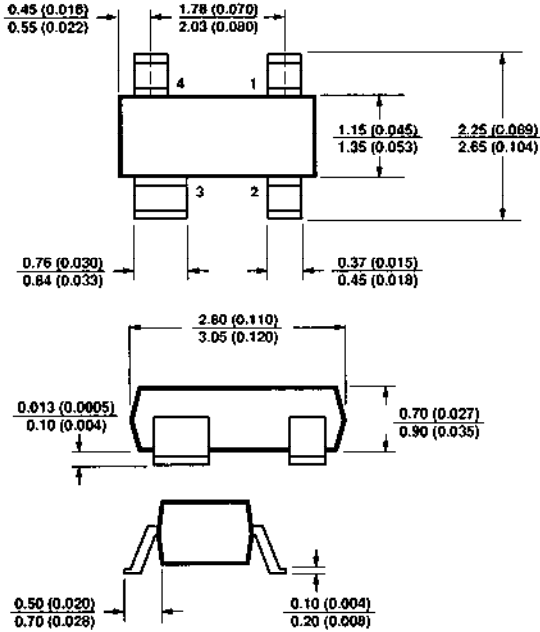

DIMENSIONS ARE IN MM (INCHES).



For more information call:

United States: 1-800-752-0900*

Canada: (416) 678-9430*

Europe: (44) 276-685753*

Asia Pacific/Australia: (65) 290-6360*

Japan: (81 3) 3331-6111*

***Or call your local HP sales office listed
in your telephone directory. Ask for a
Components representative.**

**Data Subject to Change
Copyright © 1992 Hewlett-Packard Co.**

Printed in U.S.A. 5091-4501E (8/92)