

DC Motor Driver

TLE 4201

Bipolar IC

Features

- Max. output current 2.5 A
- Open-loop gain 80 dB typ.
- PNP input stages
- Large common-mode input-voltage range
- Wide control range
- Low saturation voltages
- SOA circuit
- Temperature protection

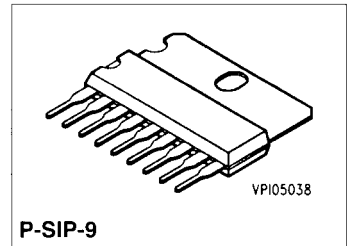
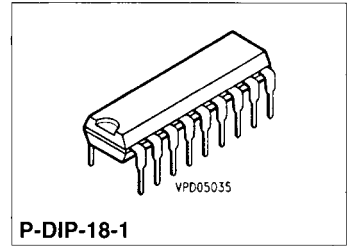

Type	Ordering Code	Package
■ S TLE 4201 A1	Q67000-A8080	P-DIP-18-1
■ S TLE 4201 S1	Q67000-A2285	P-SIP-9

- Not for new design

The TLE 4201 IC is a dual comparator that is particularly suitable for driving reversible DC motors and may also be used as a versatile power driver.

The push-pull power-output stages work in switch mode and can be combined into a full-bridge configuration.

Driving of the comparators may be analog in the form of a window discriminator, or it can be accomplished very simply with digital logic.

Typical applications are follow-up controls, servo drives, servo motors, drive mechanisms, etc.

The TLE 4201 IC comes in two different packages: with the P-SIP-9 package it is possible to remove the heat by way of a cooling fin to a suitable heat sink, whereas with the P-DIP-18-L9 package the pins 10 through 18 are thermally linked to the chip and provide for heat dissipation by way of the circuit board.

www.DataSheet4U.com

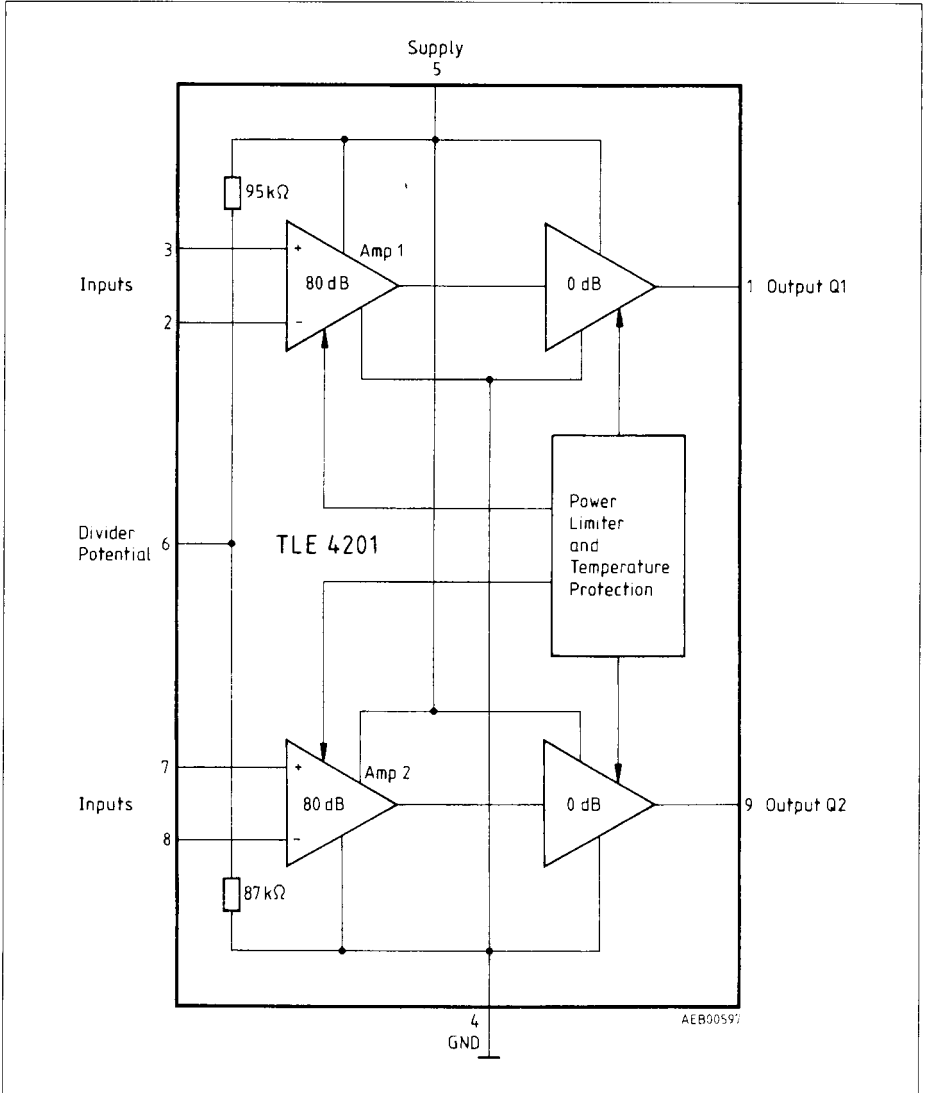

Figure 1 www.DataSheet4U.com
Block Diagram

Pin Definitions and Functions

TLE 4201 A1 Pin	TLE 4201 S1 Pin	Function
1	1	Output of 1st amplifier
2	2	Inverting input of 1st amplifier
3	3	Non-inverting input of 1st amplifier
4	4	Ground
5	5	Supply voltage
6	6	Divider potential
7	7	Non-inverting input of 2nd amplifier
8	8	Inverting input of 2nd amplifier
9	9	Output of 2nd amplifier
10 to 18		Ground; to be connected to pin 4

Circuit Description

The IC contains two amplifiers featuring a typical open-loop voltage gain of 80 dB at 500 Hz. The input stages are PNP differential amplifiers. This results in a common-mode input voltage range from 0 V to almost the value of V_s , and in a maximum input differential voltage of $\pm V_s/2$. To obtain low saturation voltages, the sink transistor (lower transistor) of the push-pull AB output stage is internally bootstrapped. An SOA protective circuit protects the IC against motor short circuits and ground short circuits. An internal overtemperature protection protects the IC against overheating in case of failure due to insufficient cooling or overload.

For logic control, a divider potential of approx. $V_s/2$ is available at pin 6 (see application circuit 2). This makes the IC particularly suitable as power driver for digital circuits.

10

Application

Figure 2 shows a window discriminator operation with the control voltage V_1 .

The window within which the motor is to stop is set by R_2 .

Figure 3 shows driving by logic inputs A and B. The motor is controlled according to the following truth table.

A	B	Output
L	L	Motor stopped (slowed down)
L	H	Motor turns right
H	L	Motor turns left
H	H	Motor stopped (slowed down)

Application Circuits

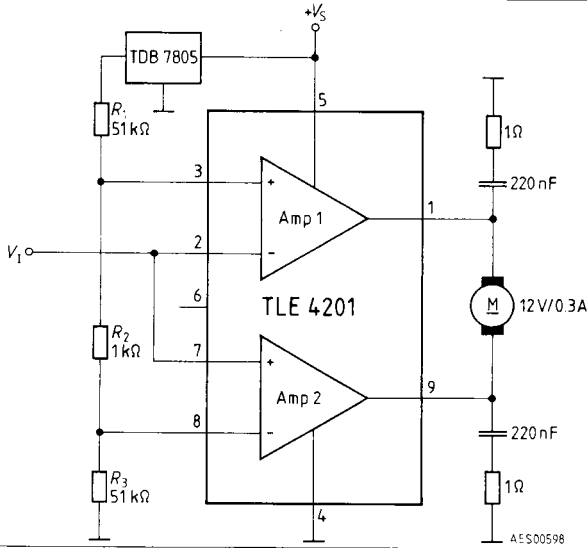

Figure 2
Operated as Window Discriminator
for Input Signals Applies: $H \geq 0.6 V_s$, $L \leq 0.3 V_s$

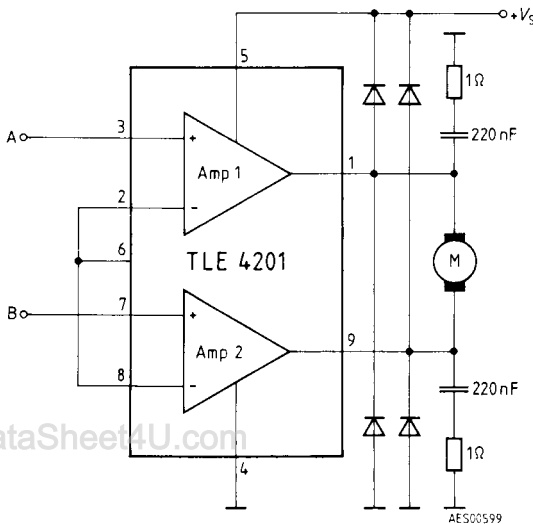

Figure 3
Digital Control

Absolute Maximum Ratings

$T_C = -40$ to 85 °C

Parameter	Symbol	Limit Values		Unit
		min.	max.	
Supply voltage	V_S	–	25	V
Supply voltage ($t \leq 50$ ms)	V_S	–	36	V
Output current	I_O	–	2.5	A
Voltage of pins 2, 3, 6, 7, 8	V	–0.3	V_S	V
Voltage of pins 1, 9	V	–0.3	–	V
Junction temperature	T_j	–	150	°C
Storage temperature	T_{stg}	–55	125	°C
Thermal resistance				
TLE 4201 S1 system - air	R_{thJA}	–	65	K/W
system - case	R_{thJC}	–	8	K/W
TLE 4201 A1 system - air ¹⁾	R_{thJA}	–	60	K/W
system - PC board ¹⁾	R_{thJA1}	–	44 ¹⁾	K/W

Operating Range

Supply voltage	V_S	3.5	17	V
Case temperature	T_C	–40	85	°C
Voltage gain (at negative feedback with external components)	G_V	25	–	dB

Characteristics

$V_S = 13$ V, $T_C = 25$ °C

Parameter	Symbol	Limit Values			Unit	Test Condition	
		min.	typ.	max.			
Supply current	I_S	–	20	30	mA	figure 4: S = 1	
Open-loop voltage gain	G_{V0}	–	80	–	dB	$f = 500$ Hz	
Input resistance	R_I	1	5	–	MΩ	$f = 1$ kHz	
Saturation voltages	V_{Q10}	–	1.0	1.1	V	figure 5: $I_O = 0.3$ A	S = 1 1
Source operation			1.2	1.6	V		
Sink operation	V_{Q20}	–	0.35	0.5	V	$I_O = -0.3$ A	2
			0.7	1.0	V		
Rise time of V_O	t_r	–	1.5	–	μs	figure 4 and 6	
Fall time of V_O	t_f	–	1.5	–	μs		
Turn-ON delay time	t_{ON}	–	3.0	–	μs	figure 4 and 6 figure 4 and 6	
Turn-OFF delay time	t_{OFF}	–	1.5	–	μs		
Input current (pins 2, 3, 7, 8)	I_I	–	1.5	3.0	μA	figure 5, $V_{2,3,7,8} = 0$	
Input offset voltage	V_{I0}	–5	–	5	mV	figure 7	

¹⁾ see figure 8

Test and Measurement Circuits

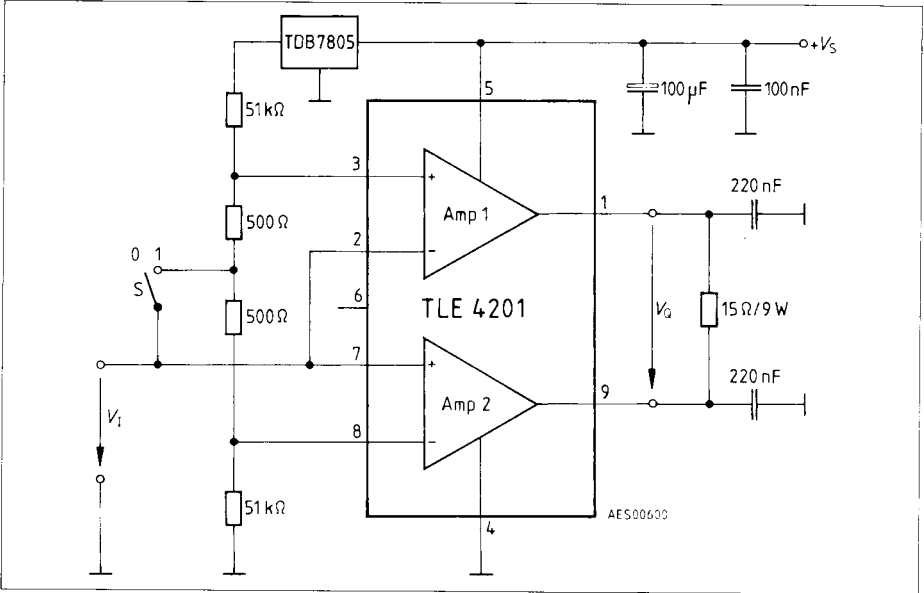

Figure 4

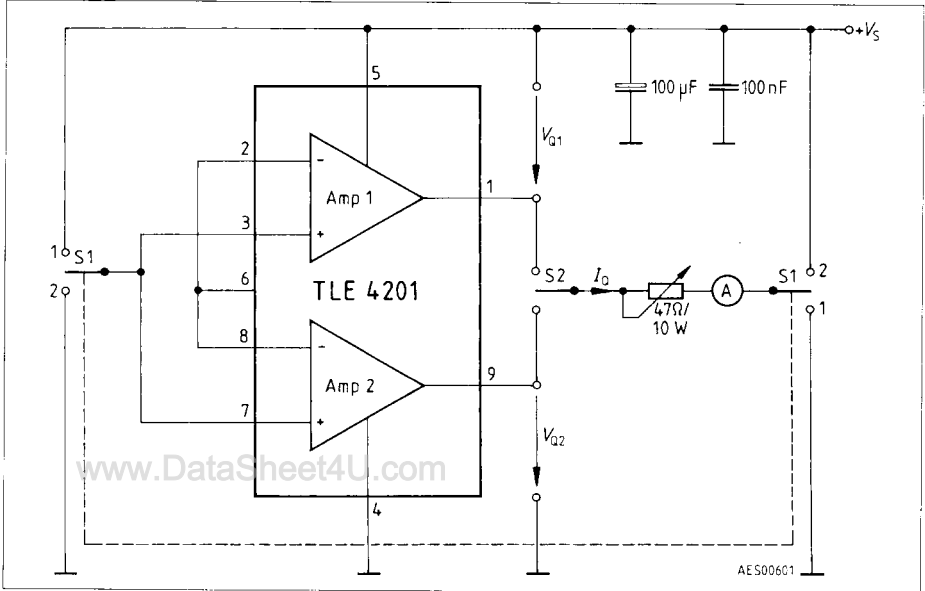

Figure 5

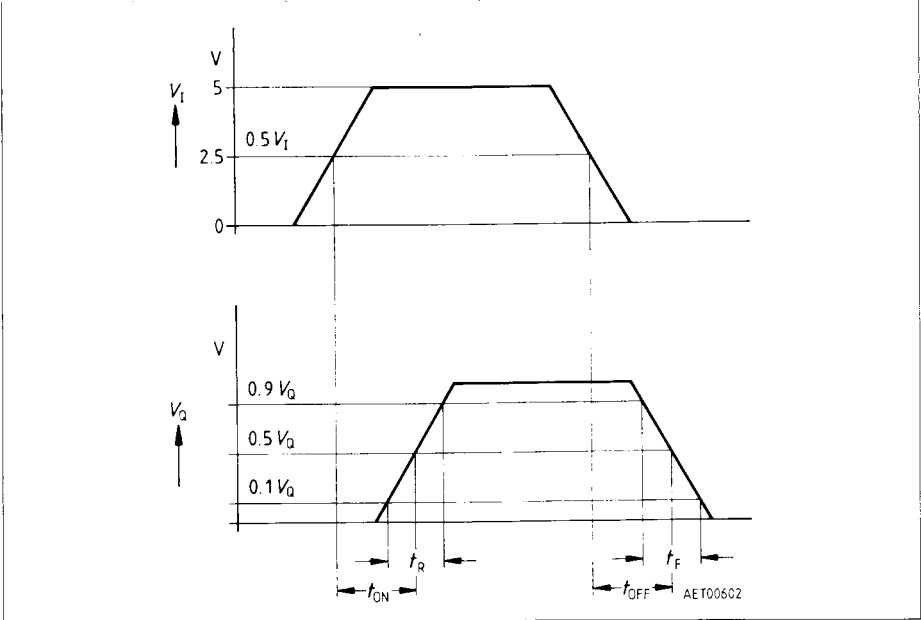

Figure 6
Pulse Diagram

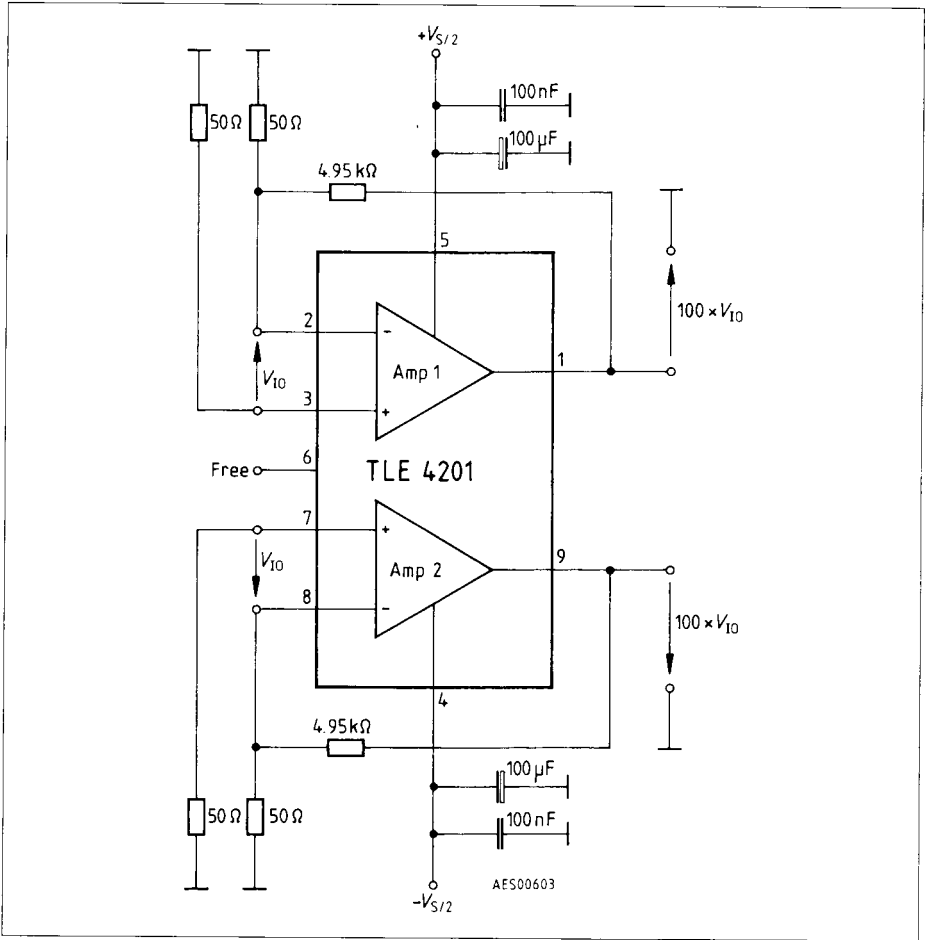

Figure 7
Test and Measurement Circuit
Input Offset Voltages

www.DataSheet4U.com

Thermal Resistance of TLE 4201 A1

Thermal resistance, junction-air, R_{thJA1} (standard) versus side length l of a square copper-clad cooling surface (35 μm copper plate)

- $R_{thJA} (l = 0) = 60 \text{ K/W}$
- $T_A \leq 70 \text{ }^\circ\text{C}$
- $P_V = 1 \text{ W}$
- substrate vertical
- circuit vertical
- still air

Figure 8

