

NEC NEC LCD Technologies, Ltd.

TFT COLOR LCD MODULE

NL6448BC33-50

26cm (10.4 Type)

VGA

DATA SHEET 

DOD-PD-0159 (2nd edition)

**This DATA SHEET is updated document from
DOD-M-1251(1).**

**All information is subject to change without notice.
Please confirm the sales representative before
starting to design your system.**

INTRODUCTION

No part of this document shall be copied in any form or by any means without the prior written consent of NEC LCD Technologies, Ltd. (hereinafter called "NEC").

NEC does not assume any liability for infringement of patents, copyrights or other intellectual property rights of third parties by or arising from use of a product described herein or any other liability arising from use of such application. No license, express, implied or otherwise, is granted under any patents, copyrights or other intellectual property rights of NEC or of others.

While NEC has been making continuous effort to enhance the reliability of its products, the possibility of failures cannot be eliminated entirely. To minimize risks of damage to property or injury to person arising from a failure in an NEC product, customers must incorporate sufficient safety measures in their design, such as redundancy, fire-containment and anti-failure features.

NEC products are classified into the following three quality grades:

"Standard", "Special", "Specific"

The *"Specific"* quality grade applies only to applications developed based on a customer designated "quality assurance program" for a specific application. The recommended applications of a product depend on its quality grade, as indicated below. Customers must check the quality grade of each application before using it in a particular application.

Standard: Computers, office equipment, communications equipment, test and measurement equipment, audio and visual equipment, home electronic appliances, machine tools, personal electronic equipment and industrial robots

Special: Transportation equipment (automobiles, trains, ships, etc.), traffic control systems, anti-disaster systems, anti-crime systems, safety equipment and medical equipment (not specifically designed for life support)

Specific: Military systems, aircraft, aerospace equipment, submersible repeaters, nuclear reactor control systems, life support systems (medical equipment, etc.) and any other equipment

The quality grade of this product is *"Standard"* unless otherwise specified in this document. If customers intend to use this product for applications other than those specified for *"Standard"* quality grade, they should contact NEC sales representative in advance.

CONTENTS

INTRODUCTION	2
1. OUTLINE.....	5
1.1 STRUCTURE AND PRINCIPLE.....	5
1.2 APPLICATIONS.....	5
1.3 FEATURES.....	5
2. GENERAL SPECIFICATIONS	6
3. BLOCK DIAGRAM.....	7
4. DETAILED SPECIFICATIONS	8
4.1 MECHANICAL SPECIFICATIONS.....	8
4.2 ABSOLUTE MAXIMUM RATINGS	8
4.3 ELECTRICAL CHARACTERISTICS	9
4.3.1 Driving for LCD panel signal processing board.....	9
4.3.2 Working for backlight lamp	10
4.3.3 Power supply voltage ripple.....	11
4.3.4 Fuse.....	11
4.4 POWER SUPPLY VOLTAGE SEQUENCE	12
4.4.1 Sequence for LCD panel signal processing board	12
4.4.2 Sequence for backlight inverter (Option).....	12
4.5 CONNECTIONS AND FUNCTIONS FOR INTERFACE PINS.....	13
4.5.1 LCD panel signal processing board	13
4.5.2 Backlight lamp.....	14
4.5.3 Positions of plug and a socket.....	14
4.6 DISPLAY COLORS AND INPUT DATA SIGNALS	15
4.7 DISPLAY POSITIONS.....	16
4.8 SCANNING DIRECTIONS	16
4.9 INPUT SIGNAL TIMINGS FOR LCD PANEL SIGNAL PROCESSING BOARD	17
4.9.1 Outline of input signal timings	17
4.9.2 Timing characteristics	18
4.9.3 Input signal timing chart	20
4.10 OPTICS.....	23
4.10.1 Optical characteristics for transmissive mode.....	23
4.10.2 Definition of contrast ratio	24
4.10.3 Definition of luminance uniformity	24
4.10.4 Definition of response times	24
4.10.5 Definition of viewing angles.....	24
4.10.6 Optical characteristics for reflective mode	25

CONTENTS

5. RELIABILITY TESTS.....26

6. PRECAUTIONS27

6.1 MEANING OF CAUTION SIGNS27

6.3 ATTENTIONS27

6.3.1 Handling of the product27

6.3.2 Environment.....28

6.3.3 Characteristics.....28

6.3.4 Other28

7. OUTLINE DRAWINGS29

7.1 FRONT VIEW29

7.2 REAR VIEW30

1. OUTLINE

1.1 STRUCTURE AND PRINCIPLE

NL6448BC33-50 module is composed of the amorphous silicon thin film transistor liquid crystal display (a-Si TFT LCD) panel structure with driver LSIs for driving the TFT (Thin Film Transistor) array and a backlight.

The a-Si TFT LCD panel structure is injected liquid crystal material into a narrow gap between the TFT array glass substrate and a color-filter glass substrate.

Color (Red, Green, Blue) data signals from a host system (e.g. PC, signal generator, etc.) are modulated into best form for active matrix system by a signal processing board, and sent to the driver LSIs which drive the individual TFT arrays.

The TFT array as an electro-optical switch regulates the amount of transmitted light from the backlight assembly, when it is controlled by data signals. Color images are created by regulating the amount of transmitted light through the TFT array of red, green and blue dots.

1.2 APPLICATIONS

- Industrial PC
- Display terminal for control system

1.3 FEATURES

- Transflective type LCD
- High luminance
- Wide viewing angle
- 6-bit digital RGB signals
- Reversible-scan direction
- Edge light type
- Replaceable lamp for backlight unit (Inverter less)
- Acquisition product for UL60950 3rd edition/CSA C22.2 No.60950 (File number: E170632)

2. GENERAL SPECIFICATIONS

Display area	211.2 (W) × 158.4 (H) mm (typ.)
Diagonal size of display	26.4 cm (10.4 inches)
Drive system	a-Si TFT active matrix
Display color	262,144 colors
Pixel	640 (H) × 480 (V) pixels
Pixel arrangement	RGB (Red dot, Green dot, Blue dot) vertical stripe
Dot pitch	0.1100 (W) × 0.3300 (H) mm
Pixel pitch	0.3300 (W) × 0.3300 (H) mm
Module size	243.0 (W) × 185.1 (H) × 11.0 (D) mm (typ.)
Weight	560 g (typ.)
Contrast ratio	At transmissive mode 100:1 (typ.)
	At reflective mode 8:1 (typ.)
Viewing angle	At transmissive mode, the contrast ratio 10:1 <ul style="list-style-type: none"> • Horizontal: Right side 55° (typ.), Left side 75° (typ.) • Vertical: Up side 40° (typ.), Down side 55° (typ.)
Designed viewing direction	At transmissive mode, DPS= Low or Open: Normal scan <ul style="list-style-type: none"> • Viewing direction without image reversal: down side (6 o'clock) • Viewing direction with contrast peak: down side (6 o'clock) • Viewing angle with optimum grayscale ($\gamma=2.2$): normal axis
Polarizer surface	Clear + Antireflection (AR)
Polarizer pencil-hardness	2H (min.) [by JIS K5400]
Color gamut	At transmissive mode, LCD panel center 50 % (typ.) [against NTSC color space]
	At reflective mode, LCD panel center 30 % (typ.) [against NTSC color space]
Response time	At transmissive mode, Ton (White 90% to black 10%) 5 ms (typ.)
Luminance	At transmissive mode, IBL=5.0mArms / lamp 250 cd/m ² (typ.)
Reflectance	At reflective mode 5.0 % (typ.)
Signal system	6-bit digital signals for data of RGB colors, Dot clock (CLK), Data enable (DE), Horizontal synchronous signal (Hsync), Vertical synchronous signal (Vsync)
Power supply voltage	LCD panel signal processing board: 3.3V or 5.0V
Backlight	Edge light type: 2 cold cathode fluorescent lamps { <ul style="list-style-type: none"> • Replaceable parts • Lamp holder set: Type No. 104LHS38
	{ <ul style="list-style-type: none"> • Recommended inverter (Option) • Inverter: Type No. 104PW161, 104PW191
Power consumption	At IBL=5.0mArms / lamp and checkered flag pattern 6.2W (typ., Power dissipation of the inverter does not include.)

☆

3. BLOCK DIAGRAM

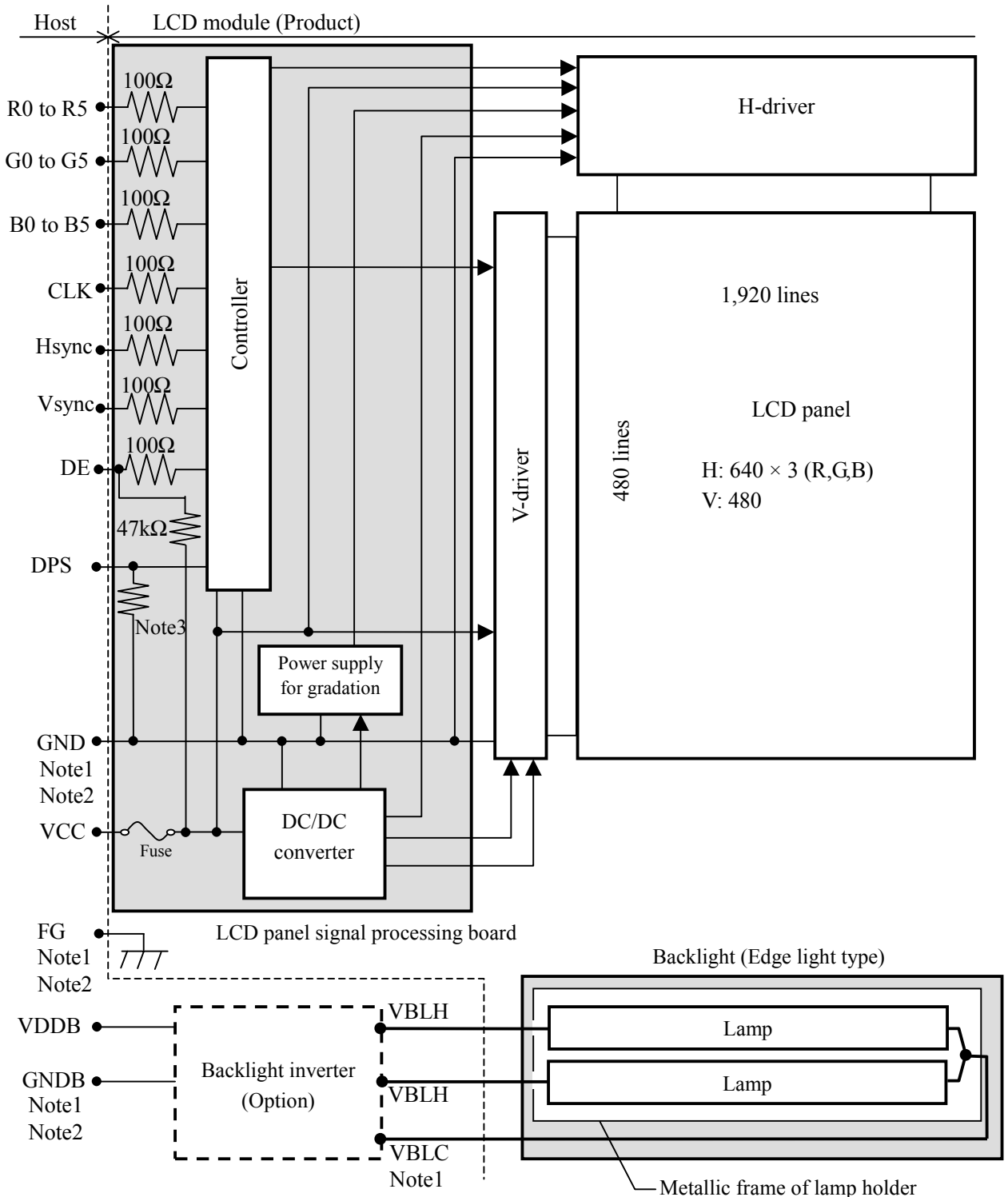

Note1: Connections between GND (Signal ground), FG (Frame ground) and VBLC (Lamp low voltage terminal) in the LCD module

GND - FG	Not connected
GND - VBLC	Not connected
FG - VBLC	Not connected

Note2: GND, FG and GNDB must be connected to customer equipment's ground, and it is recommended that these grounds are connected together in customer equipment.

Note3: Pull-down resistor of DPS pin

Power supply voltage VCC	Pull-down resistor of DPS pin (kΩ)		
	min.	typ.	max.
at 3.3V	6.4	11.4	18.3
at 5.0V	4.5	8.2	14.0

☆

4. DETAILED SPECIFICATIONS

4.1 MECHANICAL SPECIFICATIONS

Parameter	Specification	Unit
Module size	243.0 ± 0.5 (W) × 185.1 ± 0.5 (H) × 11.0 ± 0.5 (D) Note1	mm
Display area	211.2 (W) × 158.4 (H) Note1	mm
Weight	560 (typ.), 590 (max.)	g

Note1: See "7. OUTLINE DRAWINGS".

4.2 ABSOLUTE MAXIMUM RATINGS

Parameter		Symbol	Rating	Unit	Remarks
Power supply voltage	LCD panel signal processing board	VCC	-0.3 to +6.5	V	Ta = 25°C
	Lamp voltage	VBLH	1,500	Vrms	
Input voltage for signals	Display signals Note1	VD	-0.3 to VCC+0.3	V	
	Function signals Note2	VF	-0.3 to VCC+0.3	V	
Incident light intensity		II	150,000	lx	Note3
Storage temperature		Tst	-20 to +80	°C	-
Operating temperature	Front surface	TopF	0 to +65	°C	Note4
	Rear surface	TopR	0 to +70	°C	Note5
Relative humidity Note6		RH	≤ 95	%	Ta ≤ 40°C
			≤ 85	%	40 < Ta ≤ 50°C
			≤ 70	%	50 < Ta ≤ 55°C
			≤ 60	%	55 < Ta ≤ 60°C
			≤ 50	%	60 < Ta ≤ 65°C
Absolute humidity Note6		AH	≤ 80 Note7	g/m ³	Ta > 65°C

Note1: Display signals are CLK, Hsync, Vsync, DE and DATA (R0 to R5, G0 to G5, B0 to B5).

Note2: Function signal is DPS.

Note3: If an ultraviolet ray is directly irradiated to the product surface (polarizer), the polarizer may discolor (Surface treatment may be damaged.). Use a filter to protect the polarizer from the ultraviolet ray.

Note4: Measured at center of LCD panel surface (including self-heat)

Note5: Measured at center of LCD module's rear shield surface (including self-heat)

Note6: No condensation

Note7: Ta = 65°C, RH = 50%

4.3 ELECTRICAL CHARACTERISTICS

4.3.1 Driving for LCD panel signal processing board

(Ta = 25°C)

Parameter	Symbol	min.	typ.	max.	Unit	Remarks
Power supply voltage	VCC	3.0	3.3	3.6	V	for 3.3V system
		4.75	5.0	5.25	V	for 5.0V system
Power supply current	ICC	-	310 Note1	500 Note2	mA	VCC = 3.3V
		-	210 Note1	330 Note2	mA	VCC = 5.0V
Permissible ripple voltage	VRP	-	-	100	mV	for VCC
Logic input voltage for display signals	Low	VDL	0	-	0.3VCC	CMOS level
	High	VDH	0.7VCC	-	VCC	
Input voltage for DPS signal	Low	VFL	0	-	0.4	-
	High	VFH	0.7VCC	-	VCC	

Note1: Checkered flag pattern [by EIAJ ED-2522]

Note2: Pattern for maximum current

☆

4.3.2 Working for backlight lamp

(Ta=25°C Note1)

Parameter	Symbol	min.	typ.	max.	Unit	Remarks
Lamp current	IBL	2.0	5.0	5.5	mArms	at IBL=5.0mArms: 250cd/m ² Note3, Note4
Lamp voltage	VBLH	-	520	-	Vrms	Note2, Note3
Lamp starting voltage	VS	850	-	-	Vrms	Ta = 25°C Note2, Note3
		1100	-	-	Vrms	Ta = 0°C Note2, Note3
Oscillation frequency	FO	50	-	70	kHz	Note5

Note1: This product consists of 2 backlight lamps, and these specifications are for each lamp.

Note2: The lamp voltage cycle between lamps should be kept on a same phase. "VS" and "VBLH" are the voltage value between low voltage side (Cold) and high voltage side (Hot).

Note3: The asymmetric ratio of working waveform for lamps (Lamp voltage peak ratio, Lamp current peak ratio and waveform space ratio) should be less than 5 % (See the following figure.). If the waveform is asymmetric, DC (Direct current) element apply into the lamp. In this case, a lamp lifetime may be shortened, because a distribution of a lamp enclosure substance inclines toward one side between low voltage terminal (Cold terminal) and high voltage terminal (Hot terminal).

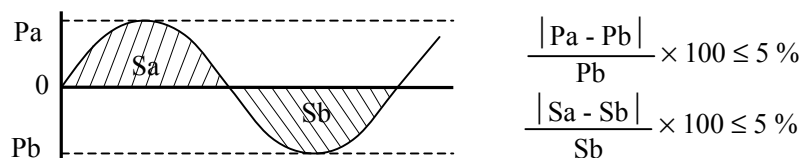

Pa: Supply voltage/current peak for positive, Pb: Supply voltage/current peak for negative
Sa: Waveform space for positive part, Sb: Waveform space for negative part

Note4: 2 backlight lamps contain in 1 lamp holder, and both lamps are connected to 1 low voltage cable. Lamp current must be 5.0mArms typical for each lamp, and sum of 2 lamps must be 10.0mArms typical. The lamp current should be measured by high-frequency current meter at the low voltage terminal.

Note5: In case "FO" is not the recommended value, beat noise may display on the screen, because of interference between "FO" and "1/th". Recommended value of "FO" is as following.

$$FO = \frac{1}{4} \times \frac{1}{th} \times (2n-1)$$

th: Horizontal synchronous cycle (See "4.9.2 Timing characteristics".)

n: Natural number (1, 2, 3)

Note6: Method of lamp cable installation may invite fluctuation of lamp current and voltage or asymmetric of lamp working waveform. When design the backlight inverter, evaluate the fluctuation of lamp current and voltage or asymmetric of lamp working waveform sufficiently.

4.3.3 Power supply voltage ripple

This product works, even if the ripple voltage levels are beyond the permissible values as following the table, but there might be noise on the display image.

Parameter	Power supply voltage	Ripple voltage (Measure at input terminal of power supply)	Note1 (of power supply)	Unit
VCC	3.3 V	≤ 100		mVp-p
	5.0 V	≤ 100		mVp-p

Note1: The permissible ripple voltage includes spike noise.

4.3.4 Fuse

Parameter	Fuse		Rating	Fusing current	Remarks
	Type	Supplier			
VCC	TF16N2.50TE	KOA Corporation	2.5 A	5.0 A	Note1
			32 V		

Note1: The power supply capacity should be more than the fusing current. If the power supply capacity is less than the fusing current, the fuse may not blow for a short time, and then nasty smell, smoking and so on may occur.

4.4 POWER SUPPLY VOLTAGE SEQUENCE

4.4.1 Sequence for LCD panel signal processing board

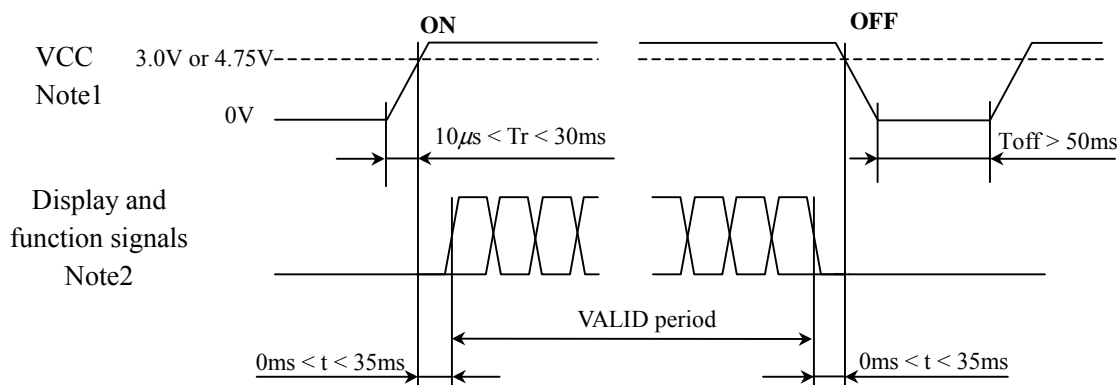

Note1: In terms of voltage variation (voltage drop) while VCC rising edge is below 3.0V in "VCC = 3.3V" or 4.75V in "VCC = 5.0V", a protection circuit may work, and then this product may not work.

Note2: Display (CLK, Hsync, Vsync, DE, R0 to R5, G0 to G5, B0 to B5) and function (DPS) signals must be Low or High-impedance, exclude the VALID period (See above sequence diagram), in order to avoid that internal circuits is damaged.

If some of display and function signals of this product are cut while this product is working, even if the signal input to it once again, it might not work normally. If customer stops the display and function signals, they should be cut VCC.

4.4.2 Sequence for backlight inverter (Option)

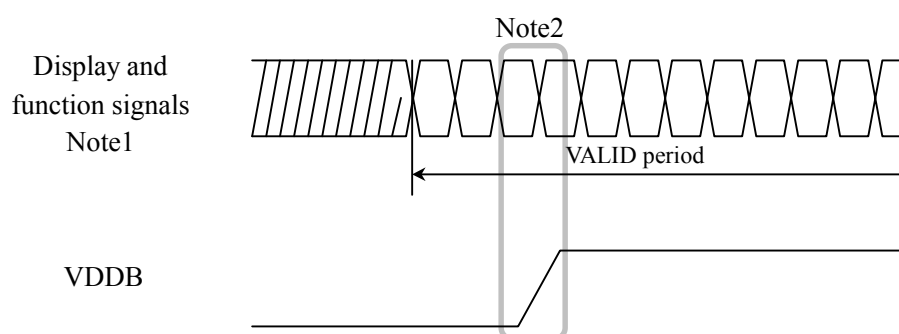

Note1: These are display and function signals for LCD panel signal processing board.

Note2: The backlight inverter voltage (VDDDB) should be inputted within the valid period of display and function signals, in order to avoid unstable data display.

4.5 CONNECTIONS AND FUNCTIONS FOR INTERFACE PINS

4.5.1 LCD panel signal processing board

CN1 socket (LCD module side) : DF9C-31P-1V (Hirose Electric Co., Ltd.)

Adaptable plug : DF9-31S-1V (Hirose Electric Co., Ltd.)

Pin No.	Symbol	Signal	Remarks
1	GND	Ground	
2	CLK	Dot clock	
3	Hsync	Horizontal synchronous	-
4	Vsync	Vertical synchronous	
5	GND	Ground	
6	R0	Red data (LSB)	LSB: Least significant bit
7	R1	Red data	
8	R2	Red data	-
9	R3	Red data	
10	R4	Red data	
11	R5	Red data (MSB)	MSB: Most significant bit
12	GND	Ground	-
13	G0	Green data (LSB)	LSB: Least significant bit
14	G1	Green data	
15	G2	Green data	-
16	G3	Green data	
17	G4	Green data	
18	G5	Green data (MSB)	MSB: Most significant bit
19	GND	Ground	-
20	B0	Blue data (LSB)	LSB: Least significant bit
21	B1	Blue data	
22	B2	Blue data	-
23	B3	Blue data	
24	B4	Blue data	
25	B5	Blue data (MSB)	MSB: Most significant bit
26	GND	Ground	-
27	DE	Selection of DE / Fixed mode	Data enable signal: DE mode High or Open: Fixed mode
28	VCC	Power supply	
29	VCC	Power supply	-
30	N.C.	Non connection	
31	DPS	Selection of scan direction	High: Reverse scan Low or Open: Normal scan Note1

Note1: See "4.8 SCANNING DIRECTIONS".

4.5.2 Backlight lamp

Attention: VBLH and VBLC must be connected correctly. If customer connects wrongly, customer will be hurt and the module will be broken.

CN2 plug (LCD module side) : BHR-03VS-1 (J.S.T Mfg. Co., Ltd.)

Adaptable socket : SM03 (4.0) B-BHS-1-TB (J.S.T Mfg. Co., Ltd.)

Pin No.	Symbol	Signal	Remarks
1	VBLC	Low voltage (Cold)	Cable color: White
2	VBLH	High voltage (Hot)	Cable color: Pink
3	VBLH	High voltage (Hot)	Cable color: Pink

4.5.3 Positions of plug and a socket

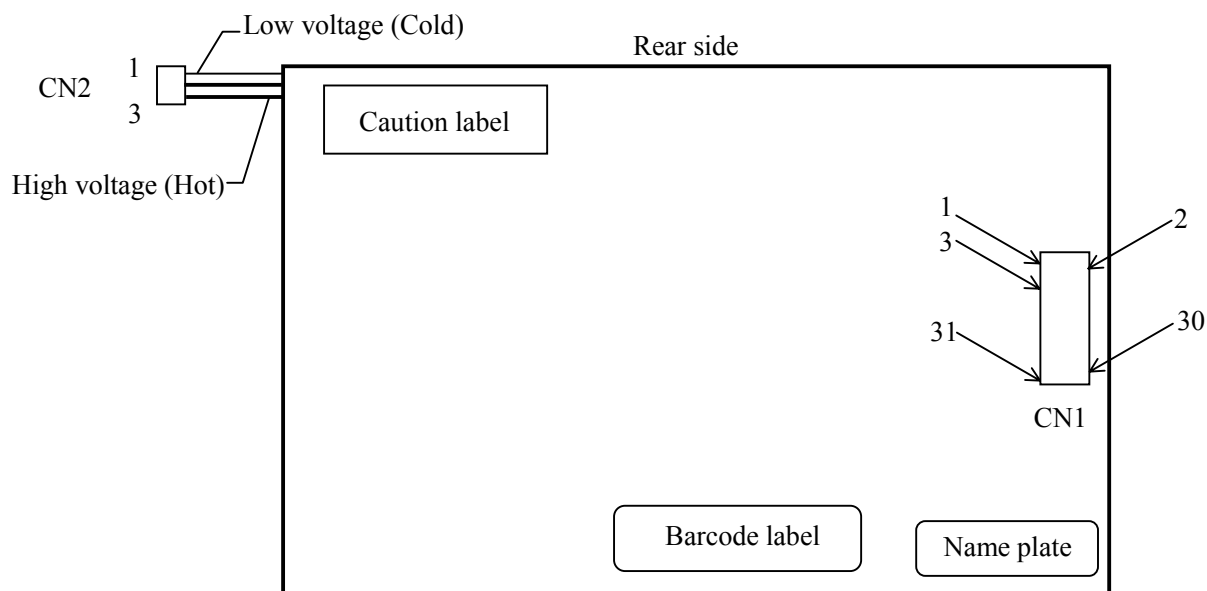

4.6 DISPLAY COLORS AND INPUT DATA SIGNALS

This product can display in equivalent to 262,144 colors in 64 scale. Also the relation between display colors and input data signals is as the following table.

Display colors		Data signal (0: Low level, 1: High level)																	
		R 5	R 4	R 3	R 2	R 1	R 0	G 5	G 4	G 3	G 2	G 1	G 0	B 5	B 4	B 3	B 2	B 1	B 0
Basic colors	Black	0	0	0	0	0	0	0	0	0	0	0	0	0	0	0	0	0	0
	Blue	0	0	0	0	0	0	0	0	0	0	0	1	1	1	1	1	1	1
	Red	1	1	1	1	1	1	0	0	0	0	0	0	0	0	0	0	0	0
	Magenta	1	1	1	1	1	1	0	0	0	0	0	1	1	1	1	1	1	1
	Green	0	0	0	0	0	0	1	1	1	1	1	1	0	0	0	0	0	0
	Cyan	0	0	0	0	0	0	1	1	1	1	1	1	1	1	1	1	1	1
	Yellow	1	1	1	1	1	1	1	1	1	1	1	1	0	0	0	0	0	0
	White	1	1	1	1	1	1	1	1	1	1	1	1	1	1	1	1	1	1
Red scale	Black	0	0	0	0	0	0	0	0	0	0	0	0	0	0	0	0	0	0
		0	0	0	0	0	1	0	0	0	0	0	0	0	0	0	0	0	0
	dark	0	0	0	0	1	0	0	0	0	0	0	0	0	0	0	0	0	0
	↑				:														
	↓				:														
	bright	1	1	1	1	0	1	0	0	0	0	0	0	0	0	0	0	0	0
	1	1	1	1	1	0	0	0	0	0	0	0	0	0	0	0	0	0	
	1	1	1	1	1	1	0	0	0	0	0	0	0	0	0	0	0	0	
Green scale	Black	0	0	0	0	0	0	0	0	0	0	0	0	0	0	0	0	0	0
		0	0	0	0	0	0	0	0	0	0	1	0	0	0	0	0	0	0
	dark	0	0	0	0	0	0	0	0	0	1	0	0	0	0	0	0	0	0
	↑				:														
	↓				:														
	bright	0	0	0	0	0	0	1	1	1	1	0	1	0	0	0	0	0	0
	0	0	0	0	0	0	1	1	1	1	1	0	0	0	0	0	0	0	
	0	0	0	0	0	0	1	1	1	1	1	1	0	0	0	0	0	0	
Blue scale	Black	0	0	0	0	0	0	0	0	0	0	0	0	0	0	0	0	0	0
		0	0	0	0	0	0	0	0	0	0	0	0	0	0	0	0	0	1
	dark	0	0	0	0	0	0	0	0	0	0	0	0	0	0	0	0	1	0
	↑				:														
	↓				:														
	bright	0	0	0	0	0	0	0	0	0	0	0	0	1	1	1	1	0	1
	0	0	0	0	0	0	0	0	0	0	0	0	1	1	1	1	1	0	
	0	0	0	0	0	0	0	0	0	0	0	0	1	1	1	1	1	1	

4.7 DISPLAY POSITIONS

The following table is the coordinates per pixel (See figure of "4.8 SCANNING DIRECTIONS").

C (0, 0)						
R	G	B				
↑						
C(0, 0)	C(1, 0)	...	C(X, 0)	...	C(638, 0)	C(639, 0)
C(0, 1)	C(1, 1)	...	C(X, 1)	...	C(638, 1)	C(639, 1)
⋮	⋮	⋮	⋮	⋮	⋮	⋮
C(0, Y)	C(1, Y)	...	C(X, Y)	...	C(638, Y)	C(639, Y)
⋮	⋮	⋮	⋮	⋮	⋮	⋮
C(0, 478)	C(1, 478)	...	C(X, 478)	...	C(638, 478)	C(639, 478)
C(0, 479)	C(1, 479)	...	C(X, 479)	...	C(638, 479)	C(639, 479)

4.8 SCANNING DIRECTIONS

The following figures are seen from a front view. Also the arrow shows the direction of scan.

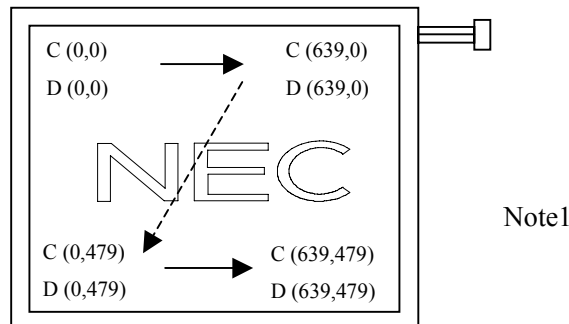

Figure 1. Normal scan (DPS: Low or Open)

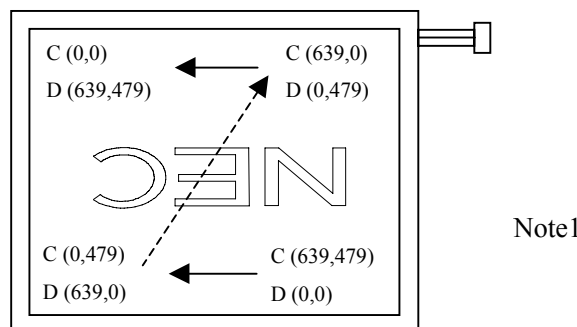

Figure 2. Reverse scan (DPS: High)

Note1: Meaning of C (X, Y) and D (X, Y)

C (X, Y): The coordinates of the display position (See "4.7 DISPLAY POSITIONS".)

D (X, Y): The data number of input signal for LCD panel signal processing board

4.9 INPUT SIGNAL TIMINGS FOR LCD PANEL SIGNAL PROCESSING BOARD

4.9.1 Outline of input signal timings

- Horizontal signal

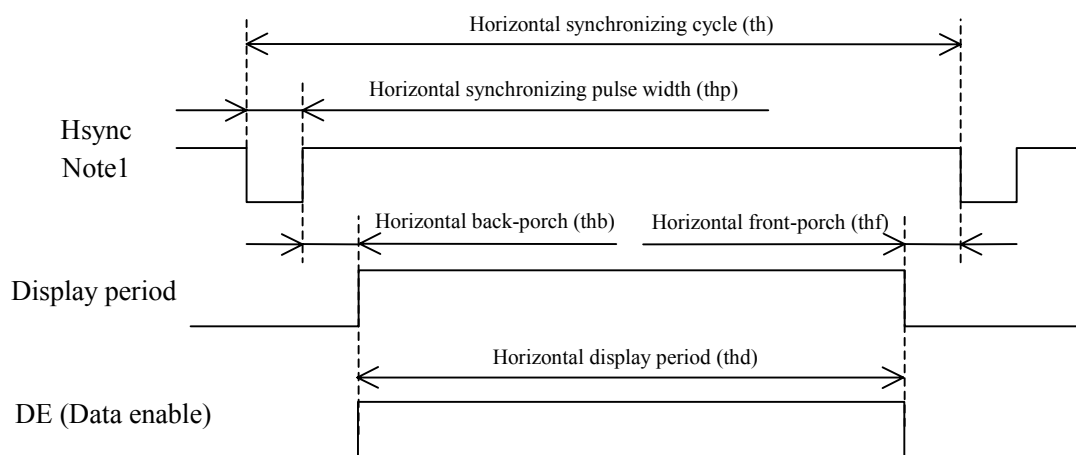

Note1: Fixed mode cannot be used while working of DE mode.

Note2: This diagram indicates virtual signal for set up to timing.

- Vertical signal

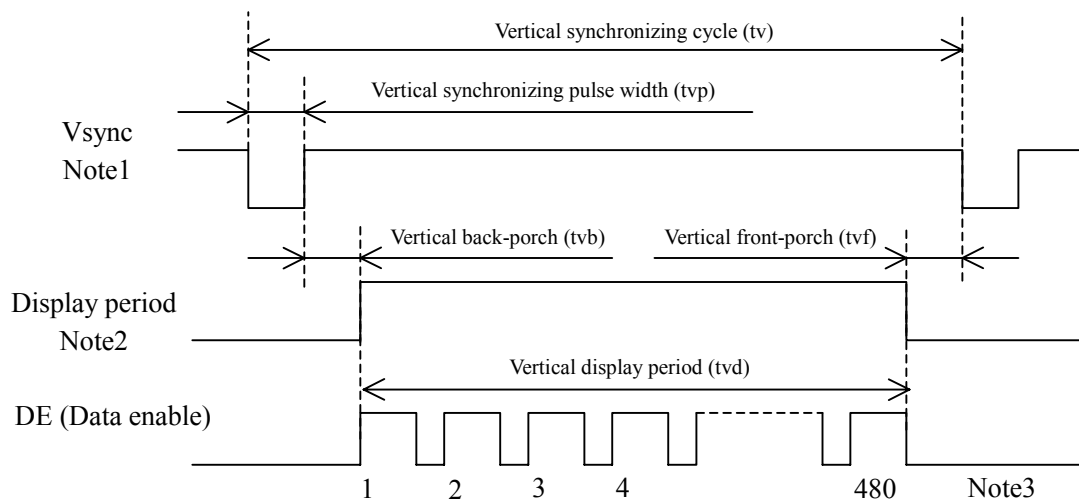

Note1: Fixed mode cannot be used while working of DE mode.

Note2: This diagram indicates virtual signal for set up to timing.

Note3: See "**4.9.3 Input signal timing chart**" for numeration of pulse.

4.9.2 Timing characteristics

(a) Fixed mode

(Note1)

Parameter		Symbol	min.	typ.	max.	Unit	Remarks
CLK	Frequency	1/tc	21.0	25.2	29.0	MHz	39.7 ns (typ.)
	Duty	tcd	0.4	0.5	0.6	-	-
	Rise time, Fall time	terf	-	-	10	ns	
DATA (R0-R5) (G0-G5) (B0-B5)	CLK-DATA	Setup time	tds	8	-	-	ns
		Hold time	tdh	12	-	-	ns
	Rise time, Fall time	tdrf	-	-	10	ns	-
Hsync	Cycle	th	30.0	31.8	33.6	μ s	31.4 kHz (typ.)
			800			CLK	Note2
	Display period	thd	640			CLK	
	Front-porch	thf	16			CLK	
	Pulse width	thp	10	96	-	CLK	
	Back-porch	thb	-	48	134	CLK	
	Total of pulse width and back-porch	thp + thb	144			CLK	
	CLK- Hsync	Setup time	ths	8	-	-	ns
		Hold time	thh	12	-	-	ns
	Rise time, Fall time	thrf	-	-	10	ns	-
Vsync	Cycle	tv	16.1	16.7	17.2	ms	59.9 Hz (typ.)
			525			H	Note2
	Display period	tvd	480			H	
	Front-porch	tvf	12			H	
	Pulse width	tvp	1	-	2	H	
	Back-porch	tvb	31	-	32	H	
	Total of pulse width and back-porch	tvp + tvb	33			H	
	Hsync- Vsync timing	thv	1	-	-	CLK	
	Vsync-Hsync timing	tvh	30	-	-	ns	
Rise time, Fall time	tvrf	-	-	10	ns	-	

Note1: Definition of parameters is as follows.

$$tc = 1\text{CLK}, tcd = tch/tc, th = 1H$$

Note2: Keep tvp + tvb and thp + thb within the table. If it is out of specification, display position will be shifted to right/left side or up/down.

(b) DE mode

(Note1, Note2)

Parameter		Symbol	min.	typ.	max.	Unit	Remarks	
CLK	Frequency	1/tc	21.0	25.2	29.0	MHz	39.7 ns (typ.)	
	Duty	tcd	0.4	0.5	0.6	-		
	Rise time, Fall time	terf	-	-	10	ns		
DATA (R0-R5) (G0-G5) (B0-B5)	CLK-DATA	Setup time	tds	8	-	-	ns	-
		Hold time	tdh	12	-	-	ns	
	Rise time, Fall time	tdrf	-	-	10	ns		
Vsync	Pulse width		typ	1	2	-	H	-
	Vsync-DE timing	Setup time	tvds	1	-	-	CLK	
		Hold time	tvdh	1	-	-	CLK	
	Rise time, Fall time	tvrif	-	-	10	ns		
DE	Horizontal	Cycle	th	30.0	31.8	33.6	μ s	31.4 kHz (typ.)
		Display period	thd	-	800	-	CLK	-
	Vertical (One frame)	Cycle	tv	16.1	16.7	17.2	ms	59.9 Hz (typ.)
		Display period	tvd	-	525	-	H	-
	CLK-DE	Setup time	tdes	8	-	-	ns	-
		Hold time	tdeh	12	-	-	ns	
	Rise time, Fall time	tderf	-	-	10	ns		

Note1: Definition of parameters is as follows.

$$tc = 1\text{CLK}, tcd = tch/tc, th = 1H$$

Note2: Hsync signal (Pin No.3 of CN1) is not used inside the product at DE mode.

Do not keep pin open to avoid noise problem.

4.9.3 Input signal timing chart

(a) Fixed mode

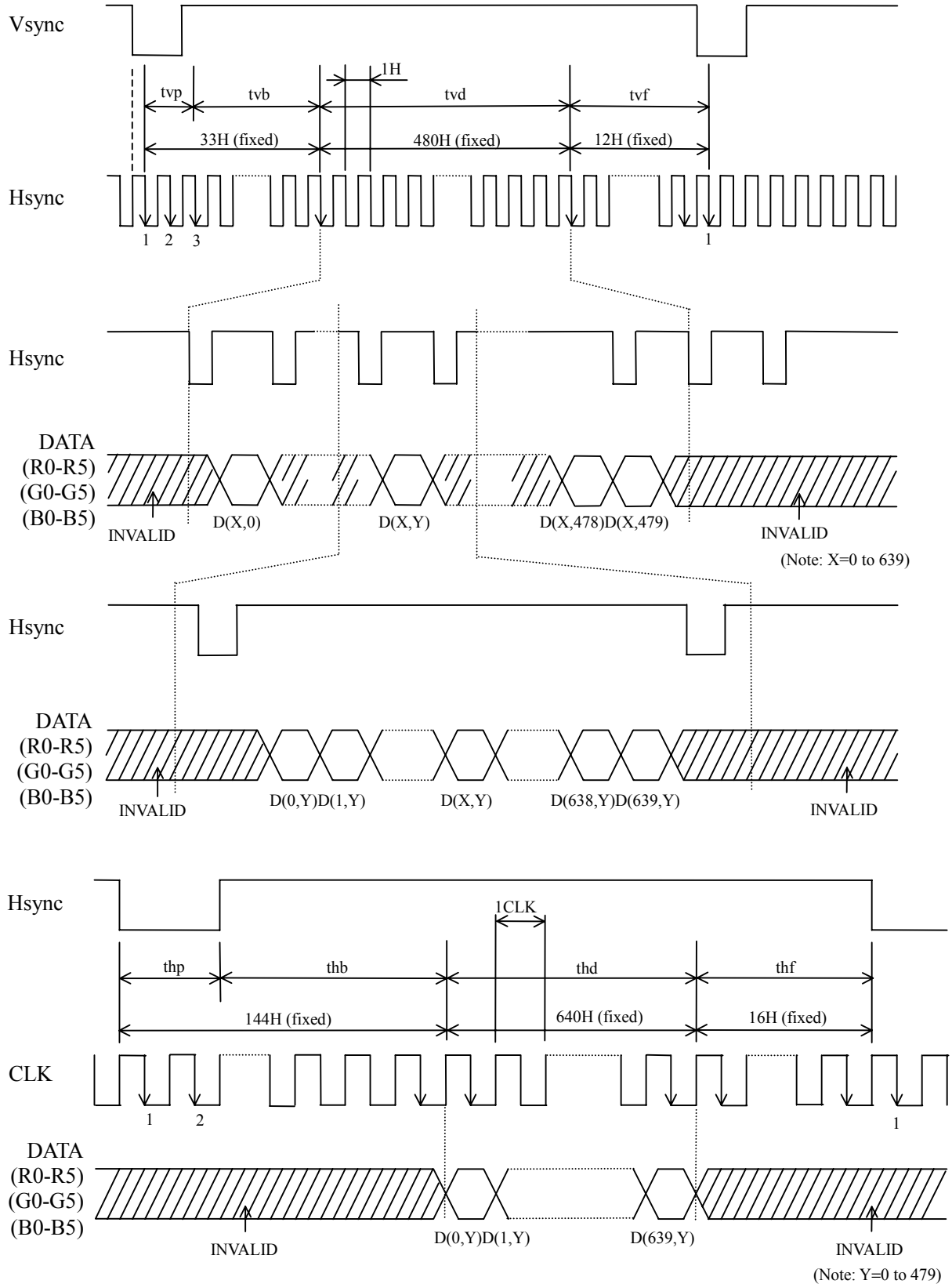

(b) DE mode

Horizontal timing

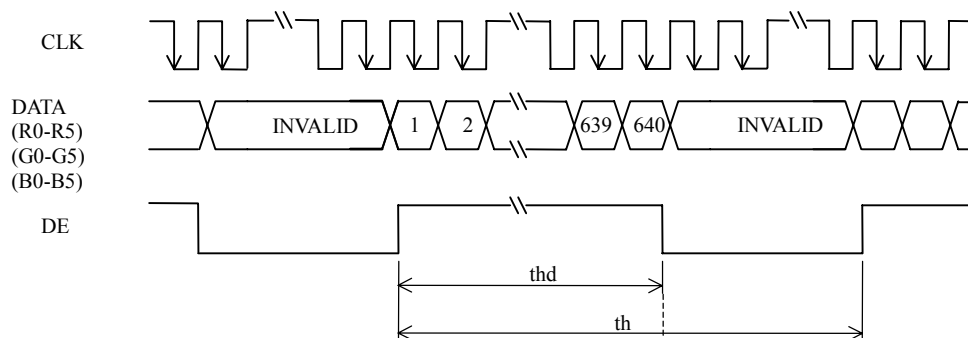

Vertical timing

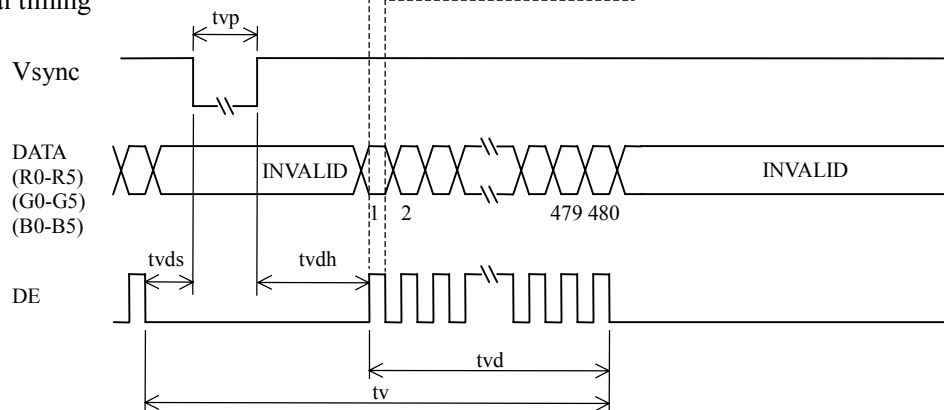

(c) Common

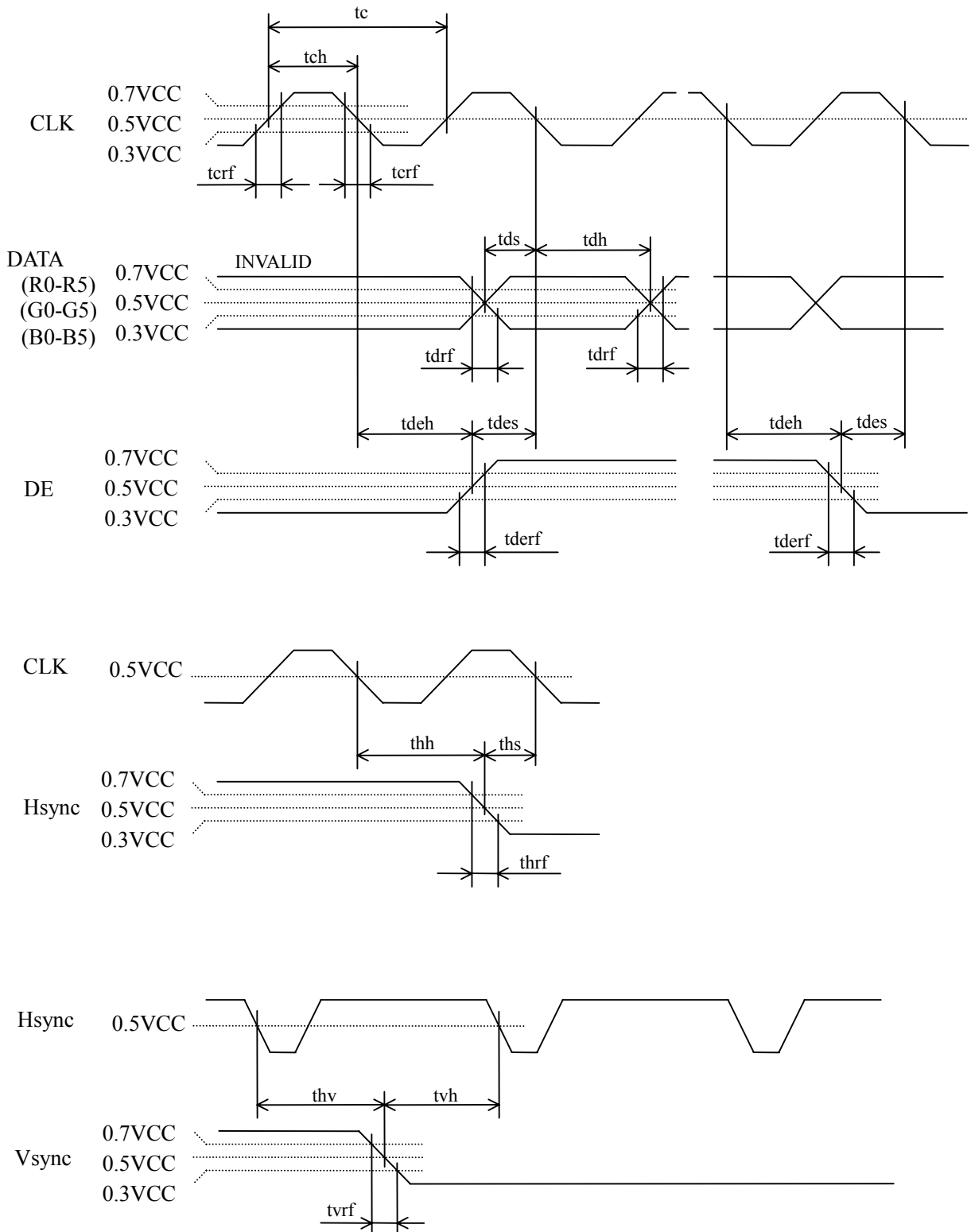

4.10 OPTICS

4.10.1 Optical characteristics for transmissive mode

(Note1, Note2)

Parameter	Condition	Symbol	min.	typ.	max.	Unit	Remarks	
Luminance	White at center $\theta_R = 0^\circ, \theta_L = 0^\circ, \theta_U = 0^\circ, \theta_D = 0^\circ$	L	200	250	-	cd/m ²	-	
Contrast ratio	White/Black at center $\theta_R = 0^\circ, \theta_L = 0^\circ, \theta_U = 0^\circ, \theta_D = 0^\circ$	CR	50	100	-	-	Note3	
Luminance uniformity	-	LU	-	1.25	1.40	-	Note4	
Chromaticity	White	x coordinate	Wx	-	0.303	-	-	Note5
		y coordinate	Wy	-	0.330	-	-	
	Red	x coordinate	Rx	-	0.595	-	-	
		y coordinate	Ry	-	0.362	-	-	
	Green	x coordinate	Gx	-	0.312	-	-	
		y coordinate	Gy	-	0.558	-	-	
	Blue	x coordinate	Bx	-	0.155	-	-	
		y coordinate	By	-	0.130	-	-	
Color gamut	$\theta_R = 0^\circ, \theta_L = 0^\circ, \theta_U = 0^\circ, \theta_D = 0^\circ$ at center, against NTSC color space	C	40	50	-	%		
Response time	White to black	Ton	-	5	15	ms	Note6 Note7	
	Black to white	Toff	-	20	40	ms		
Viewing angle	Right	$\theta_U = 0^\circ, \theta_D = 0^\circ, CR = 10$	θ_R	-	55	-	°	Note8
	Left	$\theta_U = 0^\circ, \theta_D = 0^\circ, CR = 10$	θ_L	-	75	-	°	
	Up	$\theta_R = 0^\circ, \theta_L = 0^\circ, CR = 10$	θ_U	-	40	-	°	
	Down	$\theta_R = 0^\circ, \theta_L = 0^\circ, CR = 10$	θ_D	-	55	-	°	

Note1: These are initial characteristics.

Note2: Measurement conditions are as follows.

Ta = 25°C, VCC = 3.3V, IBL = 5.0mA rms/lamp, Display mode: VGA, Horizontal cycle = 31.4kHz, Vertical cycle = 59.9Hz, DPS= Low or open: Normal scan.

Optical characteristics are measured at luminance saturation after 20minutes from working the product, in the dark room. Also measurement method for luminance is as follows.

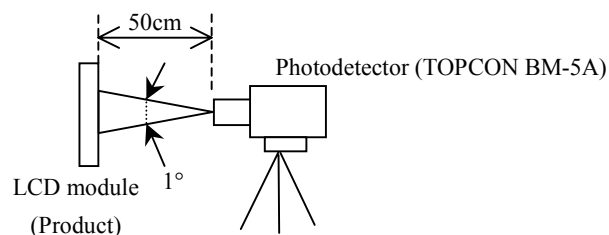

Note3: See "4.10.2 Definition of contrast ratio".

Note4: See "4.10.3 Definition of luminance uniformity".

Note5: These coordinates are found on CIE 1931 chromaticity diagram.

Note6: Product surface temperature: TopF = 25°C

Note7: See "4.10.4 Definition of response times".

Note8: See "4.10.5 Definition of viewing angles".

4.10.2 Definition of contrast ratio

The contrast ratio is calculated by using the following formula.

$$\text{Contrast ratio (CR)} = \frac{\text{Luminance of white screen}}{\text{Luminance of black screen}}$$

4.10.3 Definition of luminance uniformity

The luminance uniformity is calculated by using following formula.

$$\text{Luminance uniformity (LU)} = \frac{\text{Maximum luminance from ① to ⑤}}{\text{Minimum luminance from ① to ⑤}}$$

The luminance is measured at near the 5 points shown below.

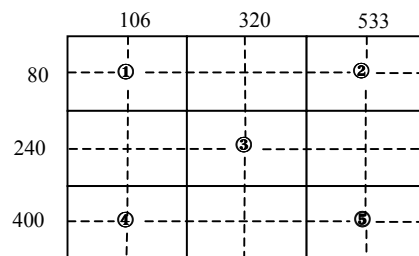

4.10.4 Definition of response times

Response time is measured, the luminance changes from "white" to "black", or "black" to "white" on the same screen point, by photo-detector. Ton is the time it takes the luminance change from 90% down to 10%. Also Toff is the time it takes the luminance change from 10% up to 90% (See the following diagram.).

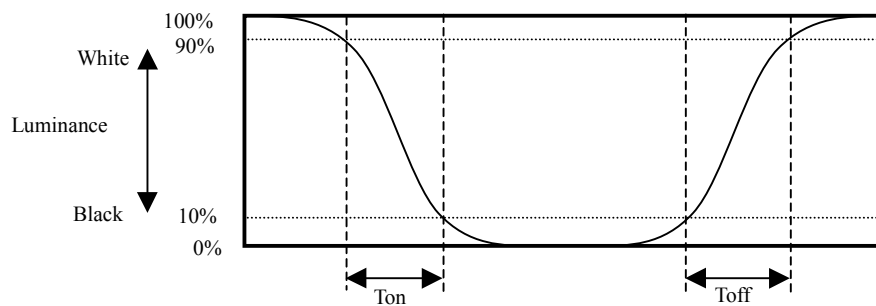

4.10.5 Definition of viewing angles

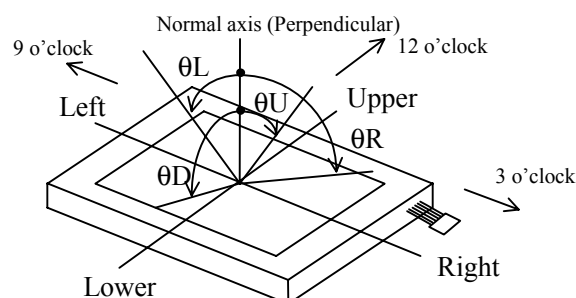

4.10.6 Optical characteristics for reflective mode

(Note1)

Parameter	Condition	Symbol	min.	typ.	max.	Unit	Remarks
Contrast ratio	White/Black at center $\theta_R = 0^\circ, \theta_L = 0^\circ, \theta_U = 0^\circ, \theta_D = 0^\circ$	CR	-	8	-	-	Note2, 3
Reflectance	White at center $\theta_R = 0^\circ, \theta_L = 0^\circ, \theta_U = 0^\circ, \theta_D = 0^\circ$	R	-	5.0	-	%	Note2, 4
Color gamut	$\theta_R = 0^\circ, \theta_L = 0^\circ, \theta_U = 0^\circ, \theta_D = 0^\circ$ at center, against NTSC color space	C	-	30	-	%	Note5, 6

Note1: Measurement conditions are as follows.

 $T_a = 25^\circ\text{C}$, VCC = 3.3V, Display mode: VGA, Horizontal cycle = 31.4kHz, Vertical cycle = 59.9Hz, DPS= Low or open: Normal scan

Optical characteristics are measured at luminance saturation for measurement light source after 1 hour from working the product, in the dark room.

Note2: Measurements of contrast ratio and reflectance

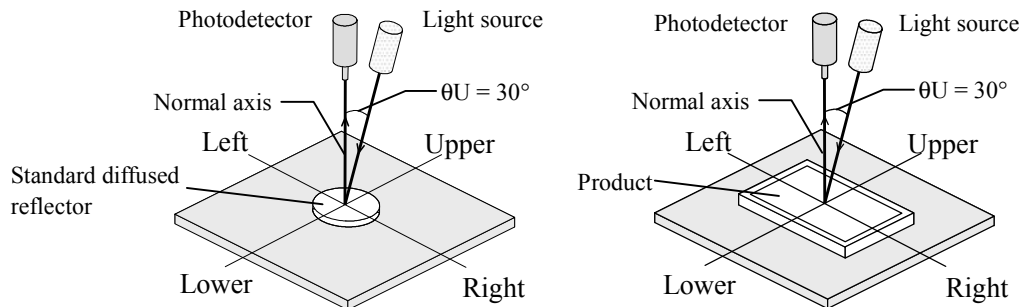

Note3: Definitions of contrast ratio

The contrast ratio is calculated by using the following formula.

$$\text{Contrast ratio (CR)} = \frac{\text{Luminance of white screen}}{\text{Luminance of black screen}}$$

Note4: Definitions of reflectance

The reflectance is calculated by using the following formula.

$$\text{Reflectance (R)} = \frac{\text{Luminance of reflection at white screen}}{\text{Luminance of standard diffused reflector}} \times 100$$

Note5: Measurements of color gamut

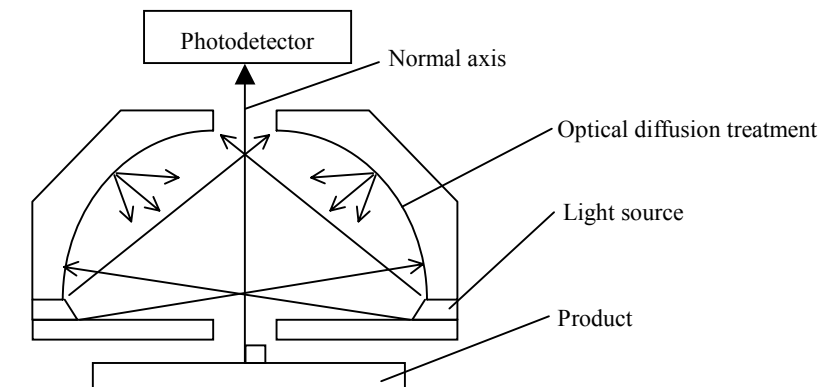

Note6: These coordinates are found on CIE 1931 chromaticity diagram.

5. RELIABILITY TESTS

Test item	Condition	Judgement
High temperature and humidity (Operation)	① $55 \pm 2^\circ\text{C}$, RH = 85%, 240hours ② Display data is black.	No display malfunctions Note1
High temperature (Operation)	① $65 \pm 2^\circ\text{C}$, 240hours ② Display data is black.	
Heat cycle (Operation)	① $0 \pm 3^\circ\text{C}$...1hour $55 \pm 3^\circ\text{C}$...1hour ② 50cycles, 4hours/cycle ③ Display data is black.	
Thermal shock (Non operation)	① $-20 \pm 3^\circ\text{C}$...30minutes $80 \pm 3^\circ\text{C}$...30minutes ② 100cycles, 1hour/cycle ③ Temperature transition time is within 5 minutes.	
ESD (Operation)	① 150pF, 150Ω, $\pm 10\text{kV}$ ② 9 places on a panel surface Note2 ③ 10 times each places at 1 sec interval	
Dust (Operation)	① Sample dust: No. 15 (by JIS-Z8901) ② 15 seconds stir ③ 8 times repeat at 1 hour interval	
Vibration (Non operation)	① 5 to 100Hz, 19.6m/s^2 ② 1 minute/cycle ③ X, Y, Z direction ④ 120 times each directions	
Mechanical shock (Non operation)	① 539m/s^2 , 11ms ② $\pm X, \pm Y, \pm Z$ direction ③ 3 times each directions	

Note1: Display and appearance are checked under environmental conditions equivalent to the inspection conditions of defect criteria. ☆

Note2: See the following figure for discharge points.

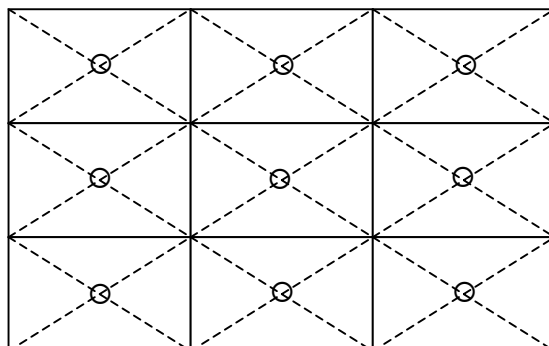

6. PRECAUTIONS

6.1 MEANING OF CAUTION SIGNS

The following caution signs have very important meaning. **Be sure to read "6.2 CAUTIONS" and "6.3 ATTENTIONS", after understanding this contents!**



This sign has the meaning that customer will be injured by himself or the product will sustain a damage, if customer has wrong operations.



This sign has the meaning that customer will get an electrical shock, if customer has wrong operations.



This sign has the meaning that customer will be injured by himself, if customer has wrong operations.

6.2 CAUTIONS



*** Do not touch the working backlight. Customer will be in danger of an electric shock.**



*** Do not touch the working backlight. Customer will be in danger of burn injury.
* Do not shock and press the LCD panel and the backlight! There is a danger of breaking, because they are made of glass. (Shock: To be not greater 539m/s² and to be not greater 11ms, Pressure: To be not greater 19.6 N)**

6.3 ATTENTIONS



6.3.1 Handling of the product

- ① Take hold of both ends without touch the circuit board when customer pulls out products (LCD modules) from inner packing box. If customer touches it, products may be broken down or out of adjustment, because of stress to mounting parts.
- ② Do not hook cables nor pull connection cables such as lamp cable and so on, for fear of damage.
- ③ If customer puts down the product temporarily, the product puts on flat subsoil as a display side turns down.
- ④ Take the measures of electrostatic discharge such as earth band, ionic shower and so on, when customer deals with the product, because products may be damaged by electrostatic.
- ⑤ The torque for mounting screws must never exceed 0.29N·m. Higher torque values might result in distortion of the bezel.
- ⑥ The product must be installed using mounting holes without undue stress such as bends or twist (See outline drawings). And do not add undue stress to any portion (such as bezel flat area) except mounting hole portion.
Bends or twist described above and undue stress to any portion except mounting hole portion may cause display un-uniformity.

☆

- ⑦ Do not press or rub on the sensitive display surface. If customer clean on the panel surface, NEC recommends using the cloth with ethanolic liquid such as screen
- ⑧ Do not push-pull the interface connectors while the product is working, because wrong power sequence may break down the product.
- ⑨ Do not bend or unbend the lamp cable at the near part of the lamp holding rubber, to avoid the damage for high voltage side of the lamp. This damage may cause a lamp breaking and abnormal operation of high voltage circuit.

6.3.2 Environment

- ① Do not operate or store in high temperature, high humidity, dewdrop atmosphere or corrosive gases. Keep the product in antistatic pouch in room temperature, because of avoidance for dusts and sunlight, if customer stores the product.
- ② In order to prevent dew condensation occurring by temperature difference, the product packing box must be opened after leave under the environment of an unpacking room temperature enough. Because a situation of dew condensation occurring is changed by the environmental temperature and humidity, evaluate the leaving time sufficiently. (Recommendation leaving time: 6 hour or more with packing state) ☆
- ③ Do not operate in high magnetic field. Circuit boards may be broken down by it.
- ④ This product is not designed as radiation hardened. ☆
- ⑤ Use an original protection sheet on the product surface (polarizer). Adhesive type protection sheet should be avoided, because it may change color or properties of the polarizer.

6.3.3 Characteristics

The following items are neither defects nor failures.

- ① Response time, luminance and color may be changed by ambient temperature.
- ② The LCD may be seemed luminance non-uniformity, flicker, vertical seam or small spot by display patterns.
- ③ Optical characteristics (e.g. luminance, display uniformity, etc.) gradually is going to change depending on operating time, and especially low temperature, because the LCD has cold cathode fluorescent lamps.
- ④ Do not display the fixed pattern for a long time because it may cause image sticking. Use a screen saver, if the fixed pattern is displayed on the screen.
- ⑤ The display color may be changed by viewing angle because of the use of condenser sheet in the backlight unit.
- ⑥ Optical characteristics may be changed by input signal timings.
- ⑦ The interference noise of input signal frequency for this product's signal processing board and luminance control frequency of customer's backlight inverter may appear on a display. Set up luminance control frequency of backlight inverter so that the interference noise does not appear.
- ⑧ Each of color of the polarizer surface at non-operation may differ because of antireflection treatment.

6.3.4 Other

- ① All GND, backlight inverter ground (GNDB), VCC and backlight inverter power supply voltage (VDDDB) terminals should be used without a non-connected line.
- ② Do not disassemble a product or adjust volume without permission of NEC.
- ③ See "REPLACEMENT MANUAL FOR LAMPHOLDER SET", if customer would like to replace backlight lamps.
- ④ Pay attention not to insert waste materials inside of products, if customer uses screwnails.
- ⑤ Pack the product with original shipping package, because of avoidance of some damages during transportation, when customer returns it to NEC for repair and so on.

7. OUTLINE DRAWINGS

7.1 FRONT VIEW

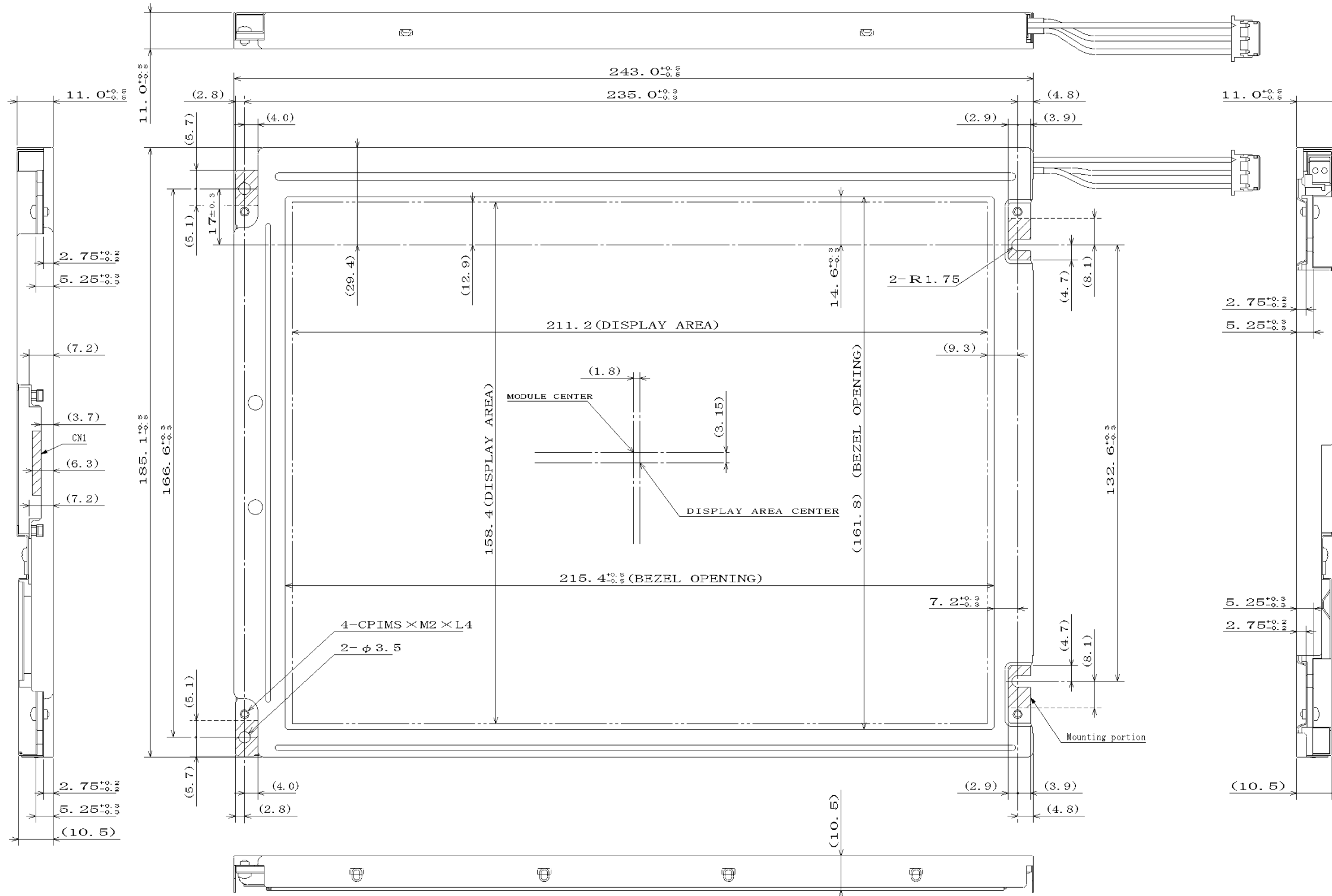

Note1: The values in parentheses are for reference.
 Note2: The torque for mounting screw should never exceed 0.29N·m.

Unit: mm

7.2 REAR VIEW

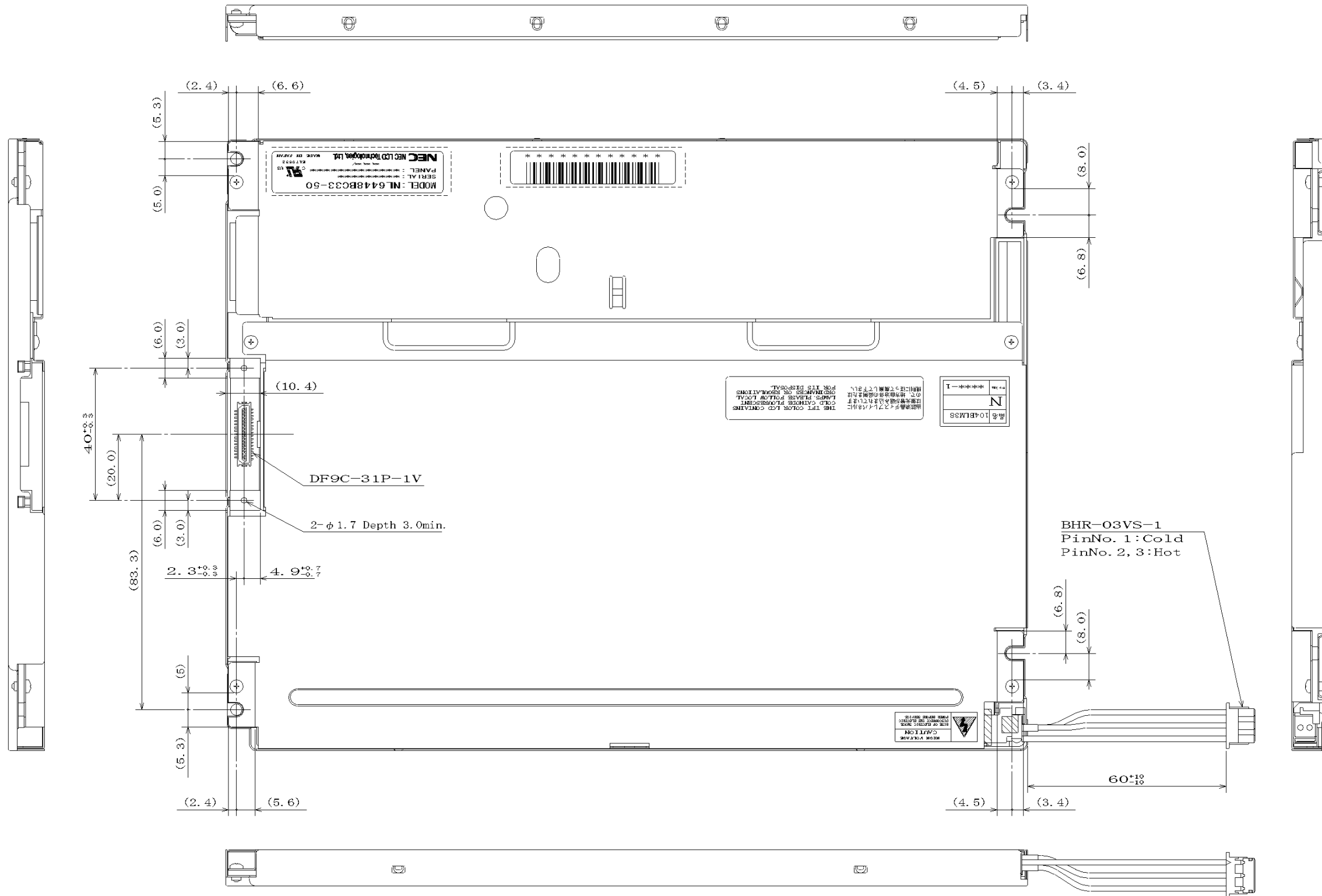

Note1: The values in parentheses are for reference.
 Note2: The torque for mounting screw should never exceed 0.29N·m.

Unit: mm